



GYNECOLOGY / OBSTETRICS





VAGINAL SPECULA

Vaginalspekula
Especulos vaginales

Spéculums vaginaux
Specoli vaginali



GRAVES
LG14-001-001
75 x 20 mm Small
LG14-002-002
95 x 35 mm Medium
LG14-003-003
115 x 35 mm Large



PEDERSON
LG14-004-001
75 x 13 mm Small
LG14-005-002
100 x 22 mm Medium
LG14-006-003
120 x 25 mm Large



**GRAVES VAGINAL
SPECULUM Leep / Lietz**
LG14-007-004 Small
LG14-008-005 Medium
LG14-009-006 Large
LG14-010-007 X-large



**PEDERSON VAGINAL
SPECULUM Leep / Lietz**
LG14-011-008 Small
LG14-012-009 Medium
LG14-013-010 Large
LG14-014-011 X-Large



VAGINAL SPECULA

Vaginalspekula
Espéculos vaginales

Spéculums vaginaux
Specoli vaginali



DE VILBISS
LG14-015-001
4 x 27 mm
102 mm x 32 mm
Medium



SEYFFERT
LG14-016-230 100 x 24 mm
LG14-017-230 110 x 32 mm
230 mm



CUSCO
LG14-018-001 75 x 32 mm
LG14-019-002 85 x 35 mm
LG14-020-003 100 x 35 mm



CUSCO
LG14-021-004 75 x 17 mm



CUSCO
LG14-022-001 90 x 22 mm
LG14-023-002 100 x 25 mm
LG14-024-003 105 x 27 mm



VAGINAL SPECULA

Vaginalspekula
Especulos vaginales

Spéculums vaginaux
Specoli vaginali



CUSCO

LG14-025-001 75 x 32 mm
LG14-026-002 85 x 35 mm
LG14-027-003 100 x 37 mm



COLLIN

LG14-028-001 85 x 30 mm
LG14-029-002 100 x 35 mm
LG14-030-003 110 x 40 mm



SEMM

LG14-031-001 100 x 17 / 20 mm
LG14-032-002 105 x 27 / 30 mm



COLLIN
LG14-033-001
55 x 10 mm



TRELAT

LG14-034-001 85 mm 33 mm
LG14-035-002 95 mm 35 mm
LG14-036-003 115 mm 43 mm



WINTERTON
LG14-037-001



NOTT
LG14-038-001 90 mm 30 mm
LG14-039-002 100 mm 30 mm



VAGINAL SPECULA (UPPER AND LOWER BLADES)

Vaginalspekula
Espéculos vaginales

Spéculums vaginaux
Specoli vaginali

LG14-041-215
115x14 mm
21.5 cm, 8 ½"

LG14-042-215
115x16 mm
21.5 cm, 8 ½"

LG14-043-215
115x23 mm
21.5 cm, 8 ½"

LG14-044-215
115x26 mm
21.5 cm, 8 ½"

LG14-045-225
115x26 mm
22.5 cm, 9"

LG14-047-215
110x18 mm
21.5 cm, 8 ½"

LG14-048-215
110x20 mm
21.5 cm, 8 ½"

LG14-049-215
110x27 mm
21.5 cm, 8 ½"

LG14-050-220
110x30 mm
22.0 cm, 8 ¾"

LG14-051-225
110x36 mm
22.5 cm, 9"

KRISTELLER
LG14-040-001
Upper Blades

KRISTELLER
LG14-046-001
Lower Blades

S I N C E 1 9 8 1



VAGINAL SPECULA

Vaginalspekula
Especulos vaginales

Spéculums vaginaux
Specoli vaginali

LG14-053-205
80 x 28 mm

LG14-057-175
76 x 38 mm

LG14-054-205
85 x 35 mm

LG14-058-175
89 x 38 mm

LG14-055-205
85 x 40 mm

LG14-059-175
102 x 38 mm

Slightly Concave

Slightly Concave

KRISTELLER
LG14-052-205
20.5 cm, 8"

JACKSON
LG14-056-175
17.5 cm, 7"

SINCE 1981



VAGINAL SPECULUM

Vaginalspekula
Especulos vaginales

Spéculums vaginaux
Specoli vaginali

56 x 13 mm



BRAUN
LG14-060-180
18 cm, 7"

60 x 10 mm



BRAUN
LG14-061-180
18 cm, 7"



LG14-062-280
Handle with cold light
carrier for upper blades
28 cm, 11"

95 x 17-26 mm



SIMON
LG14-063-275
115 x 22 mm
27.5 cm, 10 3/4"

1/2



MATHIEU
LG14-064-210
For children and
virgins fitting
21 cm, 8 1/2"

95 x 17 - 30 mm



MATHIEU
LG14-065-210
For children
and virgins
21 cm, 8 1/2"

S I N C E 1 8 1



VAGINAL SPECULA, VAGINAL RETRACTORS

Vaginalspekula, scheidenhalter
Especulos vaginales, valvas vaginales

Spéculum vaginaux, valves vaginales
Specoli vaginali, valve vaginali



BRIESKY
LG14-066-170 72x25 mm / 77x30 mm
LG14-067-170 75x30 mm / 92x38 mm
17 cm, 6 3/4"



KALLMORGEN VAGINAL SPECULUM
LG14-068-200 70 x 40 mm
LG14-069-200 90 x 40 mm
20 cm, 8"



KALLMORGEN VAGINAL RETRACTOR
LG14-070-200 70 x 33 mm
LG14-071-200 90 x 33 mm
20 cm, 8"



MATHIEU Vaginal Retractor
LG14-072-210 95 x 16 mm
LG14-073-210 95 x 26 mm
LG14-074-210 95 x 30 mm
21 cm, 8 1/2"



MATHIEU Vaginal Retractor
LG14-075-220 100 x 11 mm
LG14-076-220 100 x 14 mm
LG14-077-220 100 x 20 mm
LG14-078-220 100 x 26 mm
22 cm, 8 3/4"



DOYEN VAGINAL SPECULUM
22 cm, 8 3/4"



Slightly Concave

LG14-079-220 60 x 35 mm
LG14-080-220 90 x 35 mm
LG14-081-220 120 x 35 mm
LG14-082-220 60 x 45 mm
LG14-083-220 90 x 45 mm
LG14-084-220 120 x 45 mm
LG14-085-220 160 x 45 mm
LG14-086-220 60 x 60 mm
LG14-087-220 90 x 60 mm
LG14-088-220 120 x 60 mm
LG14-089-220 160 x 60 mm



LANDON VAGINAL RETRACTOR
LG14-090-090
Blade 9 cm
Deep 2.5 cm wide.



VAGINAL SPECULA (FOR CHILDREN AND VIRGINS)

Vaginalspekula
Espéculos vaginales

Spéculums vaginaux
Specoli vaginali

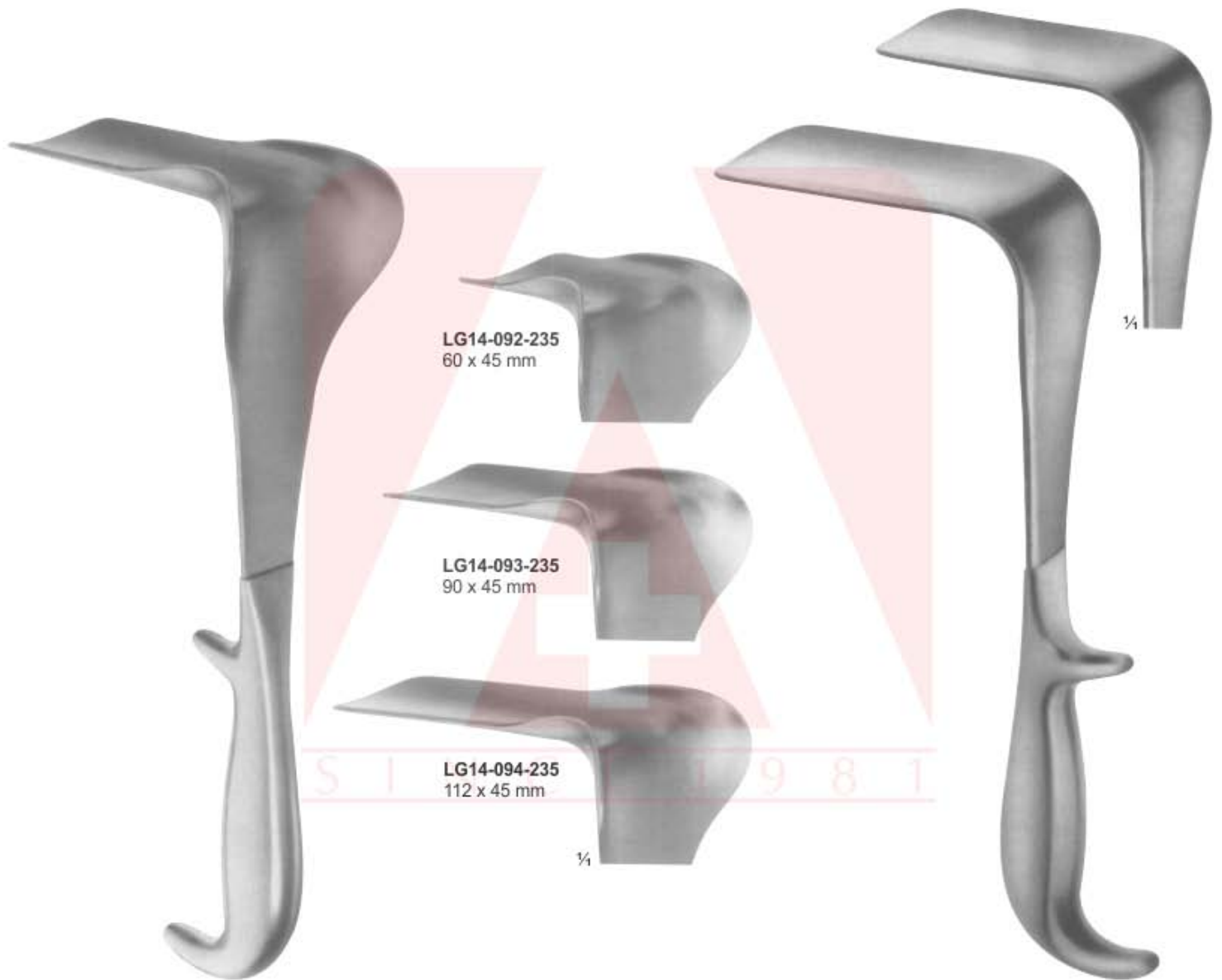

LG14-092-235
60 x 45 mm

LG14-093-235
90 x 45 mm

LG14-094-235
112 x 45 mm

DOYEN
LG14-091-235
23.5 cm, 9 1/4"

	Length of blades	Width of blades
LG14-095-190	60 mm	35 mm
LG14-096-190	90 mm	45 mm
LG14-097-190	120 mm	60 mm
LG14-098-190	160 mm	70 mm
	19 cm, 7 1/2"	



VAGINAL SPECULA & RETRACTORS

Vaginalspekula, scheidenhalter
Especulos vaginales, valvas vaginales

Spéculums vaginaux, valves vaginales
Specoli vaginali, valve vaginali



**BREISKY
WIENER MODELL/
VIENNA PATTERN**

LG14-099-300 100 x 20 mm
LG14-100-300 100 x 25 mm
LG14-101-300 100 x 30 mm
LG14-102-300 100 x 35 mm
LG14-103-300 100 x 40 mm
30 cm, 12"



**BREISKY
WIENER MODELL/
VIENNA PATTERN**

LG14-104-320 130 x 20 mm
LG14-105-320 130 x 25 mm
LG14-106-320 130 x 30 mm
LG14-107-320 130 x 35 mm
LG14-108-320 130 x 40 mm
32 cm, 12 1/2"



LANDAU

LG14-109-300 105 x 28 mm
LG14-110-300 105 x 38 mm
30 cm, 12"



WEISSBARTH

LG14-111-210 80 x 28 mm
LG14-112-210 85 x 42 mm
21 cm, 8 1/4"



DOYEN

Lateral Speculum
LG14-113-250 80 x 30 mm
25 cm, 10"



VAGINAL SPECULA

Vaginalspekula
Espéculos vaginales

Spéculums vaginaux
Specoli vaginali

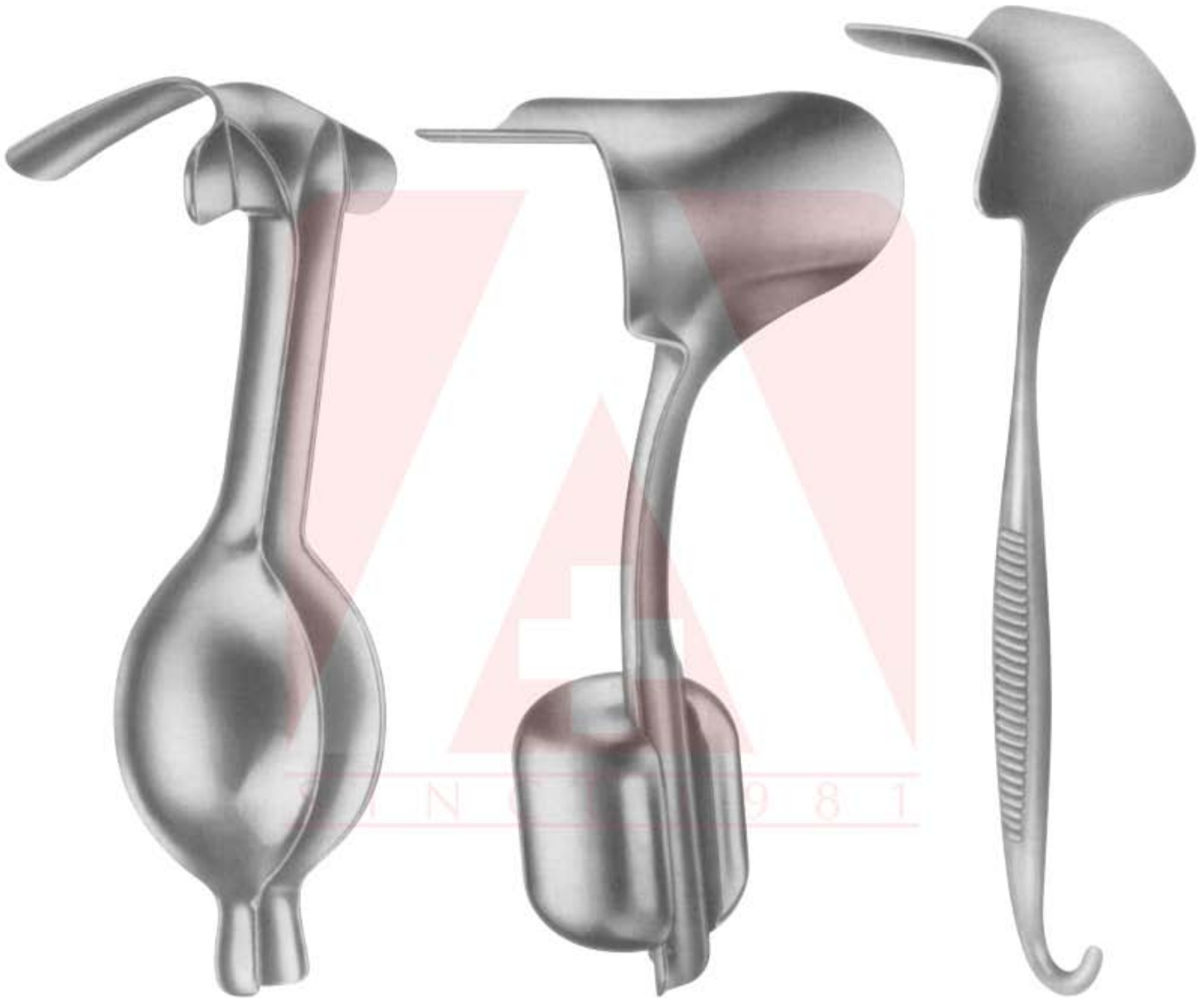

AUVARD
LG14-114-230
65 x 38 mm - 28 mm
1,530 kg
with fixed weight
23 cm, 9"

AUVARD
LG14-115-230 75 x 42 mm
(40 mm)
LG14-116-230 105 x 43 mm
(40 mm)
with detachable weight
23 cm, 9"

MARTIN
LG14-117-270
with hook shaped
handle for hanging
in weights
27 cm, 10 3/4"



VAGINAL SPECULA

Vaginalspekula
Especulos vaginales

Spéculums vaginaux
Specoli vaginali

LG14-118-001
80 x 30

LG14-119-002
85 x 35

LG14-120-003
85 x 40

LG14-124-001
80 x 30 mm

LG14-125-002
85 x 33 mm

LG14-126-003
100 x 38 mm

LG14-127-004
110 x 42 mm

LG14-121-004
55 x 40 - 60 mm

LG14-122-005
70 x 45 - 70 mm

LG14-128-005
65 x 30 mm

LG14-129-006
75 x 35 mm

LG14-130-007
85 x 35 mm

LG14-131-008
95 x 35 mm

SCHERBACK
LG14-123-006
Set consisting of:
handle
weight
5 blades

SCHERBACK
LG14-132-009
Set consisting of:
2 handle
8 blades



UTERIN SOUNDS, VAGINAL SPECULUM

*Uterussonden, Vaginalspekula
histerómetros, Espéculos vaginales,*

*Hystéromètres, Spécuments vaginaux,
isterometri, Specoli vaginali,*

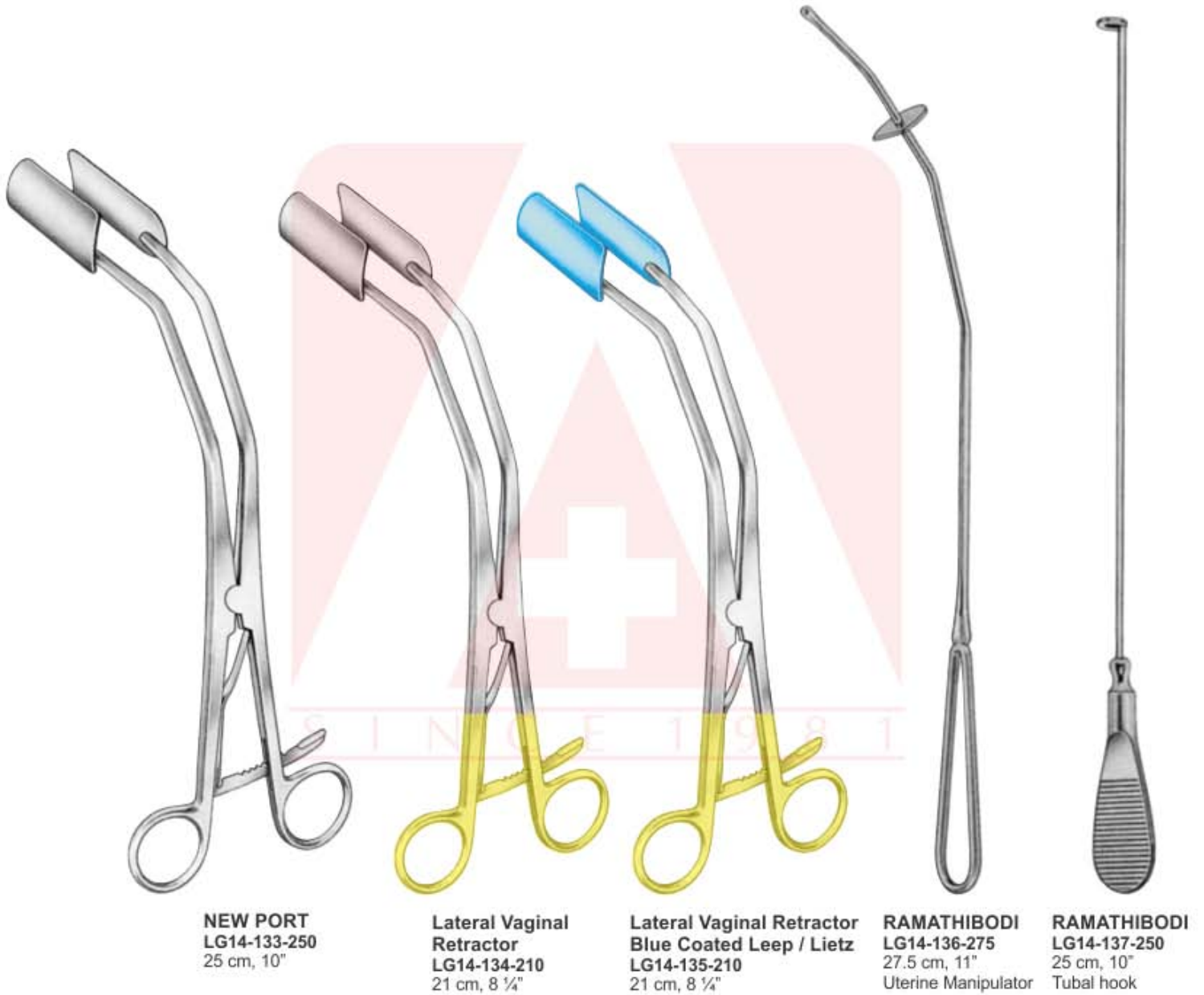

NEW PORT
LG14-133-250
25 cm, 10"

Lateral Vaginal Retractor
LG14-134-210
21 cm, 8 ¼"

**Lateral Vaginal Retractor
Blue Coated Leep / Lietz**
LG14-135-210
21 cm, 8 ¼"

RAMATHIBODI
LG14-136-275
27.5 cm, 11"
Uterine Manipulator

RAMATHIBODI
LG14-137-250
25 cm, 10"
Tubal hook



VAGINAL SPECULUM

Vaginalsepekula
Espéculos vaginales

Spéculums vaginaux
Specoli vaginali

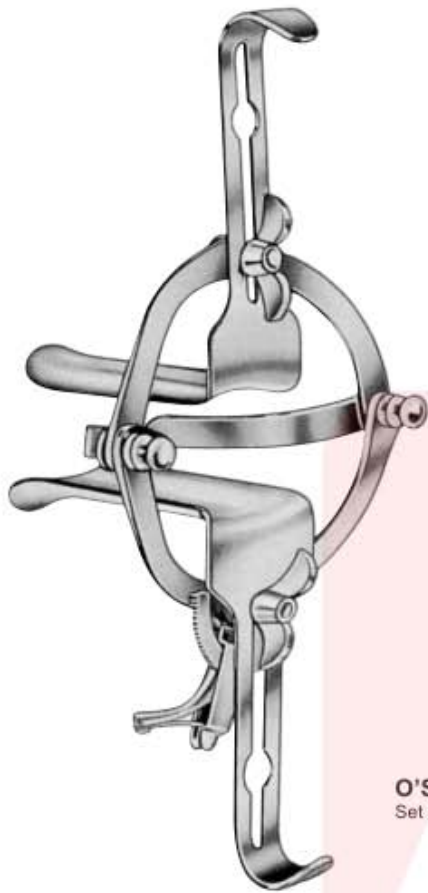

LG14-139-002
45 x 17 mm



LG14-140-003
90 x 37 mm



LG14-141-004
90 x 45 mm

O'SULLIVAN - O'CONNOR
Set of Complete
LG14-138-001
LG14-139-002
LG14-140-003
LG14-141-004



ABDOMINAL RETRACTOR
LG14-142-090 9 cm, 3 1/2" wide
LG14-143-100 10 cm, 4" wide
LG14-144-115 11.5 cm, 4 1/2" wide



FRIEDMANN
LG14-145-100
10 cm, 4"



UTERINE TENACULUM FORCEPS

Hakenzangen, amniotom

Pinza para cuello uterino, amniótomo

Pince pour le col de l'utérus, amniotome

Pinza per il collo dell'utero, amniotomo

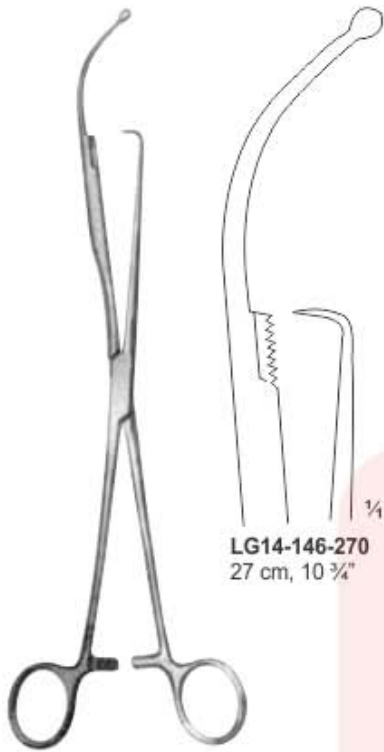

LG14-146-270
27 cm, 10 3/4"

HULKA GYNE



LG14-147-240
24 cm, 9 1/2"
With ratchet
3 mm

KOGAN GYNE

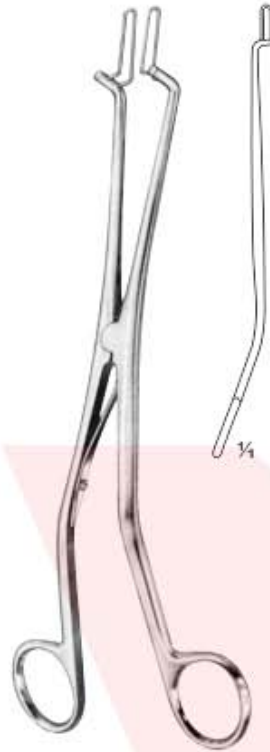

KOGAN
LG14-148-240
24 cm, 9 1/2"

KOGAN
LG14-149-240
24 cm, 9 1/2"

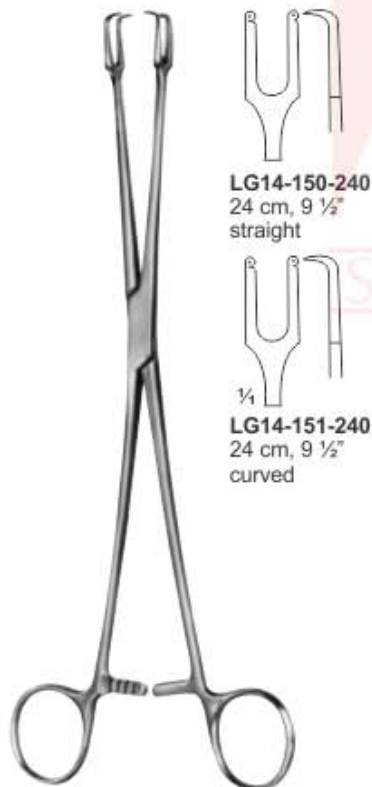

LG14-150-240
24 cm, 9 1/2"
straight

LG14-151-240
24 cm, 9 1/2"
curved

SCHRÖDER GYNE



LG14-152-250
25 cm, 10"

SCHRÖDER

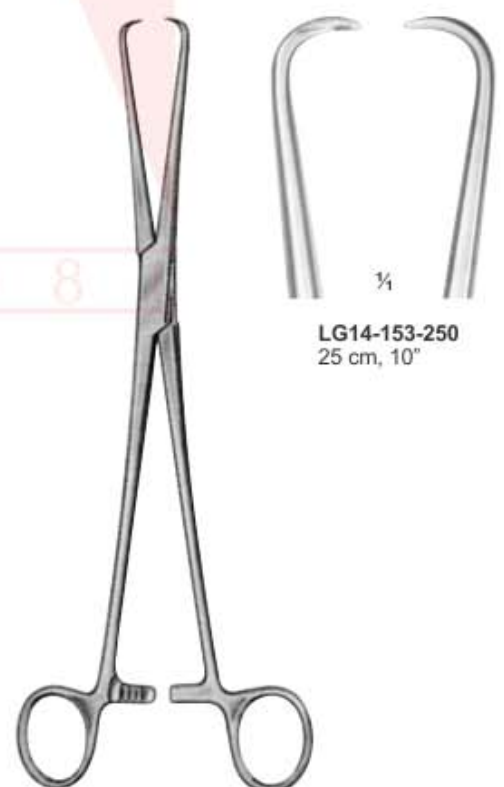

LG14-153-250
25 cm, 10"

POZZI GYNE



UTERINE TENACULUM & UTERINE POLYPUS FORCEPS

Hakenzangen, Uterus-Polypen zangen

Pince pour le col de l'utérus, pinces a ploypes utérins

Pinza para cuello uterino, Pinzas para polipos uterinos Pinza per il collo dell'utero, Pinze per polipi uterini



BARRETT
LG14-154-180
18 cm, 7"



SAIRGES
LG14-155-230
23 cm, 9"



MUSEUX
24 cm, 9 1/2"



LG14-156-240
6 mm



LG14-157-240
8 mm



LG14-158-240
10 mm

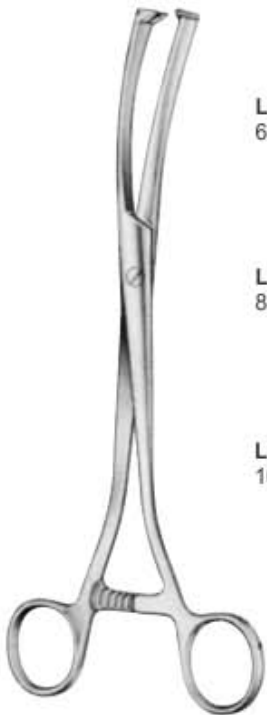

MUSEUX
24 cm, 9 1/2"



LG14-159-240
6 mm



LG14-160-240
8 mm



LG14-161-240
10 mm

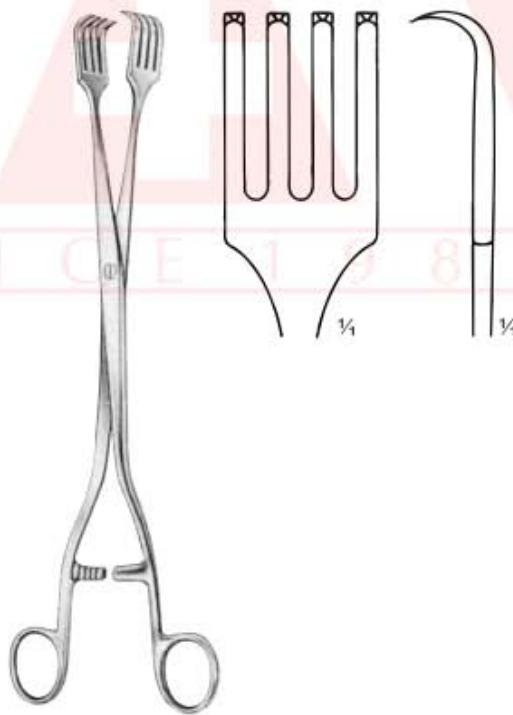

PRATT
LG14-162-280
28 cm, 11"



TEALE
LG14-163-230
23 cm, 9"



MYOMA SCREWS, MYOMA KNIFE, UTERINE SEIZING FORCEPS

Myomheber, Myommesser, Uterusfasszange

Tracteurs pour fibromes, evideur de fibromes, Pincés hystérolabes

Tirabuzones para fibroma, cuchillo para fibroma, Histerólabos Tiramiomi, bisturi per fibromi, Pinze isterolabi



JACOBS
LG14-164-210
21 cm, 8 1/4"
Straight



IOWA
LG14-165-260
26 cm, 10 1/4"



DARTIGUES
LG14-166-270
27 cm, 10 1/2"

For polypus forcepssee
Section 6.



DOYEN
LG14-167-170
17 cm, 6 3/4"



DOYEN
LG14-168-140
14 cm, 5 1/2"

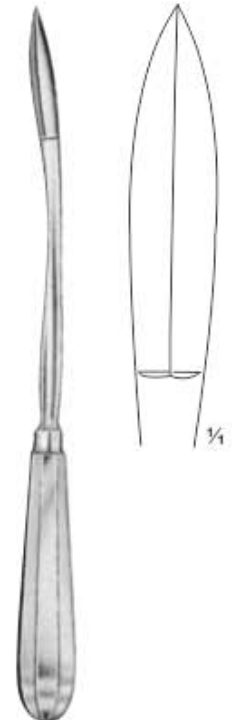

SECOND
LG14-169-270
27 cm, 10 1/2"

S I N C E 1 9 8 1



UTERINE SCOOPS, SUCTION CURETTES & UTERINE DEPRESSOR

Uteruslöffel, Absaugküretten, uterusdepressor

Cucharillas uterinas, Curetas aspiradoras, depresor uterino

Curettes uterines, curettes d'aspiration, Dépresseur utérin

Curette uterine, curette pe aspirazione, depressore uterino



BRAUN
LG14-170-280
28 cm, 11"

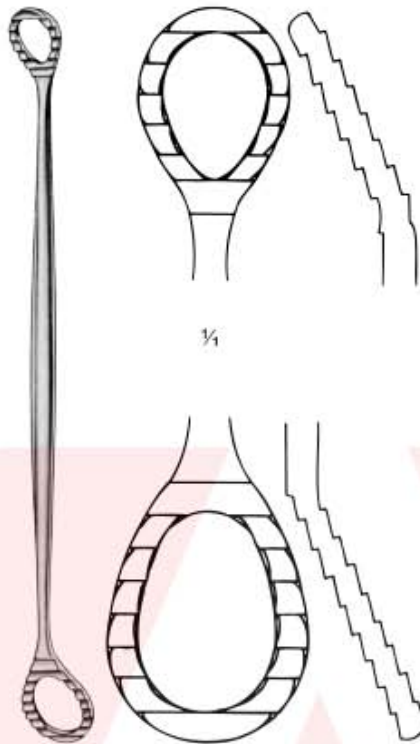

SIMS
LG14-171-260
26 cm, 10 1/4"



KEVORKIAN

1/4
LG14-172-300
30 cm, 12"
1.2mm



LG14-173-300
30 cm, 12"
4.0 mm
Without Basket



LG14-174-300
30 cm, 12"
4.0 mm
With Basket



BLAKE
LG14-175-270
27 cm, 10 3/4"

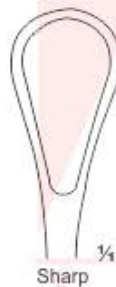

1/4
Sharp



1/4
Blunt



SCHROEDER
30 cm, 12"
sharp, rigid



LG14-176-001



LG14-177-002



LG14-178-003



LG14-179-004



LG14-180-005



LG14-181-006



UTERINE SCOOPS, SUCTION CURETTES & UTERINE DEPRESSOR

Uteruslöffel, Absaugküretten, uterusdepressor

Cucharillas uterinas, Curetas aspiradoras, depresor uterino

Curettes uterines, curettes d'aspiration, Dépresseur utérin

Curette uterine, curette pe aspirazione, depressore uterino



**SIMON/
SCHRODER**



Fig. 1
LG14-182-250 25 cm, 10"
LG14-183-300 30 cm, 12"



Fig. 2
LG14-184-250 25 cm, 10"
LG14-185-300 30 cm, 12"

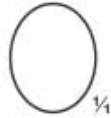

Fig. 3
LG14-186-250 25 cm, 10"
LG14-187-300 30 cm, 12"

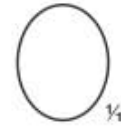

Fig. 4
LG14-188-250 25 cm, 10"
LG14-189-300 30 cm, 12"



Fig. 5
LG14-190-250 25 cm, 10"
LG14-191-300 30 cm, 12"

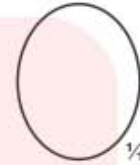

Fig. 6
LG14-192-250 25 cm, 10"
LG14-193-300 30 cm, 12"



COLLIN
28 cm, 11"



LG14-194-280
8.0 mm



LG14-195-280
10.0 mm



LG14-196-280
12.0 mm



LG14-197-280
14.0 mm



GOURDET
28 cm, 11"



Fig. 1
LG14-198-280



Fig. 2
LG14-199-280



Fig. 3
LG14-200-280



Fig. 4
LG14-201-280



Fig. 5
LG14-202-280



UTERINE CURETTES

Uterusküretten
Curetas uterinas

Curettes utérines
curette uterine



Straight Curved
Recamier
Uterine Curette
LG14-203-260 26 cm, 10 1/4"
LG14-203-310 31 cm, 12 1/2"
Sharp/Blunt
All Size Available in
Straight & Curved

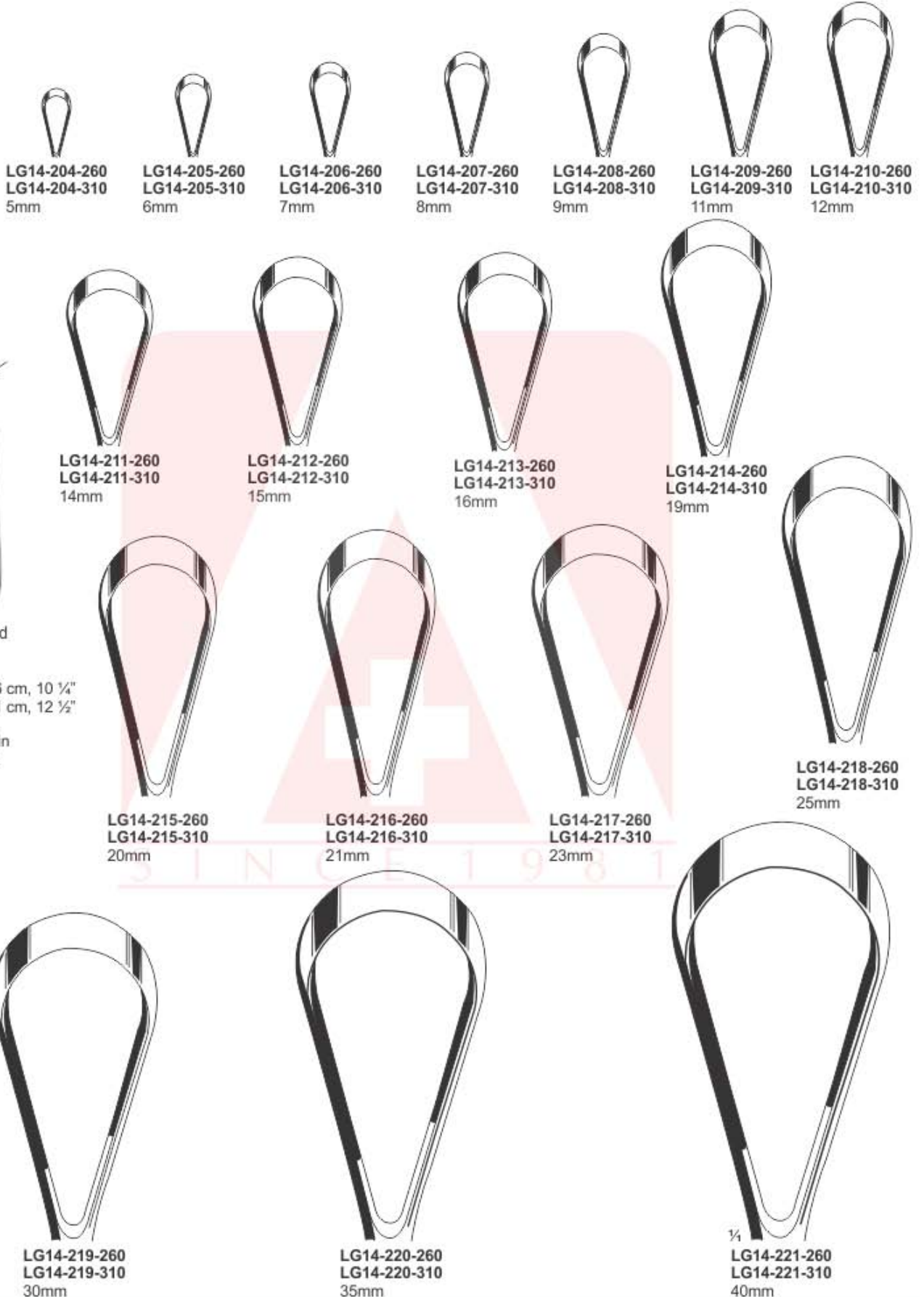



UTERINE CURETTES

Uterusküretten
Curetas uterinas

Curettes utérines
curette uterine



Sims
Uterine Curette
LG14-222-260 26 cm, 10 1/4"
LG14-222-310 31 cm, 12 1/2"
Sharp/Blunt
All Size Available in
Straight & Curved

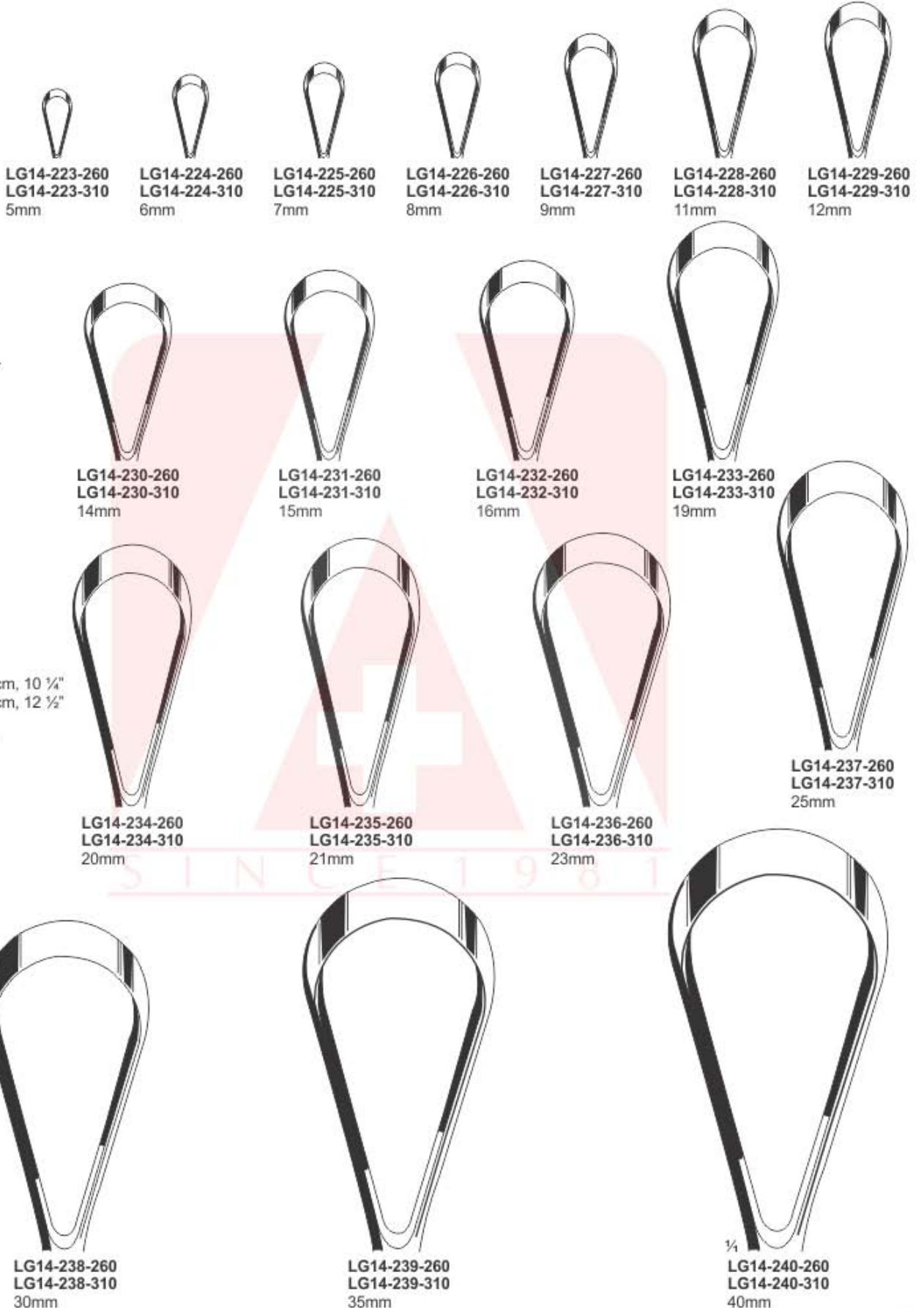

LG14-223-260
LG14-223-310
5mm

LG14-224-260
LG14-224-310
6mm

LG14-225-260
LG14-225-310
7mm

LG14-226-260
LG14-226-310
8mm

LG14-227-260
LG14-227-310
9mm

LG14-228-260
LG14-228-310
11mm

LG14-229-260
LG14-229-310
12mm

LG14-230-260
LG14-230-310
14mm

LG14-231-260
LG14-231-310
15mm

LG14-232-260
LG14-232-310
16mm

LG14-233-260
LG14-233-310
19mm

LG14-234-260
LG14-234-310
20mm

LG14-235-260
LG14-235-310
21mm

LG14-236-260
LG14-236-310
23mm

LG14-237-260
LG14-237-310
25mm

LG14-238-260
LG14-238-310
30mm

LG14-239-260
LG14-239-310
35mm

1/4
LG14-240-260
LG14-240-310
40mm



UTERINE SOUNDS

Uterussonden
Histerómetros

Hystéromètres
Isterometri



malleable

SIMS
LG14-241-320
32 cm, 13"
right
malleable

SIMS-SPECIAL
LG14-242-320
32 cm, 13"

SIMS
schwed. Modell
LG14-243-260
26 cm, 10 1/4"

MARTIN
LG14-244-300
30 cm, 12"

VALLEIX
LG14-245-250
25 cm, 10"

MAYO
LG14-246-330
biegsam malleable
33 cm

SIMPSON
LG14-247-290
malleable
silver-plated
29 cm



UTERINE SOUNDS

Uterussonden
Histerómetros

Hystéromètres
Isterometri

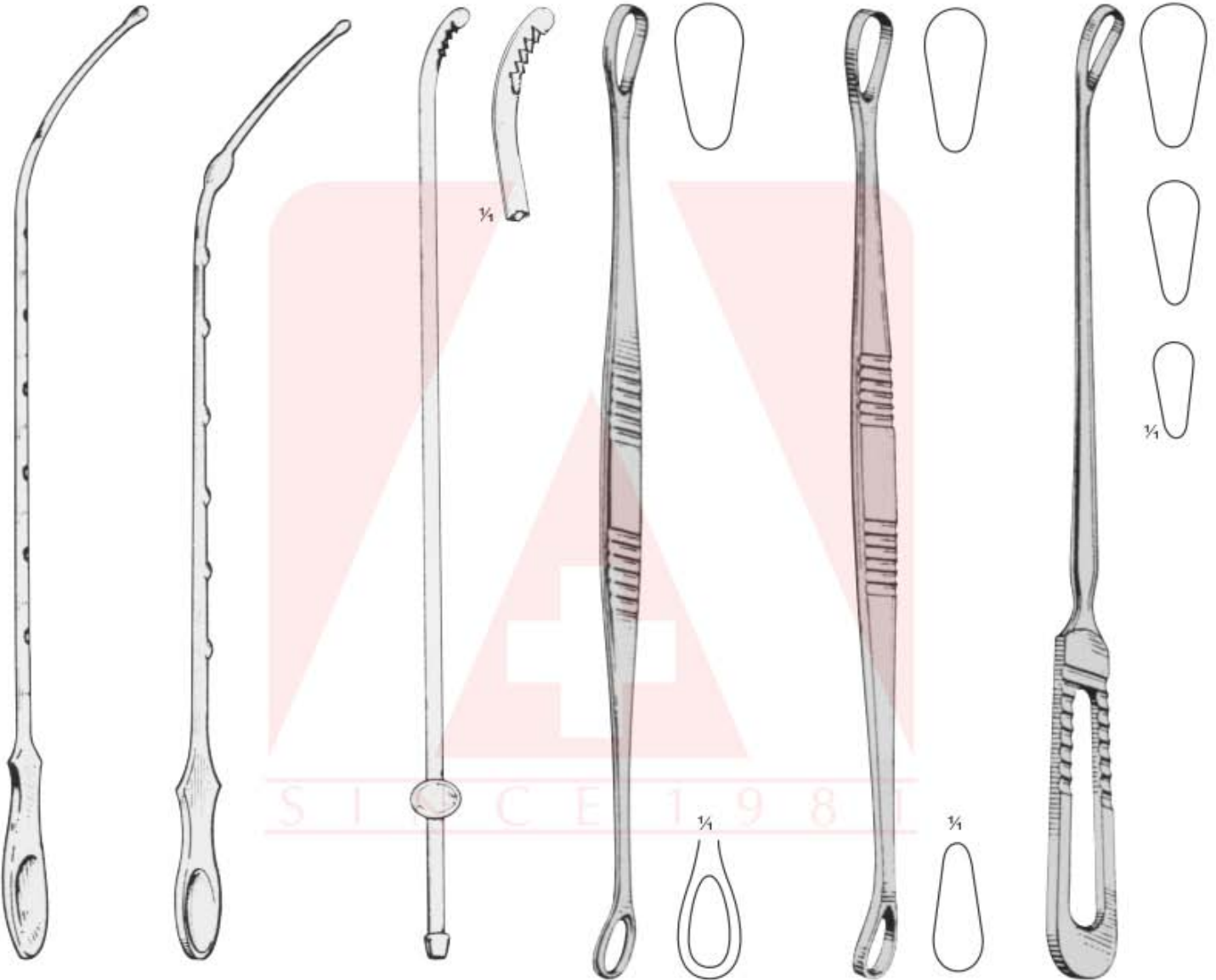

GALABIN
LG14-248-320
malleable, shaft
graduated in cm
Silver plated,
32 cm, 12 1/4"

**HORROCKS
UTERINE
SOUND**
LG14-249-320
malleable, shaft
graduated in cm
Silver plated,
32 cm, 12 1/4"

**NOVAK "SUCTION
CANNULA
CURETTE"**
LG14-250-254
Luer cone,
25.4 cm, 10"

**SIMS UTERINE
CURETTE**
LG14-251-250
double ended, sharp
as above but blunt
25 cm, 10"
small, medium, large

**SIMS UTERINE
CURETTE.**
LG14-252-250
double ended, sharp
25 cm, 10"
long.

**SIMS UTERINE
CURETTE**
LG14-253-250
single ended, sharp
and blunt ends.
25 cm, 10"
long.



UTERINE DILATORS

Uterusdilatatoren
Dilatadores uterinos

Dilatateurs du col de l'utérus
Dilatatori uterini



PRATT GYNE



PRATT GYNE
LG14-254-001
Set of 8 Double ended
size 13/14 thru 41/43
4.5/5.0mm thru 13.6/14.3mm

LG14-255-001	04.5/05.0 mm
LG14-256-002	05.6/06.3 mm
LG14-257-003	07.0/07.6 mm
LG14-258-004	08.3/09.0 mm
LG14-259-005	09.6/10.3 mm
LG14-260-006	11.0/11.6 mm
LG14-261-007	12.3/13.0 mm
LG14-262-008	13.6/14.3 mm



HEGAR
LG14-263-001
Set of 8 dilator
3/4 mm - 17/18 mm
LG14-264-002
Set of 13 dilator
1/2 mm - 25/26 mm



HANK

LG14-265-001	4.5/5 mm
LG14-266-002	5.5/6 mm
LG14-267-003	6.5/7 mm
LG14-268-004	7.5/8 mm
LG14-269-005	8.5/9 mm
LG14-270-006	9.5/10 mm

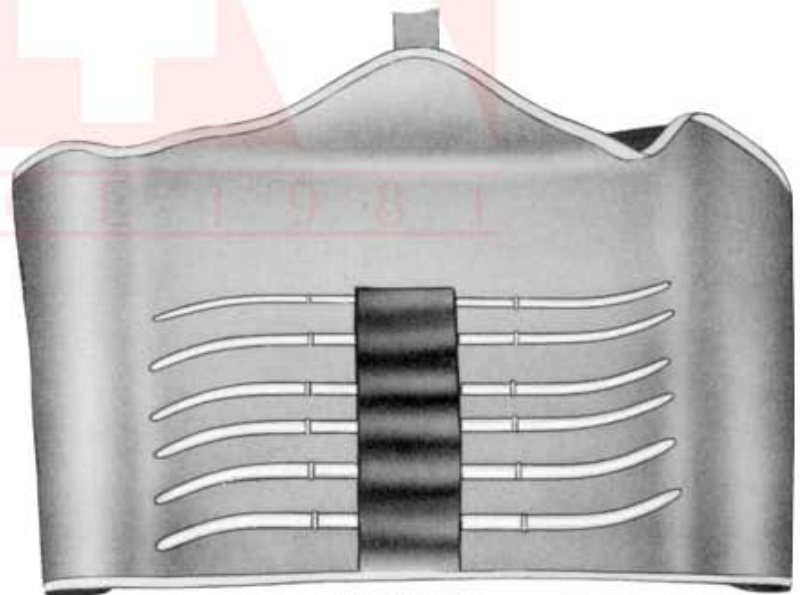

HANK GYNE
LG14-271-001
Set of 6 dilators
4.5/5.0 mm - 9.5/10.0 mm



UTERINE DILATORS

Uterusdilatatoren
Dilatadores uterinos

Dilateurs du col de l'utérus
Dilatatori uterini



LG14-272-001
Set of 13 dilators
1/2 mm - 25/26 mm
LG14-273-002
Set of 8 dilators
3/4 mm - 17/18 mm

HEGAR GYNE

LG14-272-001	01/02 mm
LG14-273-002	03/04 mm
LG14-274-003	05/06 mm
LG14-275-004	07/08 mm
LG14-276-005	09/10 mm
LG14-277-006	11/12 mm
LG14-278-007	13/14 mm
LG14-279-008	15/16 mm
LG14-280-009	17/18 mm
LG14-281-010	19/20 mm
LG14-282-011	21/22 mm
LG14-283-012	23/24 mm
LG14-284-013	25/26 mm



HEGAR GYNE

LG14-285-001
Set of 8 dilators
3/4 mm - 17/18 mm



LG14-286-001	1 mm
LG14-287-002	2 mm
LG14-288-003	3 mm
LG14-289-004	4 mm
LG14-290-005	5 mm
LG14-291-006	6 mm
LG14-292-007	7 mm
LG14-293-008	8 mm
LG14-294-009	9 mm
LG14-295-010	10 mm
LG14-296-011	11 mm
LG14-297-012	12 mm
LG14-298-013	13 mm
LG14-299-014	14 mm
LG14-300-015	15 mm
LG14-301-016	16 mm
LG14-302-017	17 mm
LG14-303-018	18 mm
LG14-304-019	19 mm
LG14-305-020	20 mm
LG14-306-021	21 mm
LG14-307-022	22 mm
LG14-308-023	23 mm
LG14-309-024	24 mm
LG14-310-025	25 mm
LG14-311-026	26 mm

LG14-316-001
Set of 14 dilators
4 mm - 17 mm

LG14-317-001	1.5 mm
LG14-318-002	2.5 mm
LG14-319-003	3.5 mm
LG14-320-004	4.5 mm
LG14-321-005	5.5 mm
LG14-322-006	6.5 mm
LG14-323-007	7.5 mm
LG14-324-008	8.5 mm
LG14-325-009	9.5 mm
LG14-326-010	10.5 mm
LG14-327-011	11.5 mm
LG14-328-012	12.5 mm
LG14-329-013	13.5 mm
LG14-330-014	14.5 mm
LG14-331-015	15.5 mm
LG14-332-016	16.5 mm
LG14-333-017	17.5 mm
LG14-334-018	18.5 mm
LG14-335-019	19.5 mm



HEGAR GYNE

LG14-336-001
Set of 14 dilators
4 mm - 17 mm

HEGAR GYNE

LG14-286-001
Set of 26 dilators
1 mm - 26 mm



UTERINE BIOPSY FORCEPS

Probeexzisionszangen
Pinzas para biopsia

Pinces pour biopsi
Pinze per biopsia



TISCHLER-KEVORKIAN
LG14-337-220
22 cm, 8 3/4"
with latch
3 x 9.5 mm

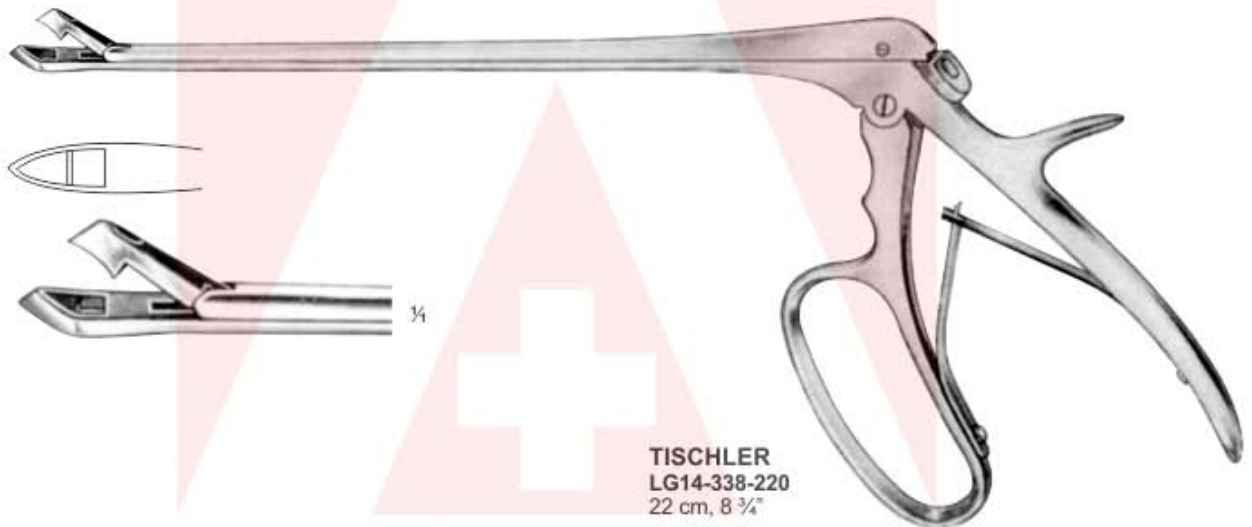

TISCHLER
LG14-338-220
22 cm, 8 3/4"

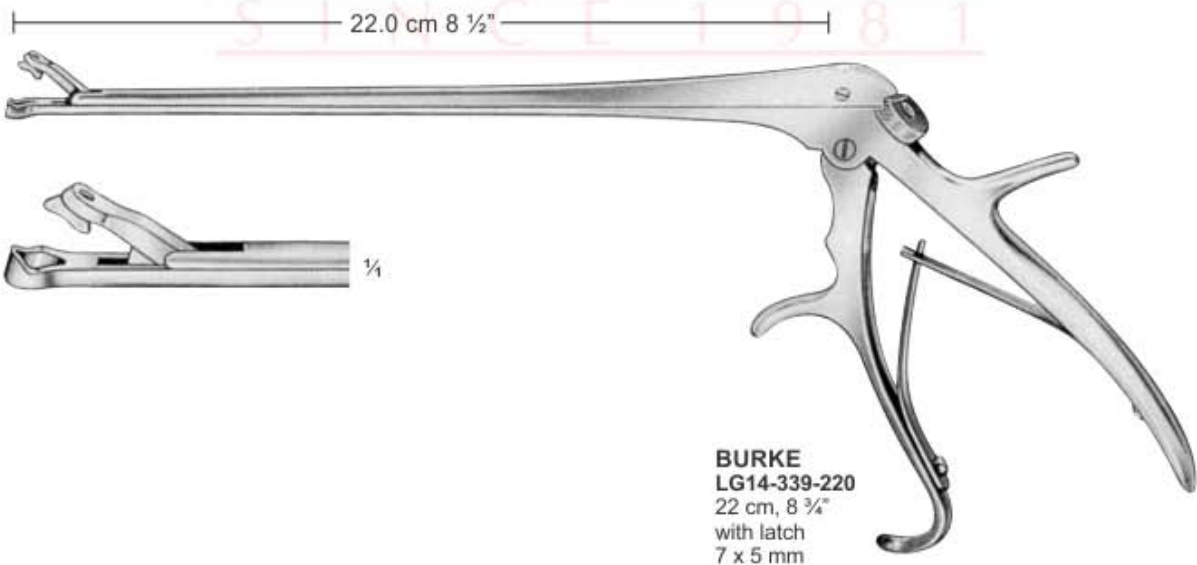

BURKE
LG14-339-220
22 cm, 8 3/4"
with latch
7 x 5 mm



UTERINE BIOPSY FORCEPS

Probeexzisionszangen
Pinzas para biopsia

Pinces pour biopsi
Pinze per biopsia

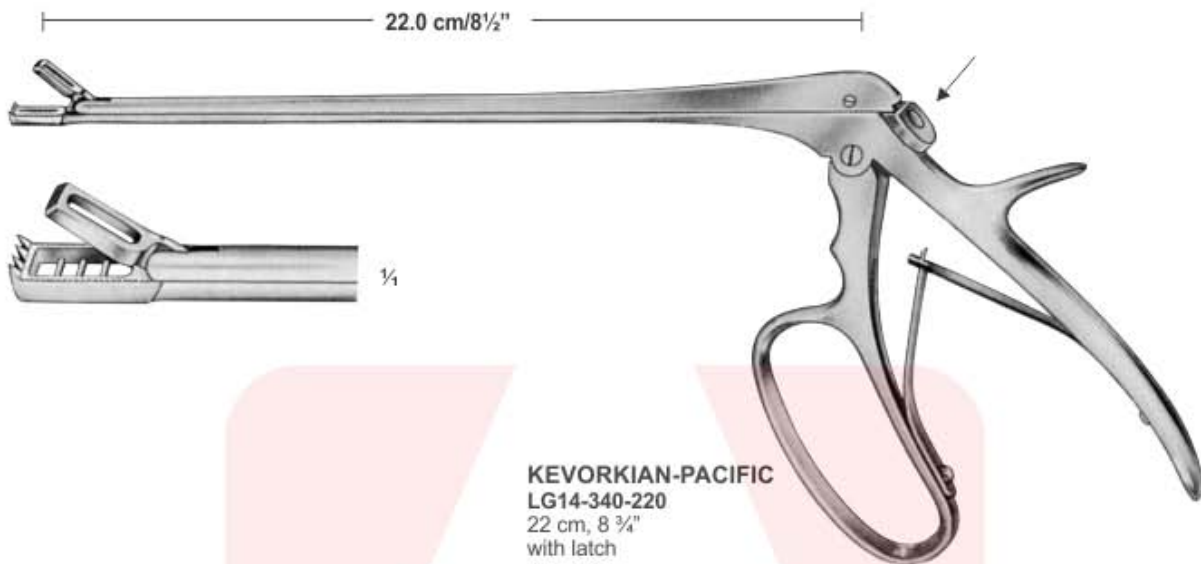

KEVORKIAN-PACIFIC
LG14-340-220
22 cm, 8 3/4"
with latch
3 x 8 mm



ALEXANDER
LG14-341-200
20 cm, 8"

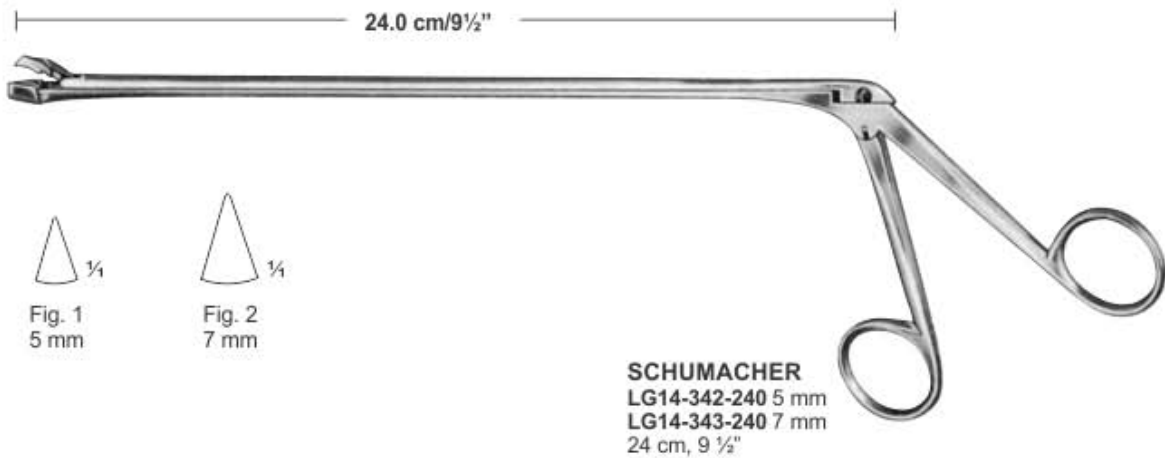

Fig. 1
5 mm



Fig. 2
7 mm

SCHUMACHER
LG14-342-240 5 mm
LG14-343-240 7 mm
24 cm, 9 1/2"



UTERINE BIOPSY FORCEPS

Probeexzisionszangen
Pinzas para biopsia

Pinces pour biopsi
Pinze per biopsia

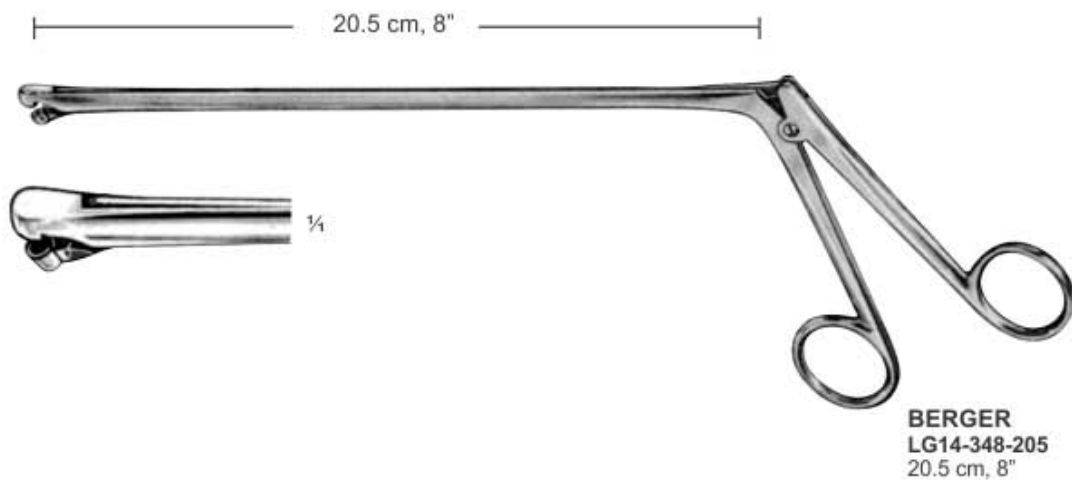
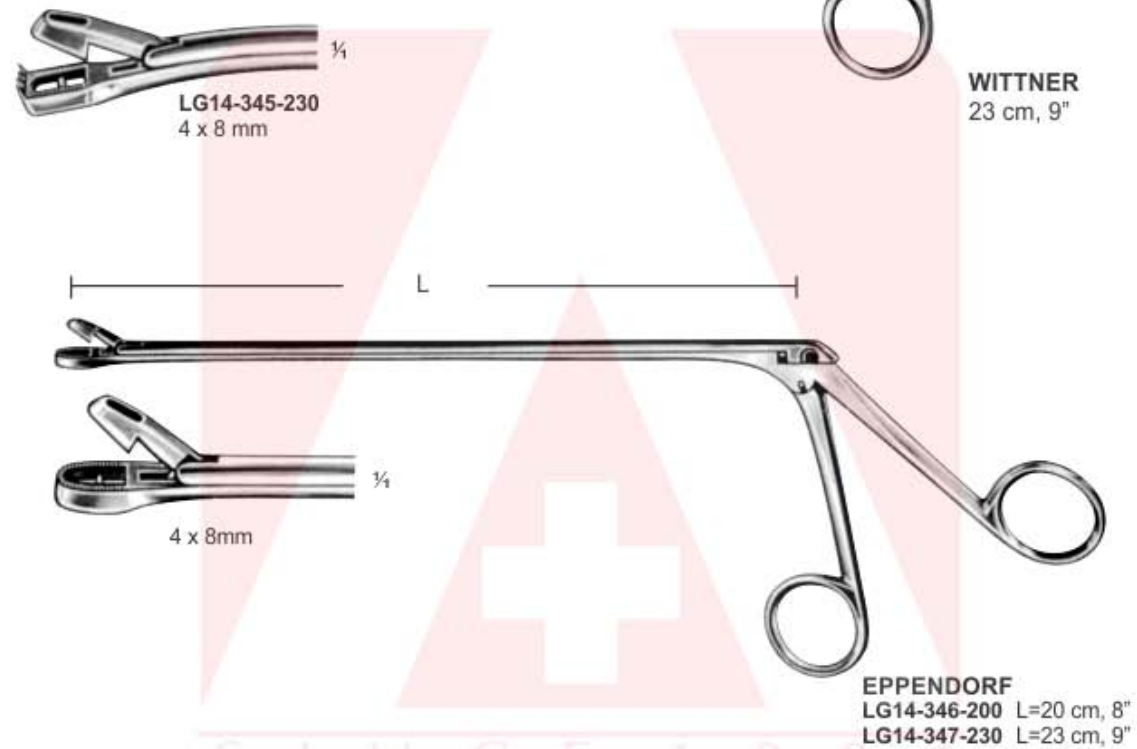
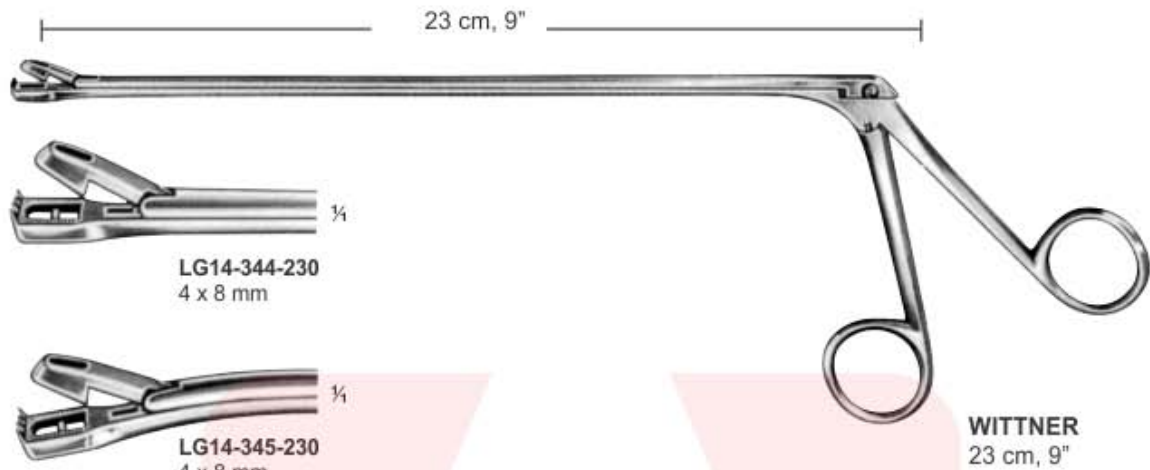



UTERINE BIOPSY FORCEPS

Probeexzisionszangen
Pinzas para biopsia

Pinces pour biopsi
Pinze per biopsia

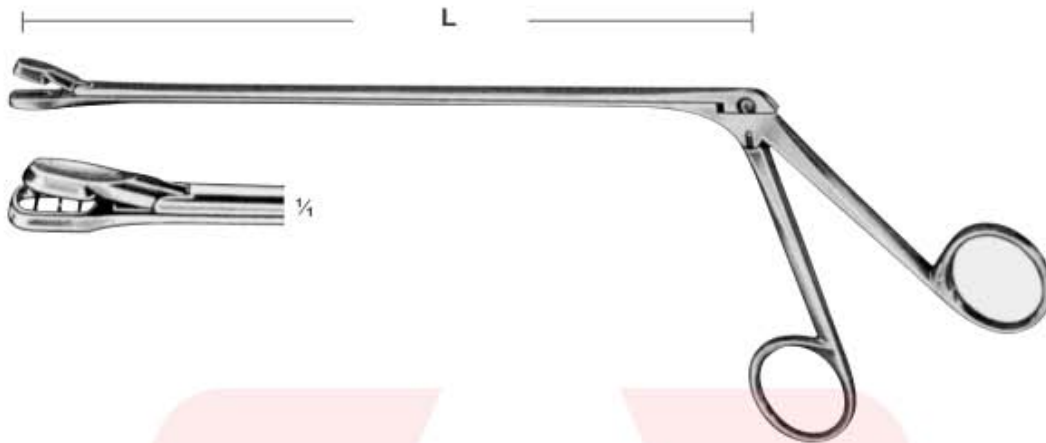

DOUAY

LG14-349-200 L=20 cm, 8"
LG14-350-250 L=25 cm, 10"
LG14-351-300 L=30 cm, 12"
LG14-352-350 L=35 cm, 14"
LG14-353-400 L=40 cm, 16"

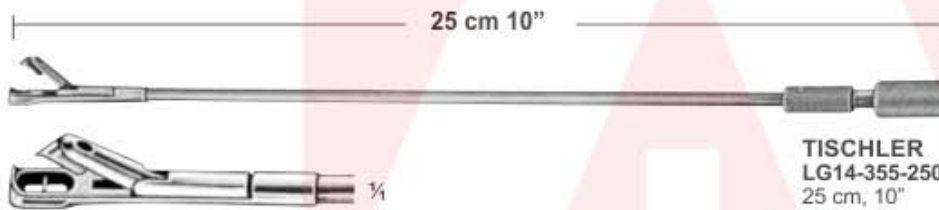

TISCHLER
LG14-355-250
25 cm, 10"



KEVORKIAN
LG14-356-250
25 cm, 10"

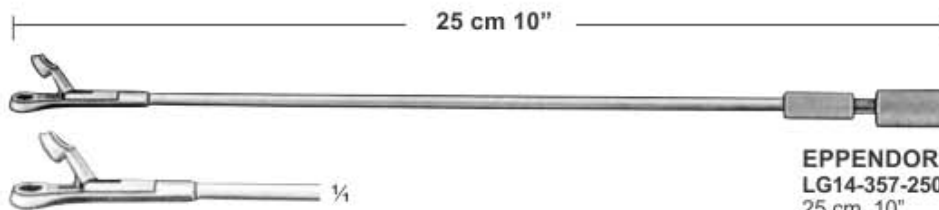

EPENDORF
LG14-357-250
25 cm, 10"

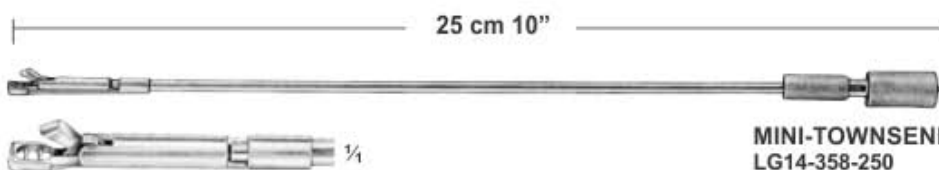

MINI-TOWNSEND
LG14-358-250
25 cm, 10"



LG14-354-001



UTERINE BIOPSY FORCEPS

Probeexzisionszangen

Pinzas para biopsia

Pinces pour biopsi

Pinze per biopsia



LG14-359-200
20 cm, 8"
With Fixing Screw
2.3 x 4.2 mm
LG14-360-200
20 cm, 8"
Without Fixing Screw
2.3 x 4.2 mm

TISCHLER

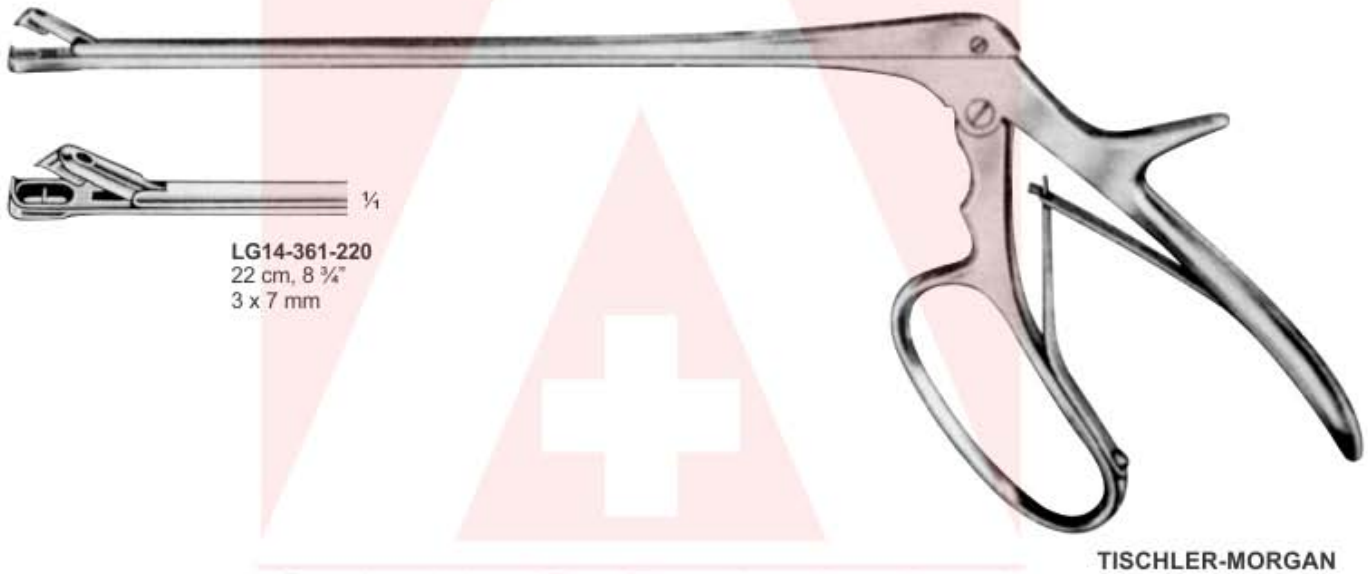

LG14-361-220
22 cm, 8 3/4"
3 x 7 mm

TISCHLER-MORGAN



LG14-362-230
23 cm, 9"
3 x 9.7 mm
LG14-363-250
25 cm, 10"
3 x 9.7 mm

KEVORKIAN

S I N C E 1 9 8 1



UTERINE BIOPSY FORCEPS

Probeexzisionszangen
Pinzas para biopsia

Pinces pour biopsi
Pinze per biopsia



GELLHORN
LG14-364-230
23 cm, 9"



FAURE
LG14-365-230
23 cm, 9"



SCHUBERT
LG14-366-210 21 cm, 8 1/4"
LG14-367-280 28 cm, 11"



THOMS-GAYLOR
LG14-368-240
24 cm, 9 1/2"



SCHUBERT
LG14-369-260
26 cm, 10 1/4"



TISCHLER
LG14-370-270
27 cm, 10 1/2"

S I N C E 1 9 8 1



UTERINE BIOPSY FORCEPS

Probeexzisionszangen
Pinzas para biopsia

Pinces pour biopsi
Pinze per biopsia



Fig. 1
5 mm

Fig. 2
7 mm

SCHUMACHER-NAN-DOREN
LG14-371-240 Fig. 1
LG14-372-240 Fig. 2
24 cm, 9 1/2"



VAN DOREN
LG14-373-250
25 cm, 10"



VAN DOREN
LG14-374-250
25 cm, 10"



NAEGELE
LG14-375-250
25 cm, 10"



SMELLIE
LG14-376-250
25 cm, 10"



BRAUN
LG14-377-300
30 cm, 12"



SMELLIE
LG14-378-300
30 cm, 12"

S I N C E 1 9 8 1



PLACENTA & OVUM FORCEPS

Abortuszangen
Pinzas para aborto

Pinces placentaires et pour poste-abortum
Pinze per placenta e per ovaie



WINTER

LG14-379-280 Fig. 1
LG14-380-280 Fig. 2
LG14-381-280 Fig. 3
28 cm, 11"

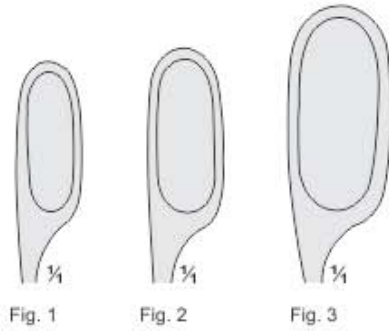

WINTER

LG14-382-280 Fig. 1
LG14-383-280 Fig. 2
LG14-384-280 Fig. 3
28 cm, 11"



SAENGER
27 cm, 10 1/2"

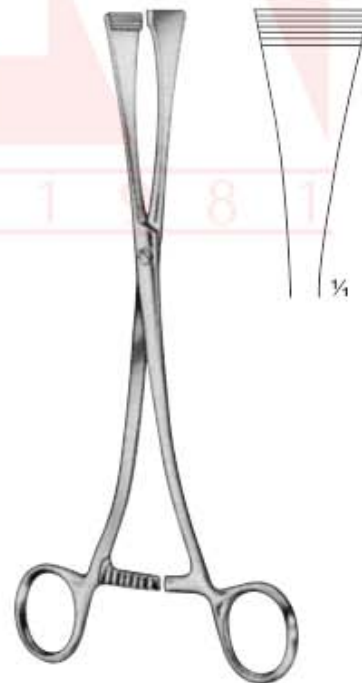
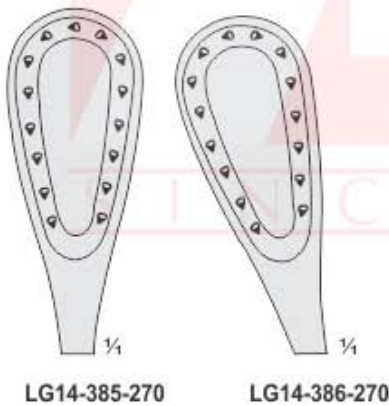

GREEN-ARMYTAGE
LG14-387-210
21 cm, 8 1/4"



WALLICH
LG14-388-420
42 cm, 16 1/2"



OBSTETRICAL FORCEPS

Geburtszangen
Forceps obstétricos

Forceps obstétriques
Forcipi obstetrici

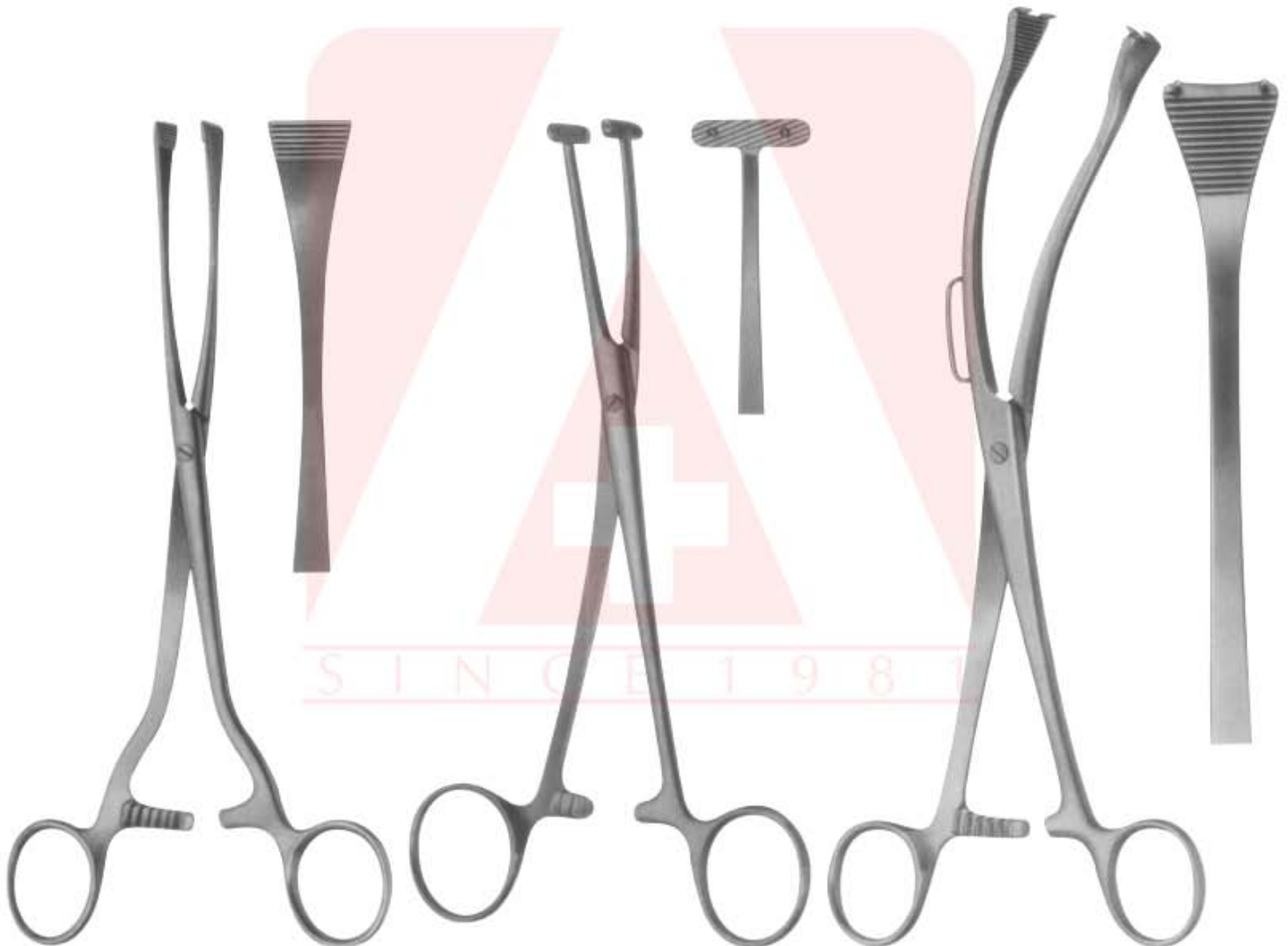

GREEN-ARMYTAGE LG14-389-220

caesarean section haemostatic
forceps, for edges of the transverse
incision in the lower segment
22 cm, 8 $\frac{3}{4}$ "

WILLETT LG14-390-185

Scalpel Flap Forceps
18.5 cm, 7 $\frac{1}{4}$ "

GAUSS LG14-391-260

Scalpel Flap Forceps
26 cm, 10 $\frac{1}{4}$ "



PELVIMETER, OBSTETRICAL FORCEPS

Beckenzirkel, Geburtszangen
Pelvímetro, Forceps obstétricos

Pelvimètre, Forceps obstétriques
Pelvimetri, Forcipi obstetrici

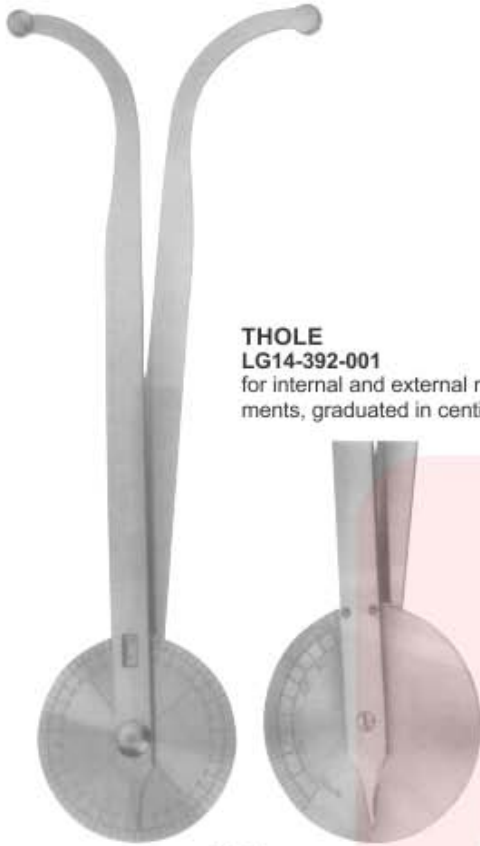

THOLE
LG14-392-001
for internal and external measurements, graduated in centimeters

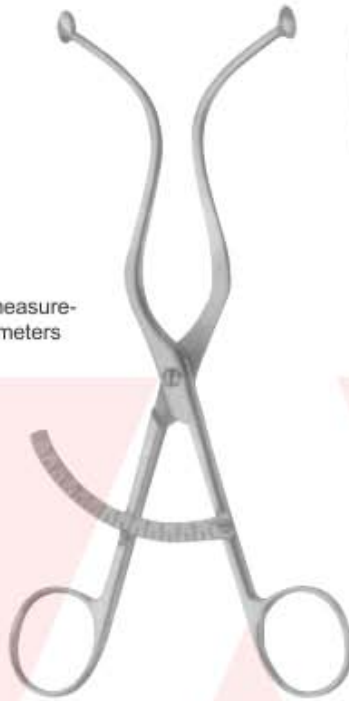

DE LEE
LG14-393-001
graduated in centimeters and inches

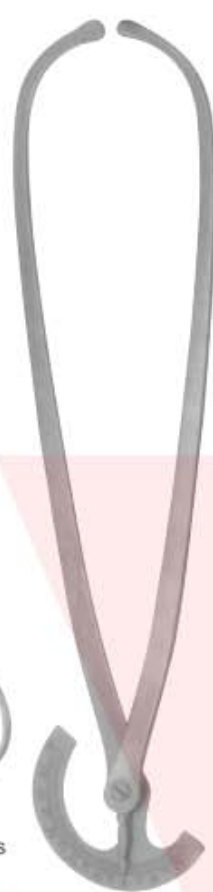

COLLIN
LG14-394-001
graduated in centimeters



MARTIN
LG14-395-001
graduated in centimeters



for internal measurements between symphysis and promontory



COLLIN
LG14-396-001
graduated in centimeters

The additional straight arm can be replaced. The pelvimeter with straight arm is used for localisation of the portio vaginalis uteri and of vaginal metastasis.



BREISKY
LG14-397-001
graduated in centimeters

S I N C E 1 8 8 1



OBSTETRICAL FORCEPS

Geburtszangen
Forceps obstétricos

Forceps obstétriques
Forcipi obstetrici



PIPER
LG14-398-440
44 cm, 18"



NAEGELE
LG14-399-360 36 cm, 14 1/4"
LG14-400-400 40 cm, 15 3/4"



SIMPSON
LG14-401-300
30 cm, 12"



SIMPSON-BRAUN
LG14-402-330 33 cm, 13 1/2"
LG14-403-380 38 cm, 14 1/2"



MCLEAN
LG14-404-360
36 cm, 14 1/4"



KIELLAND
LG14-405-410
41 cm, 16"





OBSTETRICAL FORCEPS

Geburtszangen
Forceps obstétricos

Forceps obstétriques
Forcipi obstetrici



KIELLAND-LUIKART
LG14-406-410
41 cm, 16"



WRIGLEY
LG14-407-230
23 cm, 9"



DE LEE
LG14-408-300
30 cm, 12"

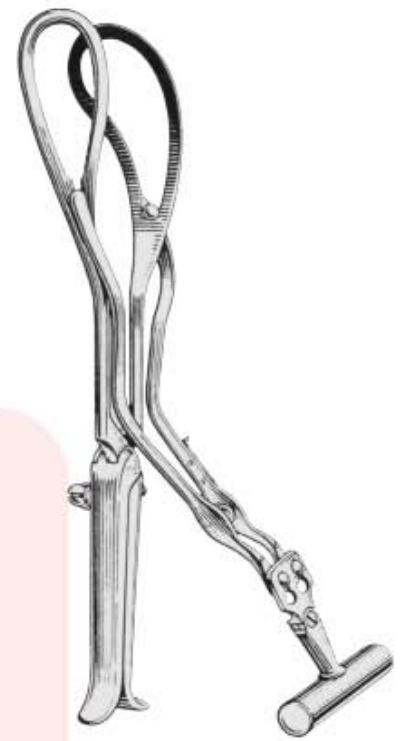

MILNE MURRAY
LG14-409-001
detach-able axis traction
rod & handle.

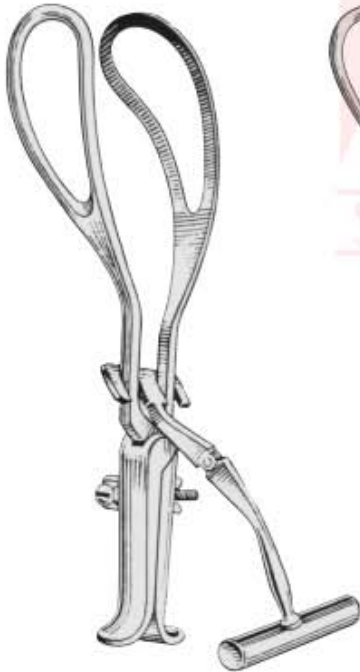

HAIG FERGUSON
LG14-410-001
detachable axis traction
rod & handle.



BARNES-NEVILLE
LG14-411-001
Simpson handles, detachable
axis traction rod and handle.



BRAUN
LG14-412-420
42 cm, 16 1/4"

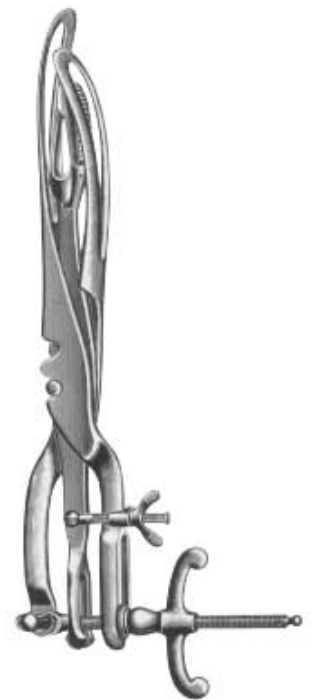

TARNIER
LG14-413-440
44 cm, 17 1/4"