

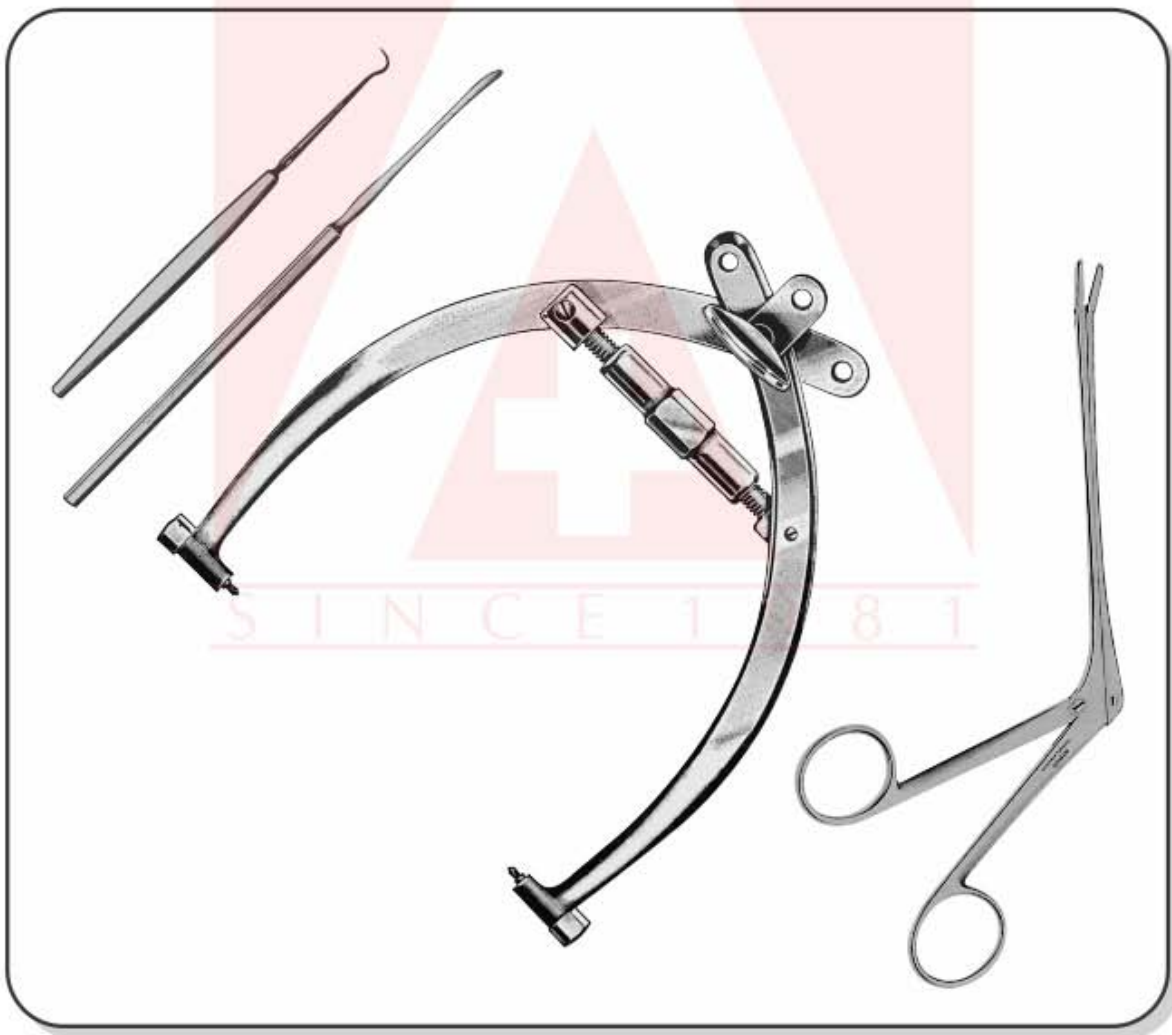

# NEUROSURGERY





## RHOTON-MERZ BRAIN RETRACTOR SET

RHOTON-MERZ-Reraktorensatz

Jeu d'écarteurs du cerveau de RHOTON-MERZ

Set di divaricatori cerebrali RHOTON-MERZ

Juego de retractores cerebrales RHOTON-MERZ



**LG11-001-001**  
wire cable only

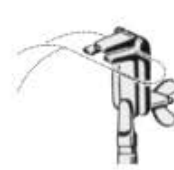

**LG11-002-002**  
Support only,  
flat brain spatulas,



**LG11-003-003**  
Support only,  
for brain spatulas  
with round shaft  
up to 5.5 mm diam.  
Fixing for flexible

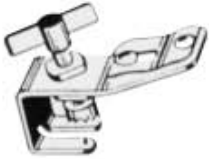

**LG11-004-004**  
**RIECHERT**  
Fixation base, for skull  
mounting, holding 1  
flexible arms



**LG11-005-005**  
**RIECHERT**  
Fixation base, for skull  
mounting, holding 2  
flexible arms



**LG11-006-006**  
Fixation base, for skull  
mounting, holding 1  
flexible arms

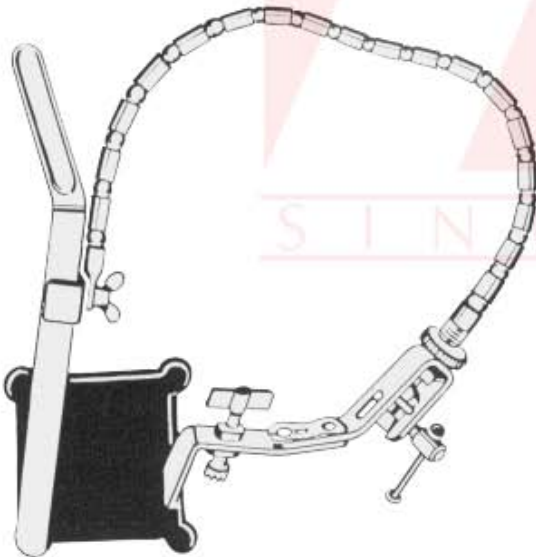

**LEYLA**  
Self-Retaining Brain Retractor  
with 1 flexible arm, complete consisting of  
**LG11-007-001**  
**LG11-008-002**  
**LG11-009-003**



**LEYLA**  
Self-Retaining Brain Retractor  
with 2 flexible arms, complete consisting of  
**LG11-010-001**  
**LG11-011-002**  
**LG11-012-003**



## Hand drill, TWIST DRILLS, SPHERICAL BURRS

Handbohrapparate, Spiralbohrer, Kugelfräser

Perforadores de mano, Brocas espirales, Taladros esféricos

Perforateurs à main, Meches hélicoïdales, Fraises sphériques

Perforatori a mano, Punte a spirale, Frese sferiche

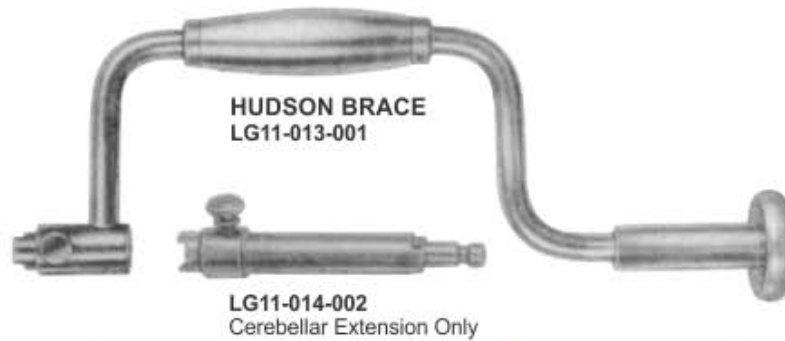

HUDSON BRACE  
LG11-013-001

LG11-014-002  
Cerebellar Extension Only



HUDSON  
LG11-015-003  
Ø 9 mm



HUDSON  
LG11-016-004  
Ø 14 mm



HUDSON  
LG11-017-005  
Ø 16 mm



HUDSON  
LG11-018-006  
Ø 22 mm



ADSON  
LG11-019-007  
Ø 15 mm



Mc KENZIE  
LG11-020-008  
Ø 13 mm



CUSHING  
LG11-021-009  
Ø 14 mm



LG11-022-010  
Ø 2 mm



GALT

LG11-023-001 Ø 12,5 mm  
LG11-024-002 Ø 16 mm  
LG11-025-003 Ø 19 mm



# RONGEURS

Laminektomieztangen

Pinzas Para Laminectomía

Pinces Pour Laminectomie

Pinze Per Laminectomia

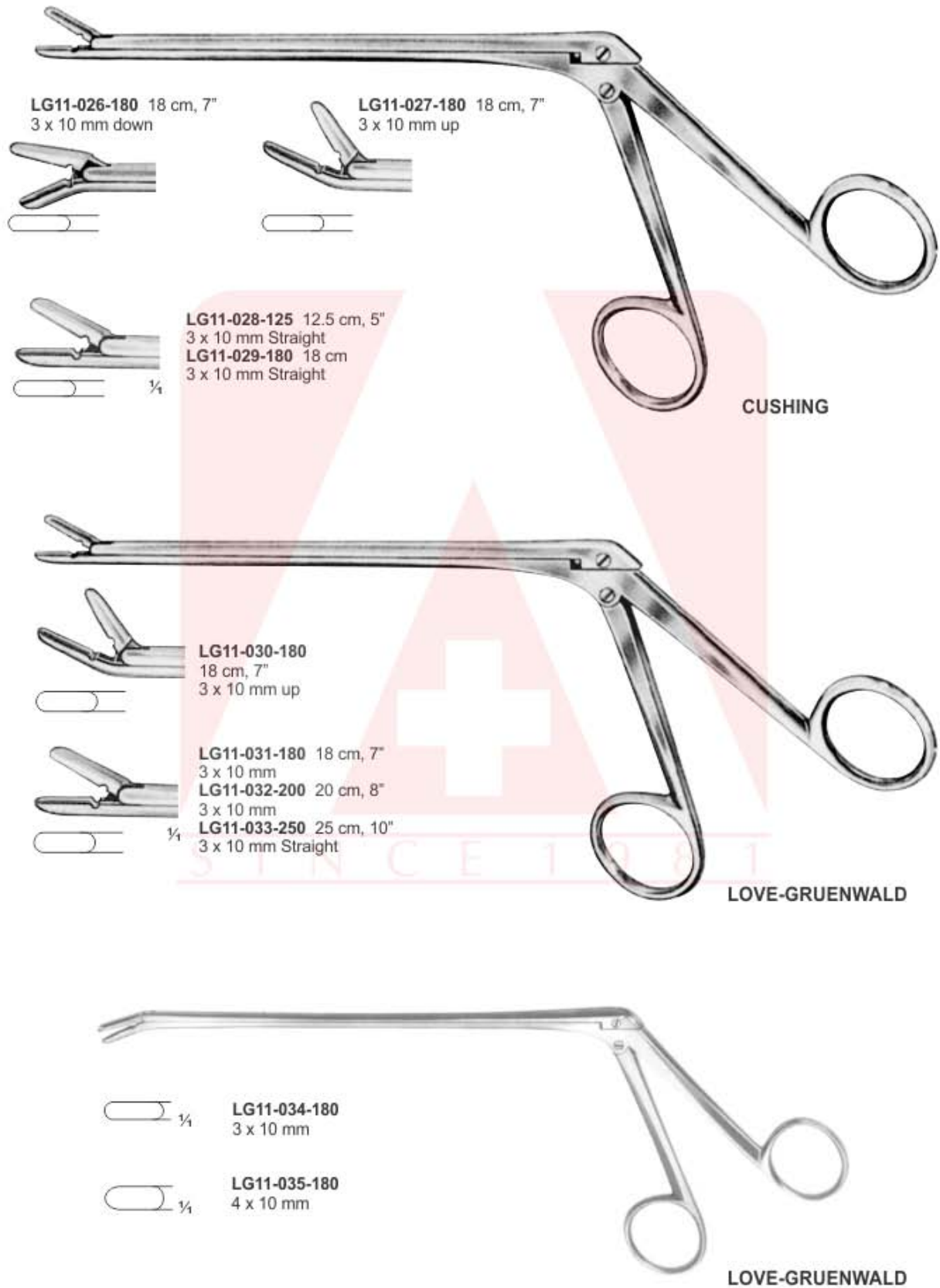



# RONGEURS

Laminektomieztangen

Pinzas Para Laminectomía

Pinces Pour Laminectomie

Pinze Per Laminectomia

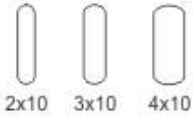

Straight Shaft	120 mm	150 mm	180 mm
Bite 2 x 10 mm	LG11-035-001	LG11-038-001	LG11-041-001
Bite 3 x 10 mm	LG11-036-002	LG11-039-002	LG11-042-002
Bite 4 x 10 mm	LG11-037-003	LG11-040-003	LG11-043-003



Angled - up Shaft	120 mm	150 mm	180 mm
Bite 2 x 10 mm	LG11-044-001	LG11-047-001	LG11-050-001
Bite 3 x 10 mm	LG11-045-002	LG11-048-002	LG11-051-002
Bite 4 x 10 mm	LG11-046-003	LG11-049-003	LG11-052-003



Angled - down Shaft	120 mm	150 mm	180 mm
Bite 2 x 10 mm	LG11-053-001	LG11-056-001	LG11-059-001
Bite 3 x 10 mm	LG11-054-002	LG11-057-002	LG11-060-002
Bite 4 x 10 mm	LG11-055-003	LG11-058-003	LG11-061-003



**CUSHING  
LOVE - GRUENWALD  
SPURLING**



**LG11-062-001**  
Straight



**LG11-063-002**  
Angled-up



**LG11-064-003**  
Angled-down



Shaft 150 mm  
Bite 6 x 10 mm



**CLOWARD-TYPE**  
Serrated cup jaws





# LAMINECTOMY RONGEURS

Laminektomieztangen



Pinzas Para Laminectomía

Pinces Pour Laminectomie

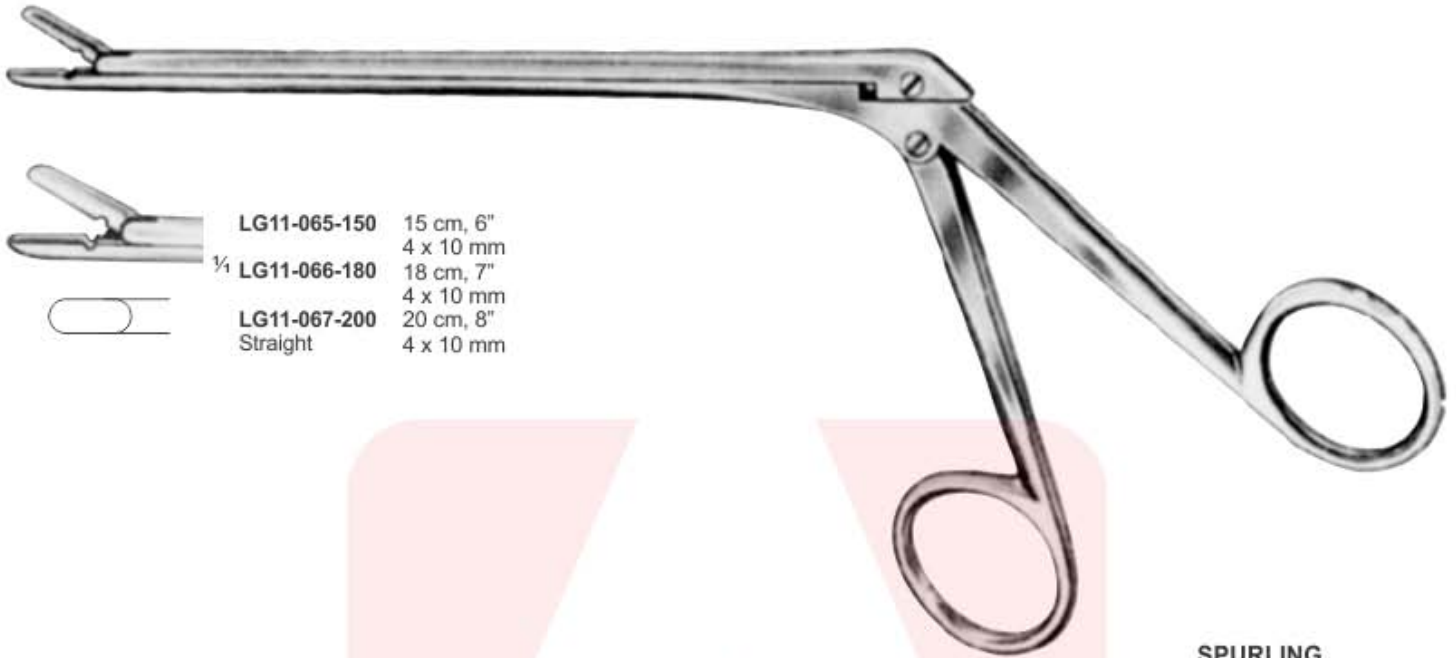
Pinze Per Laminectomia



SPURLING

	<b>LG11-065-150</b>	15 cm, 6" 4 x 10 mm
$\frac{1}{4}$ 	<b>LG11-066-180</b>	18 cm, 7" 4 x 10 mm
	<b>LG11-067-200</b>	20 cm, 8" 4 x 10 mm
	Straight	



SCHLESINGER

			$\frac{1}{4}$
<b>LG11-068-150</b>	<b>LG11-069-150</b>	<b>LG11-070-150</b>	
15 cm, 6"	15 cm, 6"	15 cm, 6"	
Straight	Straight	Straight	
2 x 10 mm	3 x 10 mm	4 x 10 mm	
Serrated	Serrated	Serrated	



SCHLESINGER

Shaft	120 mm	180 mm
Bite 2 x 10 mm	<b>LG11-071-001</b>	<b>LG11-074-001</b>
Bite 3 x 10 mm	<b>LG11-072-002</b>	<b>LG11-075-002</b>
Bite 4 x 10 mm	<b>LG11-073-003</b>	<b>LG11-076-003</b>

Straight



# LAMINECTOMY PUNCHES

Laminektomiestanzen

Pinzas Cortantes Para Laminectomía

Pinces Emporte-pièces à Laminectomie

Pinze Taglienti Per Laminectomia

2.0 mm 3.0 mm 3.5 mm



90°  
Up-cutting  
Shaft 140 mm  
Bite 2.0 mm **LG11-077-001**  
Bite 3.0 mm **LG11-078-002**  
Bite 3.5 mm **LG11-079-003**



90°  
Down-cutting  
Shaft 140 mm  
Bite 2.0 mm **LG11-080-001**  
Bite 3.0 mm **LG11-081-002**  
Bite 3.5 mm **LG11-082-003**

160 mm, 6 1/4"



**HAJEK-KOFLER**

**HAJEK-KOFLER**  
**LG11-083-001**  
3.5 mm

1.0 mm  
2.5 mm  
4.0 mm

**CITELLI**  
**LG11-084-001** 1.0 mm  
**LG11-085-002** 2.5 mm  
**LG11-086-003** 4.0 mm





# PUNCHES

Laminectomiestanzen

Pinzas Cortantes Para Laminectomía

Pinces Emporte-pièces à Laminectomie

Pinze Taglienti Per Laminectomia



LOVE-KERRISON  
LAMINECTOMY PUNCH



Forward 90° Regular Footplate

- 2 mm bite forward  
**LG11-087-001** 150 mm  
**LG11-088-002** 200 mm

- 3 mm bite forward  
**LG11-089-003** 150 mm  
**LG11-090-004** 200 mm

- 4 mm bite forward  
**LG11-091-005** 150 mm  
**LG11-092-006** 200 mm

- 5 mm bite forward  
**LG11-093-007** 150 mm  
**LG11-094-008** 200 mm

- 6 mm bite forward  
**LG11-095-009** 150 mm  
**LG11-096-010** 200 mm



Up 40° Regular footplate

- 2 mm bite up  
**LG11-097-001** 150 mm  
**LG11-098-002** 200 mm

- 3 mm bite up  
**LG11-099-003** 150 mm  
**LG11-100-004** 200 mm

- 4 mm bite up  
**LG11-101-005** 150 mm  
**LG11-102-006** 200 mm

- 5 mm bite up  
**LG11-103-007** 150 mm  
**LG11-104-008** 200 mm

- 6 mm bite up  
**LG11-105-009** 200 mm



Down 90° Regular footplate

- 3 mm bite down  
**LG11-106-001** 150 mm  
**LG11-107-002** 200 mm

- 4 mm bite down  
**LG11-108-003** 150 mm  
**LG11-109-004** 200 mm

- 5 mm bite down  
**LG11-110-005** 150 mm  
**LG11-111-006** 200 mm





# LAMINECTOMY PUNCHES

Laminektomiestanzen

Pinzas Cortantes Para Laminectomía

Pinces Emporte-pièces à Laminectomie

Pinze Taglienti Per Laminectomia



THIN FOOTPLATE  
KERRISON PUNCH



Forward 90° Thin footplate

- 1 mm bite forward  
**LG11-112-001** 150 mm  
**LG11-113-002** 180 mm  
**LG11-114-003** 200 mm

- 2 mm bite forward  
**LG11-115-004** 150 mm  
**LG11-116-005** 180 mm  
**LG11-117-006** 200 mm

- 3 mm bite forward  
**LG11-118-007** 150 mm  
**LG11-119-008** 180 mm  
**LG11-120-009** 200 mm

- 4 mm bite forward  
**LG11-121-010** 150 mm  
**LG11-122-011** 180 mm  
**LG11-123-012** 200 mm

- 5 mm bite forward  
**LG11-124-013** 150 mm  
**LG11-125-014** 180 mm  
**LG11-126-015** 200 mm



Up 40° Thin footplate

- 1 mm bite up  
**LG11-127-001** 180 mm

- 2 mm bite up  
**LG11-128-002** 180 mm

- 3 mm bite up  
**LG11-129-003** 180 mm

- 4 mm bite up  
**LG11-130-004** 180 mm

- 5 mm bite up  
**LG11-131-005** 180 mm



Down 90° Thin footplate

- 1 mm bite down  
**LG11-132-001** 180 mm

- 2 mm bite down  
**LG11-133-002** 180 mm

- 3 mm bite down  
**LG11-134-003** 180 mm

- 4 mm bite down  
**LG11-135-004** 180 mm

- 5 mm bite down  
**LG11-136-005** 180 mm



# LAMINECTOMY RONGEURS

Laminektomieztangen  
Pinzas Para Laminectomía

Pinces Pour Laminectomie  
Pinze Per Laminectomia

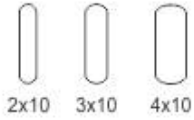

2x10 3x10 4x10



Straight Shaft	180 mm
Bite 2 x 10 mm	<b>LG11-137-001</b>
Bite 3 x 10 mm	<b>LG11-138-002</b>
Bite 4 x 10 mm	<b>LG11-139-003</b>



Angled - up Shaft	180 mm
Bite 2 x 10 mm	<b>LG11-140-004</b>
Bite 3 x 10 mm	<b>LG11-141-005</b>
Bite 4 x 10 mm	<b>LG11-142-006</b>

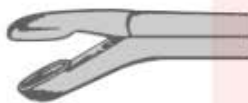

Angled - down Shaft	180 mm
Bite 2 x 10 mm	<b>LG11-143-007</b>
Bite 3 x 10 mm	<b>LG11-144-008</b>
Bite 4 x 10 mm	<b>LG11-145-009</b>

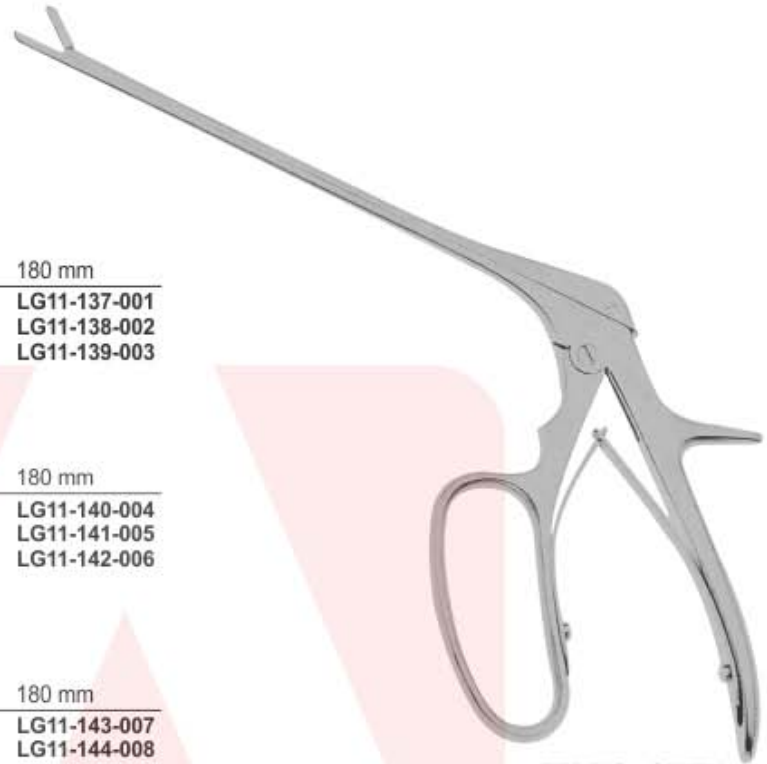

FERRIS - SMITH



4 mm 5 mm 6 mm



OldBerg Shaft	180 mm
Bite $\varnothing$ 4 mm	<b>LG11-146-001</b>
Bite $\varnothing$ 5 mm	<b>LG11-147-002</b>
Bite $\varnothing$ 6 mm	<b>LG11-148-003</b>

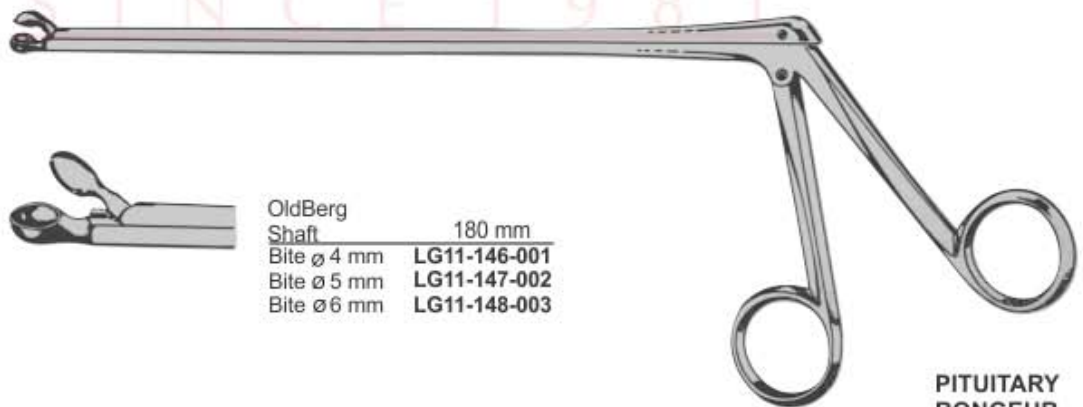

PITUITARY  
RONGEUR



# LAMINECTOMY RONGEURS

Laminektomieztangen

Pinzas Para Laminectomía

Pinces Pour Laminectomie

Pinze Per Laminectomia

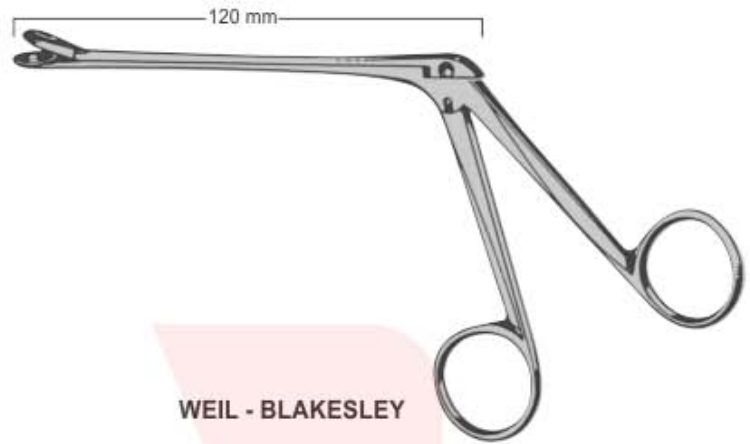

S I N C E 1 9 8 1

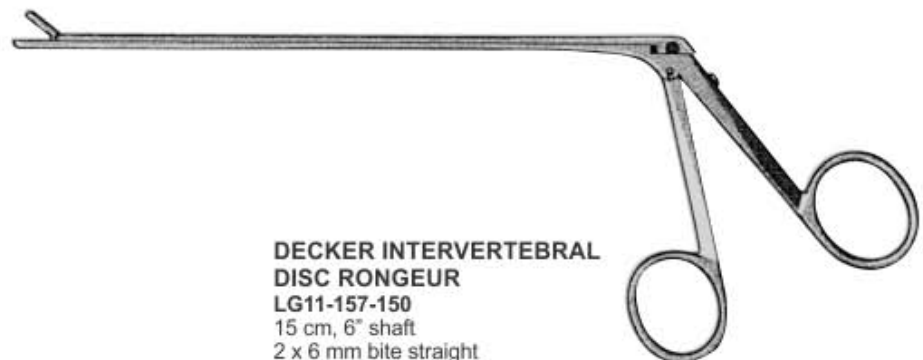
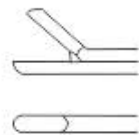



# LAMINECTOMY RONGEURS

Laminektomieztangen  
Pinzas Para Laminectomía

Pinces Pour Laminectomie  
Pinze Per Laminectomia



Working length 14 mm



**MICRO GRASPING  
FORCEPS**  
LG11-158-001  
serrated, straight

**MICRO ALLIGATOR  
SCISSORS**  
LG11-159-002  
straight



**LG11-160-001**  
Ø1.0 mm  
Straight



**LG11-161-002**  
Ø2.0 mm  
Straight



**LG11-162-003**  
Ø3.0 mm  
Straight



**LG11-163-004**  
Ø1.0 mm  
angled up



**LG11-164-005**  
Ø2.0 mm  
curved to right



**LG11-165-006**  
Ø3.0 mm  
curved to left



**MIRCO CUP  
FORCEPS**

S I N C E 1 9 8 1



**LG11-166-180**  
Grasping Forceps  
Ø3 mm



**LG11-167-180**  
Cup Forceps  
Ø2 mm



**LG11-168-180**  
Alligator Scissors  
Ø2 mm



**MICRO ALLIGATOR  
FORCEPS**  
with tubular shaft  
18 cm, 7"



# DURA HOOKS / NERVE HOOKS

Duramesser, Durahaken,  
Durahaken, Nerv-und Gefäßhäkchen

Couteaux Pour Dure-mère, Crochets Pour Dure-mère,  
Crochets Pour Dure-mère, Crochets à Nerfs Et à Vaisseaux

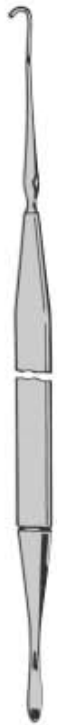

**SCOVILLE**  
LG11-169-300  
30 cm, 12"  
Nerve Hook and  
Dissector



**SCOVILLE**  
LG11-170-300  
30 cm, 12"  
Nerve Hook and  
Dissector

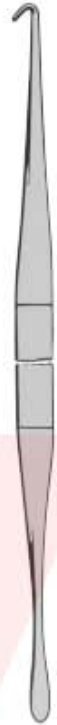

**SCOVILLE**  
LG11-171-300  
30 cm, 12"  
Sympathectomy Hook  
and Dissector



**LG11-172-190**  
Davis  
4 mm, 19 cm, 7 1/2"



**LG11-173-200**  
Sachs  
3 mm, 20 cm, 8"



**LG11-174-200**  
Sachs  
6 mm, 20 cm, 8"

## NERVE SEPARATOR & SPATULA



**FRAZIER**  
LG11-175-125  
12.5 cm, 5"



**GILLIES**  
LG11-177-190  
19 cm, 7 1/2"



**LG11-176-190**  
Small



**LG11-177-190**  
large



**LG11-178-130**  
Straight  
13 cm, 5"



**LAHEY CLINIC**  
LG11-179-130  
13 cm, 5"



**SACHS**  
LG11-180-185  
18.5 cm, 7 1/4"



**LG11-181-160**  
16 cm, 6 1/2"



**TOENNIS**  
LG11-182-150  
15 cm, 6"



**DURA  
TWIST HOOK**  
LG11-183-140  
14 cm, 5 1/2"





## LAMINA SPREADERS

Wirbelkörperspreizer  
Separadores Para Cuerpos Vertebrales

Ecarteurs Pour Corps Vertébraux  
Separatori Per Vertebre



**INGE**  
**LG11-184-160**  
16 cm, 6 1/2"  
Small pattern

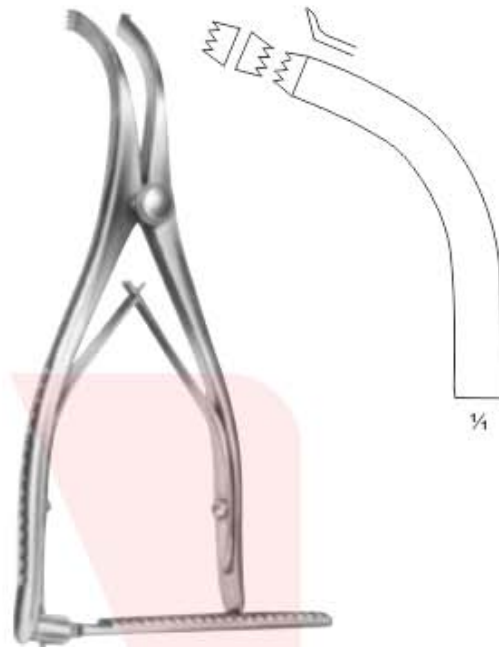

**INGE**  
**LG11-185-170**  
17 cm, 6 3/4"



**INGE**, 26 cm, 10 1/4"  
**LG11-186-260** Jaw width 5 mm  
**LG11-187-260** Jaw width 10 mm  
large pattern



**CLOWARD**  
**LG11-188-130**  
13 cm, 5"



## NERVE ROOT RETRACTORS, BRAIN SPATULAS

*Duradisektoren, Neuwurzelhaken,  
Separadores Para La Raiz De Nervio,*

*Dissecteurs à Dure-mère,  
Dissettori Per La Dura-madre*

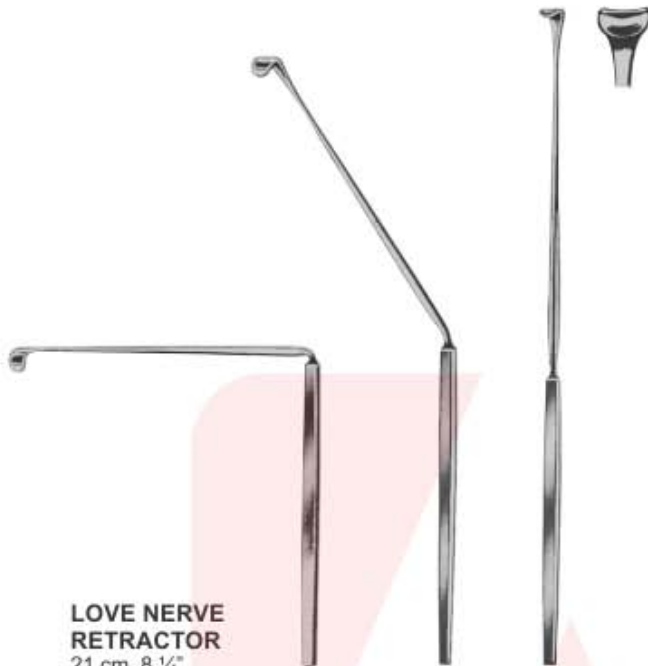

### LOVE NERVE RETRACTOR

21 cm, 8 1/4"  
7 mm width x 5 mm depth

- LG11-189-210 Straight blade
- LG11-190-210 blade angled 45 degrees
- LG11-191-210 blade angled 90 degrees



LG11-193-002  
Love modif.  
5 mm, 110 mm

LG11-194-003  
Love modif.  
7 mm, 110 mm

LOVE MODIF.  
LG11-192-001  
4 mm, 100 mm



### HOLSHER NERVE RETRACTOR

LG11-195-230 23 cm, 9" angled 7 mm blade  
LG11-196-230 9 mm blade



### NERVE ROOT RETRACTOR

LG11-197-001 6 mm blade  
LG11-198-002 9 mm blade  
Offset 225 mm

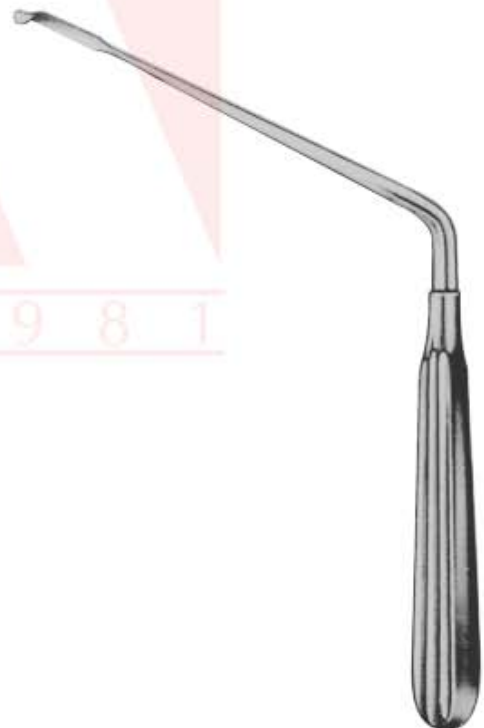

### SCOVILLE NERVE ROOT RETRACTOR

LG11-199-230 8 mm blade  
LG11-200-230 13 mm blade  
23 cm, 9" angled

S I N C E 1 9 8 1