

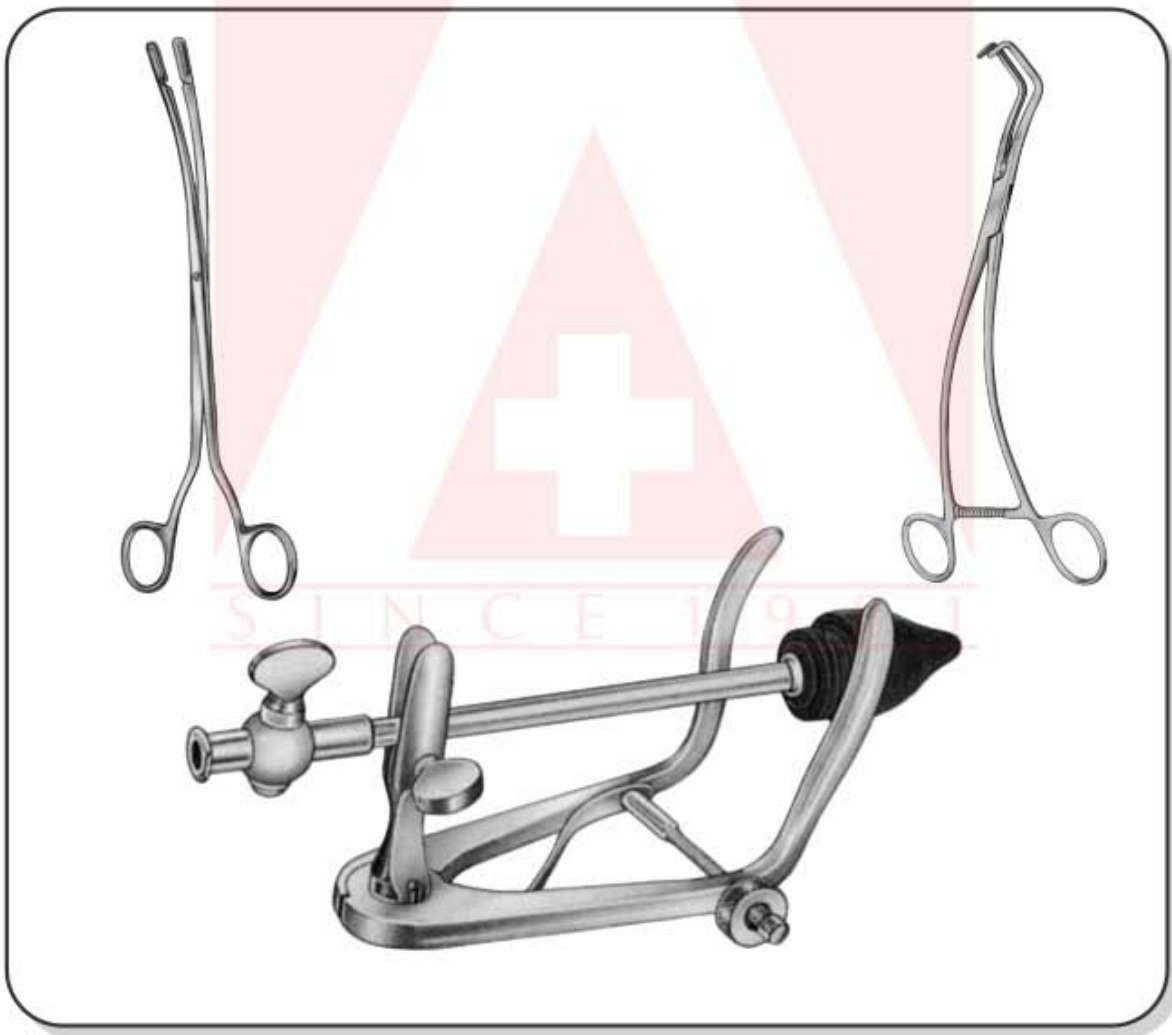

UROLOGY





KIDNEY STONE FORCEPS

Nierensteinzangen
Pinzas para cálculoa renales

Pinces pour les calculs du bassin
Pinze per calcoli renali



RANDALL

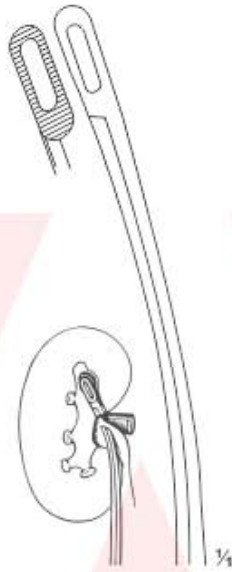

LG15-001-230
23 cm, 9"

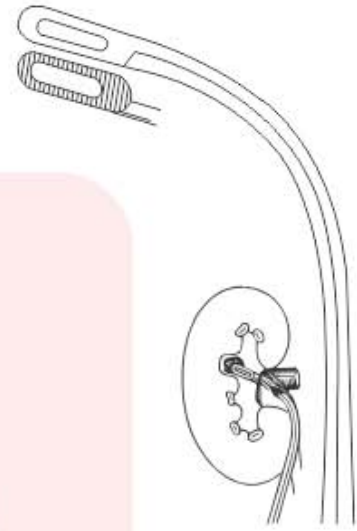

LG15-002-230
23 cm, 9"

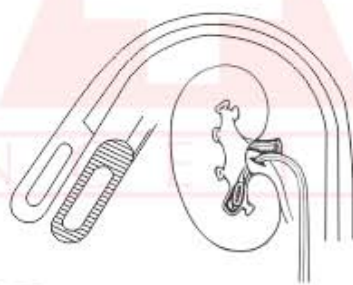

LG15-003-230
23 cm, 9"

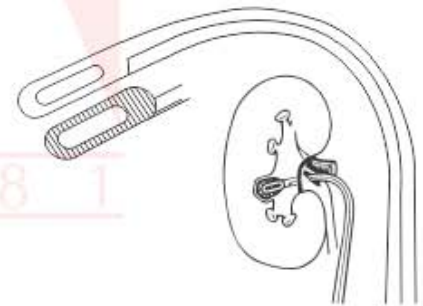

LG15-004-230
23 cm, 9"



PROSTATIC RETRACTOR

Prostatahaken
Separadores para próstata

Ecarteurs prostatiques
Divaricatori prostatici

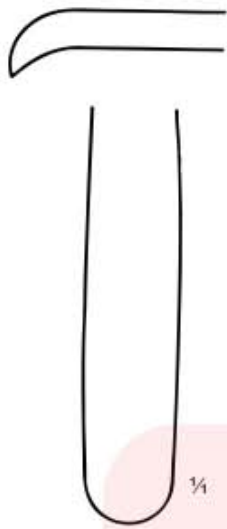

YOUNG
LG15-005-210
21 cm, 8 1/4"
11 x 50 mm

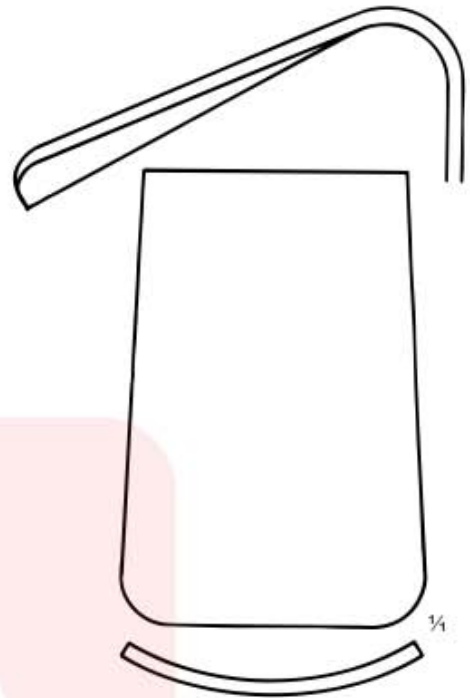

YOUNG
LG15-006-220
22 cm, 8 3/4"
38 x 64 mm



YOUNG
LG15-007-210
21 cm, 8 1/4"
25 x 25 mm

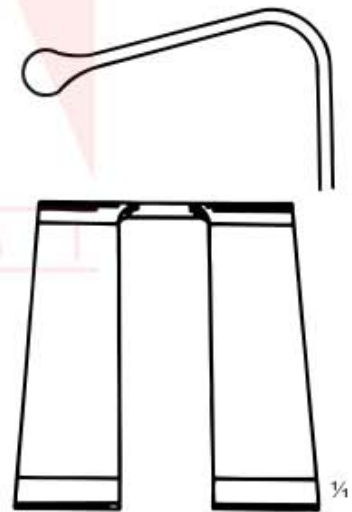

YOUNG
LG15-008-220
22 cm, 8 3/4"
39 x 35 mm



GALL DUCT DILATOR

Gallenkanaldilatatore
Gallensteinzangen

Dilatateurs pour les voies biliaires
Pincés pour calculs biliaires

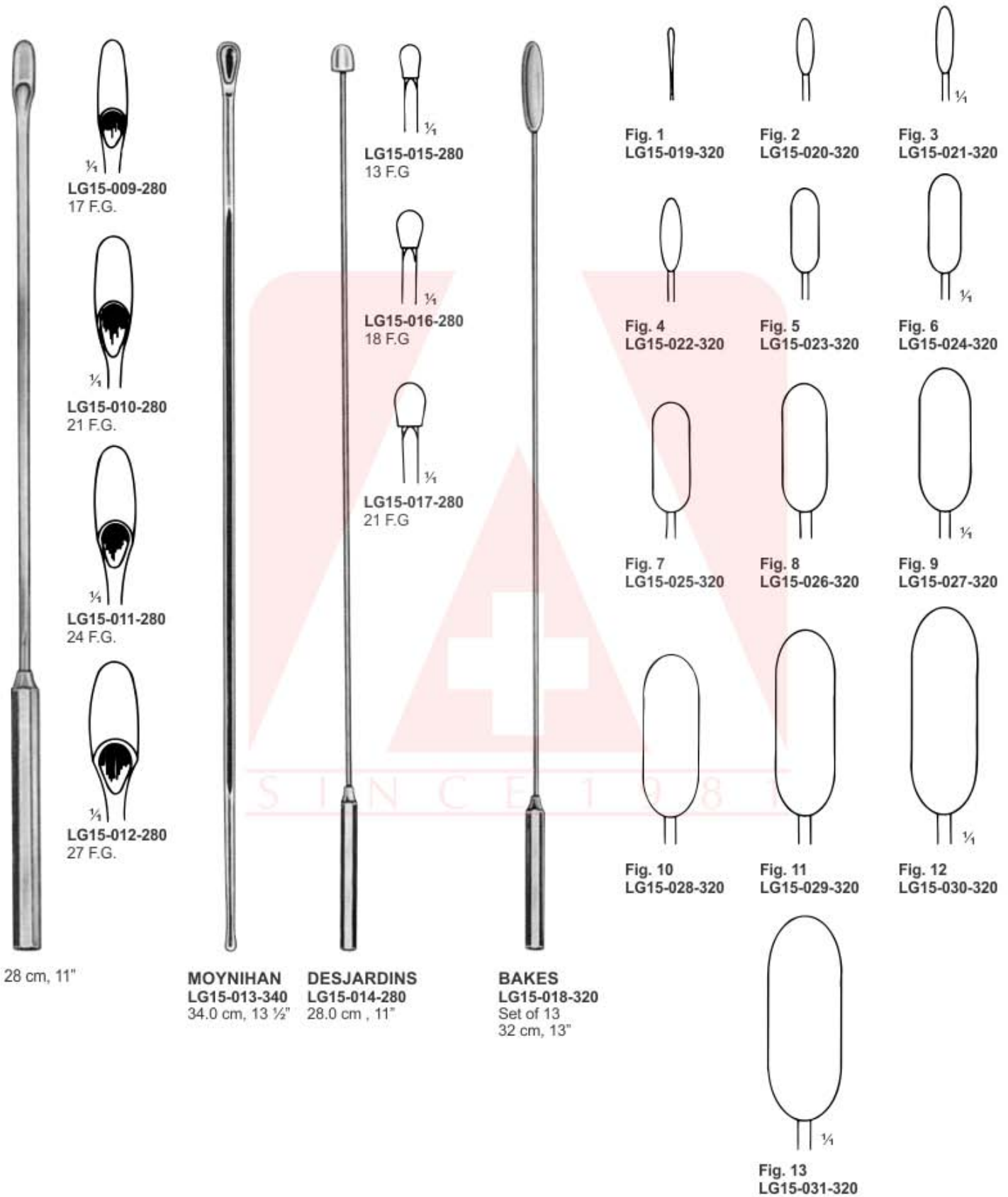



URETHRAL CATHETERS

Urethalkatheter
Sondes Urétrales

Cateteri Uretrali
Catéteres Uretrales



CATHETER
LG15-032-150
15 cm, 6"
No. 6-16



CATHETERS
LG15-033-290 29 cm, 11 1/2"
Male Catheters charr., Metal
French
LG15-034-01 8
LG15-035-02 10
LG15-036-03 12
LG15-037-04 14
LG15-038-05 16
LG15-039-06 18
LG15-040-07 20



LISTER BOUGIES
LG15-041-270
27 cm, 10 3/4"
00 / 1 to 15 / 18
set of 17



CLUTTON BOUGIES
LG15-042-270 27 cm, 10 3/4"
06 / 10 FG to 28 / 32
set of 12



VAN BUREN
A TO O
Set of 15

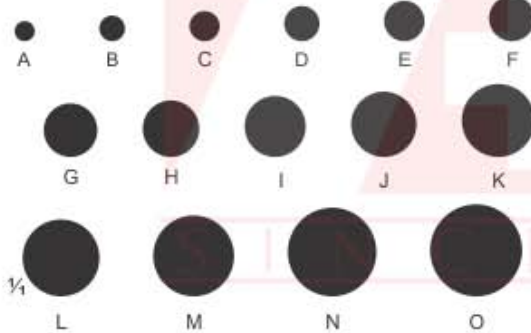
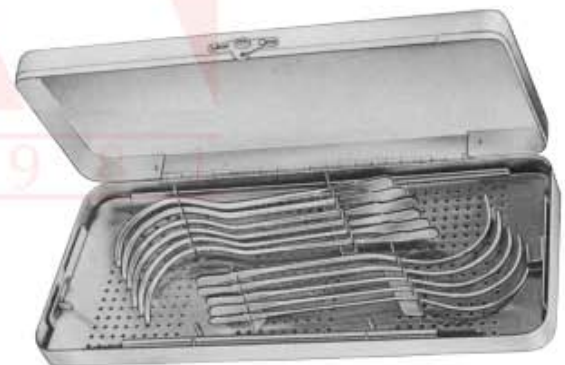

Fig.	Item	Description	Inches	Dia. Charr
A	LG15-043-280	28 cm	11"	8 French
B	LG15-044-280	28 cm	11"	10 French
C	LG15-045-280	28 cm	11"	12 French
D	LG15-046-280	28 cm	11"	14 French
E	LG15-047-280	28 cm	11"	16 French
F	LG15-048-280	28 cm	11"	18 French
G	LG15-049-280	28 cm	11"	20 French
H	LG15-050-280	28 cm	11"	22 French
I	LG15-051-280	28 cm	11"	24 French
J	LG15-052-280	28 cm	11"	26 French
K	LG15-053-280	28 cm	11"	28 French
L	LG15-054-280	28 cm	11"	30 French
M	LG15-055-280	28 cm	11"	32 French
N	LG15-056-280	28 cm	11"	34 French
O	LG15-057-280	28 cm	11"	36 French



GUYON
LG15-058-001
420 x 175 x 40 mm
Set in metal case containing:
— 21 Bougies Guyon
— 6 filiform Bougies



URETHRAL CATHETERS

Urethalkatheter
Sondes Urétrales

Cateteri Uretrali
Catéteres Uretrales



	Charr. (French)
LG15-060-008	8
LG15-061-009	9
LG15-062-010	10
LG15-063-011	11
LG15-064-012	12
LG15-065-013	13
LG15-066-014	14
LG15-067-015	15
LG15-068-016	16
LG15-069-017	17
LG15-070-018	18
LG15-071-019	19
LG15-072-020	20
LG15-073-021	21
LG15-074-022	22
LG15-075-023	23
LG15-076-024	24
LG15-077-025	25
LG15-078-026	26
LG15-079-027	27
LG15-080-028	28
LG15-081-029	29
LG15-082-030	30

DITTEL
LG15-059-225
22.5 cm, 8 3/4"
urethral bougies and
dilating sounds



	Charr. (French)
LG15-084-008	8
LG15-085-009	9
LG15-086-010	10
LG15-087-011	11
LG15-088-012	12
LG15-089-013	13
LG15-090-014	14
LG15-091-015	15
LG15-092-016	16
LG15-093-017	17
LG15-094-018	18
LG15-095-019	19
LG15-096-020	20
LG15-097-021	21
LG15-098-022	22
LG15-099-023	23
LG15-100-024	24
LG15-101-025	25
LG15-102-026	26
LG15-103-027	27
LG15-104-028	28
LG15-105-029	29
LG15-106-030	30

DITTEL
LG15-083-350
35 cm, 14"
urethral bougies and
dilating sounds



	Charr. (French)
LG15-108-330	3
LG15-109-330	4
LG15-110-330	5
LG15-111-330	6

LG15-107-330
33 cm, 13"
filiform guides,
olive tip



	Charr. (French)
LG15-113-008	Ben. 24 / Charr. 12
LG15-114-009	Ben. 25
LG15-115-010	Ben. 26 / Charr. 13
LG15-116-011	Ben. 27
LG15-117-012	Ben. 28 / Charr. 14
LG15-118-013	Ben. 29
LG15-119-014	Ben. 30 / Charr. 15
LG15-120-015	Ben. 31
LG15-121-016	Ben. 32 / Charr. 16
LG15-122-017	Ben. 33
LG15-123-018	Ben. 34 / Charr. 17
LG15-124-019	Ben. 35
LG15-125-020	Ben. 36 / Charr. 18
LG15-126-021	Ben. 37
LG15-127-022	Ben. 38 / Charr. 19
LG15-128-023	Ben. 39
LG15-129-024	Ben. 40 / Charr. 20
LG15-130-025	Ben. 41
LG15-131-026	Ben. 42 / Charr. 21
LG15-132-027	Ben. 43
LG15-133-028	Ben. 44 / Charr. 22
LG15-134-029	Ben. 45
LG15-135-030	Ben. 46 / Charr. 23
LG15-136-031	Ben. 47
LG15-137-032	Ben. 48 / Charr. 24
LG15-138-033	Ben. 49
LG15-139-034	Ben. 50 / Charr. 25
LG15-140-035	Ben. 51
LG15-141-036	Ben. 52 / Charr. 26
LG15-142-037	Ben. 53
LG15-143-038	Ben. 54 / Charr. 27
LG15-144-039	Ben. 55
LG15-145-040	Ben. 56 / Charr. 28
LG15-146-041	Ben. 57
LG15-147-042	Ben. 58 / Charr. 29
LG15-148-043	Ben. 59
LG15-149-044	Ben. 60 / Charr. 30

GUYON
LG15-112-250
25 cm, 10"
urethral bougies and
dilating sounds
without filiform guides,
with thread in tip



GALL STONE FORCEPS

Gallensteinzangen
Gallensteinlöffel

Pinces pour calculs biliaires
Curettes pour calculs biliaires



BLAKE
LG15-150-200 20 cm, 8"



BLAKE
LG15-151-200 20 cm, 8"



MAYO-BLAKE
LG15-152-200 20 cm, 8"



MAYO-BLAKE
LG15-153-200 20 cm, 8"



BLADDER NECK SPREADER, BLADDER RETRACTORS

Blasenhalsperrer, Blasenwundsperrer

Ecarteur pour le col de la vessie, Ecarteurs vésicaux

Dilatador para el cuello vesical, Separadores vesicales

Divaricatore del collo vescicale, Divaricatore vescicale



KNUTSON
LG15-154-180
18 cm, 7"
Urethrographie-Instruments

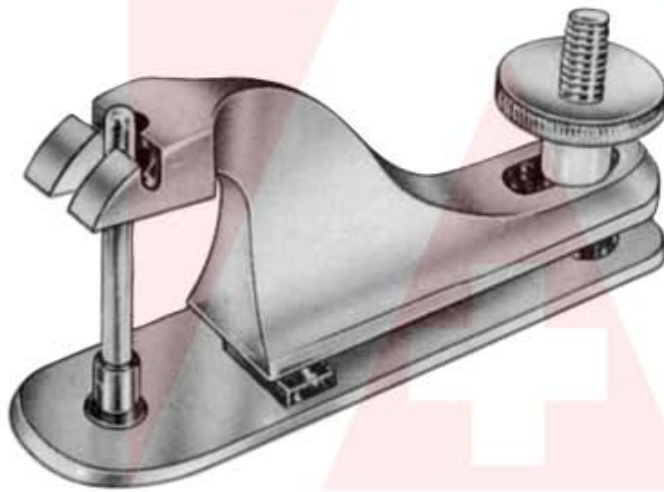

GUMCO CLAMP

	mm Ø
LG15-155-008	8
LG15-156-011	11
LG15-157-013	13
LG15-158-016	16
LG15-159-021	21
LG15-160-026	26
LG15-161-032	32

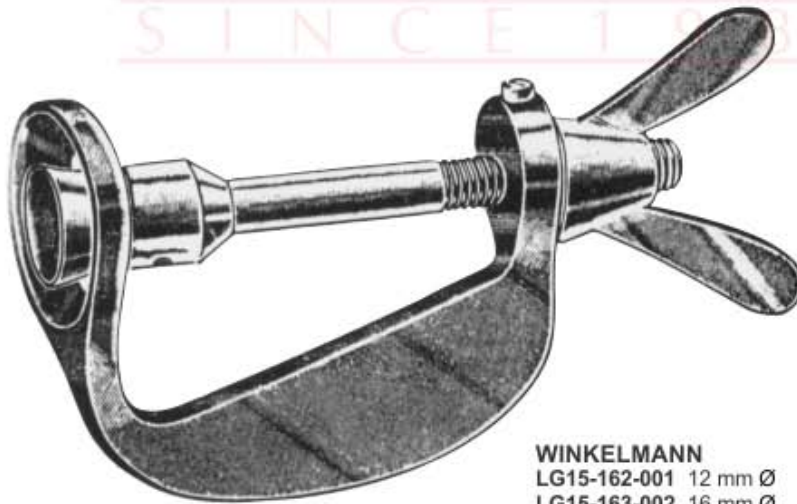

WINKELMANN
LG15-162-001 12 mm Ø
LG15-163-002 16 mm Ø
LG15-164-003 20 mm Ø
Circumcision clamps