

Dental Catalogue

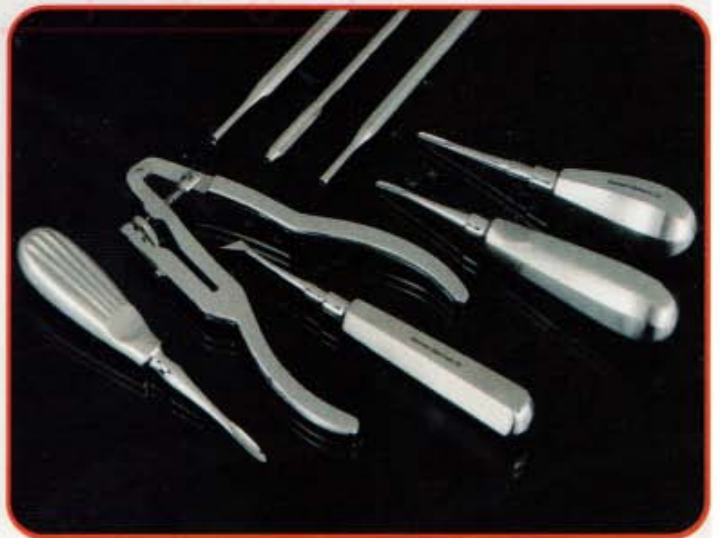

Allegro Surgical Corporation

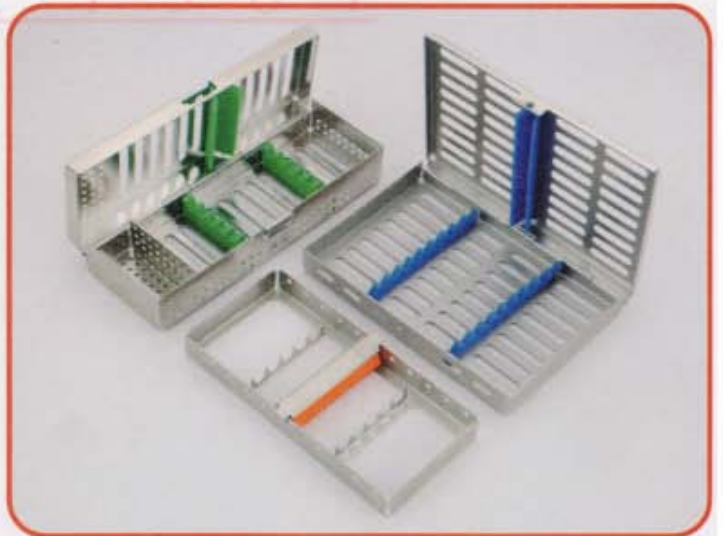

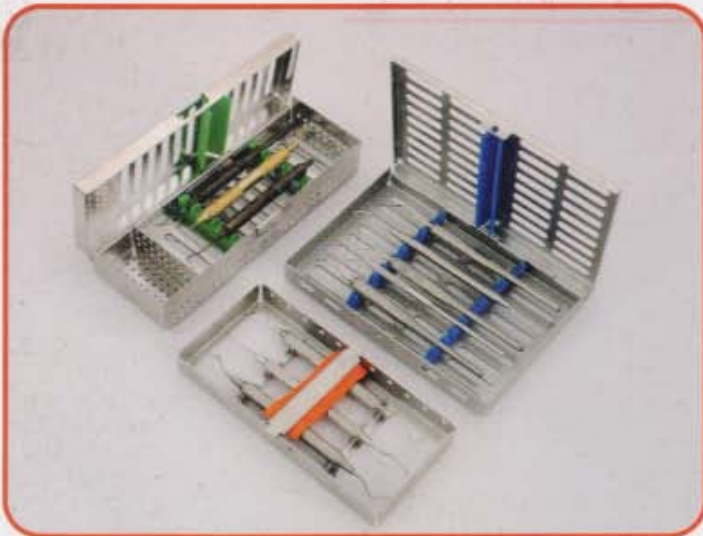
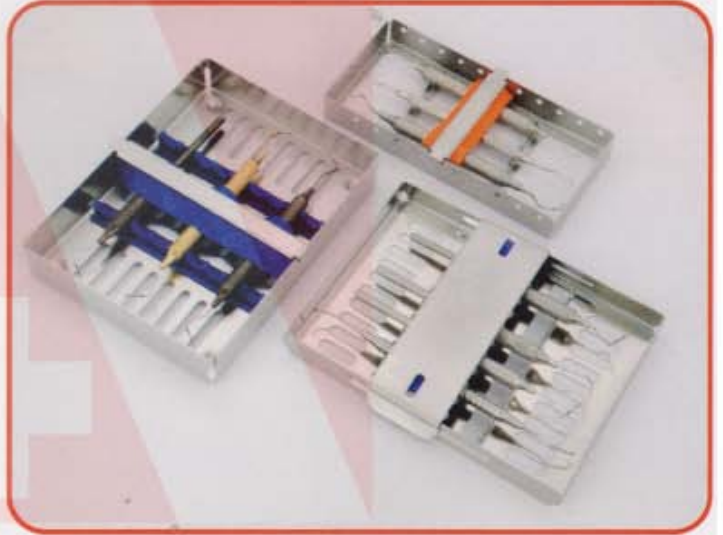
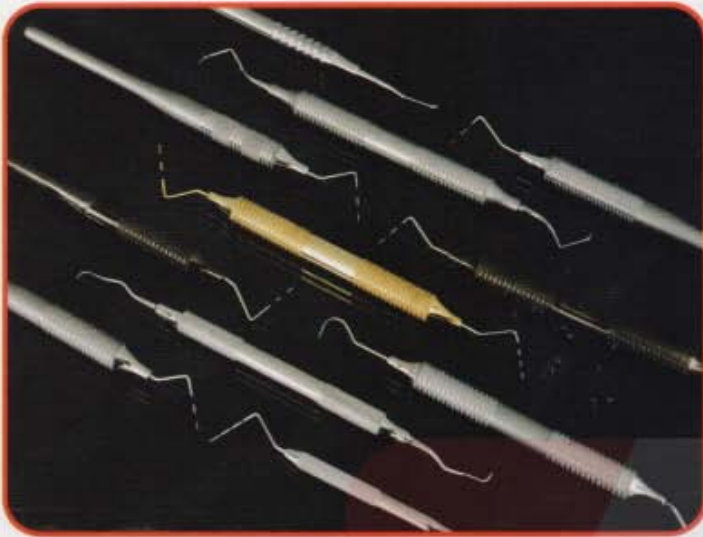

SINCE 1981



MILLER
Blades (0,1,2,3,4,5)

MC-INTOSH
Blades (1,2,3,4)



MILLER
Blades (0,1,2,3,4,5)

MC-INTOSH
Blades (1,2,3,4)



GUEDEL-NEGUS
Blades (1,2,3,4)

MILLER + MC-INTOSH + GUEDEL-NEGUS
Laryngoscope Battery Handle for
Adult C type 2 batteries
Standard Illumination Manufactured

FIBER OPTIC
MILLER, MC-INTOSH
Laryngoscope Battery Handle for
Adult C type 2 batteries
Halogen Illumination Manufactured



Flexible Laryngoscope
Conventional
Halogen Illumination
Available blade sizes 2,3 & 4



LED LIGHT
Halogen illumination
laryngoscope for bright view



Laryngoscope MC-INTOSH
Special Allegro Edition



Mini Fiber Optic Otoscope



Fiber Optic Otoscope



Mini Ophthalmoscope



Standard Ophthalmoscope



DIAGNOSTIC SET

786-789

2.5 V Standard illumination for use with 2 batteries C type.

Including:

Otoscope Head: Luir Lock fitting. Chrome plated.

Fix lens 4 x in plastic mount can be removed for introduction of instruments.

Specula sizes: 2.5, 3.5 & 4.5 mm Included, Ophthalmoscope head: Luir Lock fitting.

Lens selection wheel permits choice of corrective lenses from 0 to -20 and 0 to +20 diopters.

Single large circle aperture.

Bent-arm illuminator: pin contact fitting. Nasal speculum: Chrome plated.

Two laryngeal mirrors: n. 4 and 5.

Battery handle: 28mm. For 2 cell C-batteries.

Chrome plated. For adjustment of all illumination.

Replacement bulb: 2.5 V Diagnostic set is supplied in new beautiful

look and quality Black Case, which protect our quality

Products from moisturizing and damaging.



DERMO SCOPE



TONGUE DEPRESSOR



INTRODUCTION

In 1956 Mr. Feroz Baig started his business single handed and was a maker of surgical instruments in local market. He was very technical, skilled in hand made instruments, buyers just provide instrument and patterns and he developed the instruments by hand.

In 1967 His two elder sons Azeem & Aaleam baig join his father local business and contact with foreign buyers, they used new equipments and designs for instruments, they were very appreciated by foreign buyers and they started the export under the company "HEALTH & WEALTH"

In 1977 The 3rd younger brother M. Anwar Baig join the company and well trained by his father & big brothers, it is the time when they boost the business with efficiency & hard working of Mr. Anwar Baig and they produce a huge variety of instruments.

In 1981 Mr. Anwar Baig establish his company Allegro surgical corp. where from he got a great confidence and trust of medical professionals and company became a world known healthcare source in medical community.

2007-2011

Now Mr.Imran Baig is running the company and from his period of joining company growing very smoothly and also launched company branches in USA, ITALY, BELGIUM.

Now the Allegro is a GROUP of listed companies

Allegro Surgical Corp (Serving for Surgical, Dental & Holloware)

Allegro Tools (Serving for Jewelry, Optial, Watch & General Tools)

Allegro Inc (Serving for Beauty Care Instruments)

Mr.Baig also started a project for big factory unit for Allegro which is almost going to complete soon.

www.allegro.com.pk (Allegro Surgical Corp)

www.allegro-tools.com (Allegro Tools)

www.allegro-inc.us (Allegro inc (USA) (Beauty Care)



Description	Page #
Extracting Forceps	01-36
Root Elevators	37-59
Scalers, Probes & Spatulas	60-74
Oral & Maxillo-facial Surgery Instruments	75-95
Orthodontic Instruments, Orthodontic Pliers, Cutters, Impression Trays & Articulators	96-112
Dental Implant Instruments	113-128
Index	129-132



Extracting Forceps

- English Pattern
- American Pattern



Extracting Forceps (English Pattern) Zahnzangen (Englische Form)

Daviers (Forme Anglaise) Forcés de Extracción (Forme Inglesa)



ID-12-0001
1
obere Schneide- und Eckzähne
upper laterals and canines
incisives et canines supérieures
incisivos y caninos superiores



ID-12-0002
2
obere Schneide- und Eckzähne
upper laterals and canines
incisives et canines supérieures
incisivos y caninos superiores



ID-12-0003
3
obere Schneide- und Eckzähne
upper laterals and canines
incisives et canines supérieures
incisivos y caninos superiores



ID-12-0004
4
untere Schneide- und Eckzähne
lower laterals and canines
incisives et canines inférieures
incisivos y caninos inferiores



ID-12-0007
7
obere Prämolaren
upper premolars
prémolaires supérieures
premolares superiores



ID-12-0008
8
untere Prämolaren
lower premolars
prémolaires inférieures
premolares inferiores



ID-12-0013
13
untere Prämolaren
lower premolars
prémolaires inférieures
premolares inferiores

EXTRACTING FORCEPS (English Pattern)



Extracting Forceps (English Pattern)
Zahnzangen (Englische Form)

Daviers (Forme Anglaise)
Forcets de Extraction (Forme Inglesa)



ID-12-0013S
13S
 untere Prämolaren, für Kinder
 lower premolars, for children
 Prémolaires inférieures, pour enfants
 premolares inferiores para niños



ID-12-0017
17
 obere Molaren, rechts
 upper molars, right
 molaires supérieures droites
 molares superiores derechos



ID-12-0018
18
 obere Molaren, links
 upper molars, left
 molaires supérieures gauches
 molares superiores izquierdos

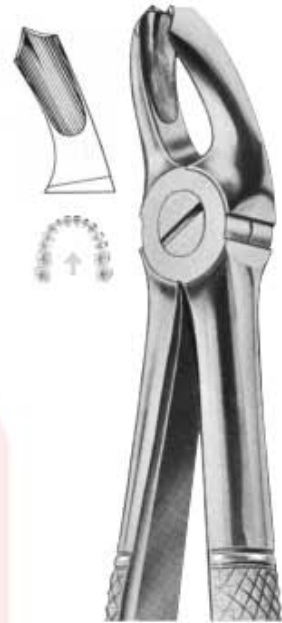

ID-12-0018A
18A
 obere Molaren
 upper molars
 molaires supérieures
 molares superiores



ID-12-0018B
18B
 obere Molaren
 upper molars
 molaires supérieures
 molares superiores



ID-12-0019
19
 obere dritte molaren
 upper third molars
 troisièmes molaires supérieures
 terceros molares superiores



Extracting Forceps (English Pattern)
Zahnzangen (Englische Form)

Daviers (Forme Anglaise)
Forcés de Extracción (Forme Inglesa)



ID-12-0029
29
 obere wurzeln
 upper roots
 recines supérieures
 raices superiores



ID-12-0029S
29S
 obere wurzeln, für kinder
 upper roots, for children
 recines supérieures, pour enfants
 raices superiores, para niños

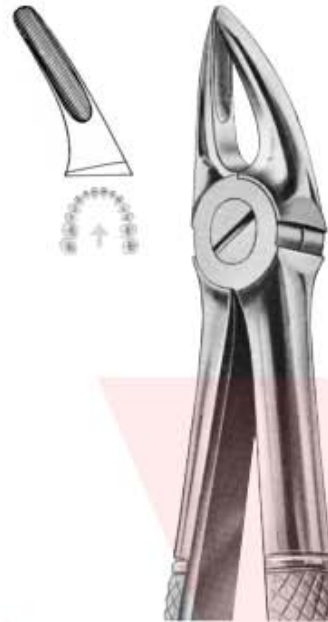

ID-12-0030
30
 obere wurzeln
 upper roots
 recines supérieures
 raices superiores

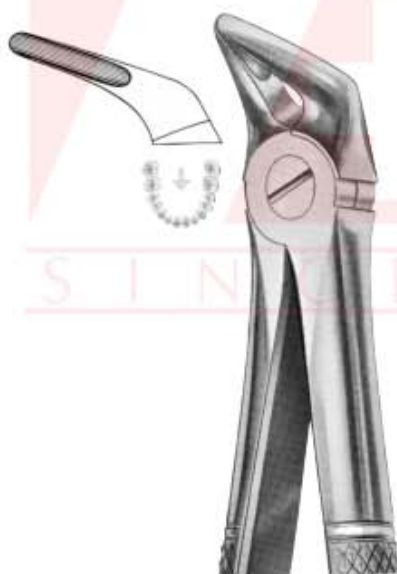

ID-12-0031
31
 untere wurzeln
 lower roots
 recines inférieures
 raices inferiores



ID-12-0032
32
 untere wurzeln
 lower roots
 recines inférieures
 raices inferiores



ID-12-0030S
30S
 obere wurzeln, für kinder
 upper roots, for children
 recines supérieures, pour enfants
 raices superiores, para niños

SINCE 1931



Extracting Forceps (English Pattern)
Zahnzangen (Englische Form)

Daviers (Forme Anglaise)
Forcets de Extracción (Forme Inglesa)



ID-12-0033
33
 untere wurzeln
 lower roots
 racines inférieures
 raíces inferiores



ID-12-0033A
33A
 untere wurzeln
 lower roots
 racines inférieures
 raíces inferiores



ID-12-0033B
33B
 untere wurzeln
 lower roots
 racines inférieures
 raíces inferiores

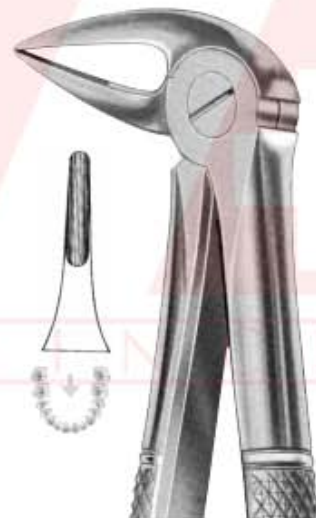

ID-12-0033L
33L
 untere wurzeln
 lower roots
 racines inférieures
 raíces inferiores



ID-12-0037
37
 oberer Schneidezähne, für kinder
 upper incisors, for children
 incisivos superiores, pour enfants
 incisivos superiores, para niños



ID-12-0033S
33S
 untere Wurzeln, für kinder
 lower roots, for children
 racines inférieures, pour enfants
 raíces inferiores, para niños

EXTRACTING FORCEPS (English Pattern)



Extracting Forceps (English Pattern)
Zahnzangen (Englische Form)

Daviers (Forme Anglaise)
Forceps de Extracción (Forme Inglesa)



ID-12-0038
38
 untere Schneide- und Eckzähne, für Kinder
 lower incisors and canines, for children
 incisives et canines inférieures, pour enfants
 incisivos y caninos inferiores, para niños



ID-12-0039
39
 obere Molaren,
 für Kinder
 upper molars
 for children
 molaires supérieures,
 pour enfants
 molares superiores,
 para niños



ID-12-0039R
39 R
 obere Molaren rechts,
 für Kinder
 upper molars right
 for children
 molaires supérieures,
 droites, pour enfants
 molares superiores,
 derechos, para niños



ID-12-0039L
39 L
 obere Molaren links,
 für Kinder
 upper molars left
 for children
 molaires supérieures,
 gauches, pour enfants
 molares superiores,
 izquierdos, para niños

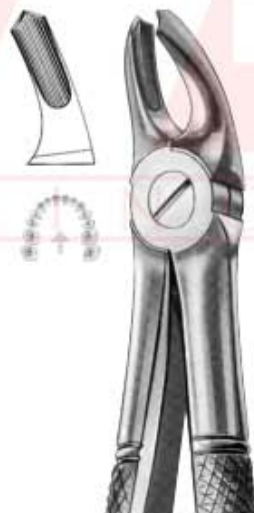

ID-12-0039A
39 A
 obere Molaren,
 für Kinder
 upper molars
 for children
 molaires supérieures,
 pour enfants
 molares superiores,
 para niños



ID-12-0040
40
 untere Molaren,
 für Kinder
 lower molars
 for children
 molaires inférieures,
 pour enfants
 molares inferiores,
 para niños



**Extracting Forceps (English Pattern)
Zahnzangen (Englische Form)**

**Daviers (Forme Anglaise)
Forceps de Extracción (Forme Inglesa)**



**ID-12-0041
41**
obere Wurzeln
upper roots
racines supérieures
raíces superiores

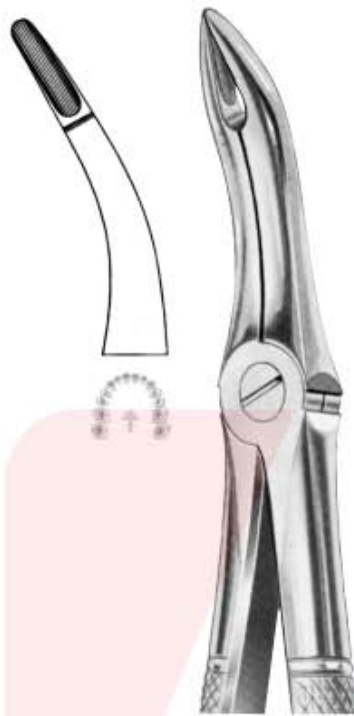

**ID-12-0044
44**
obere Wurzeln
upper roots
racines supérieures
raíces superiores

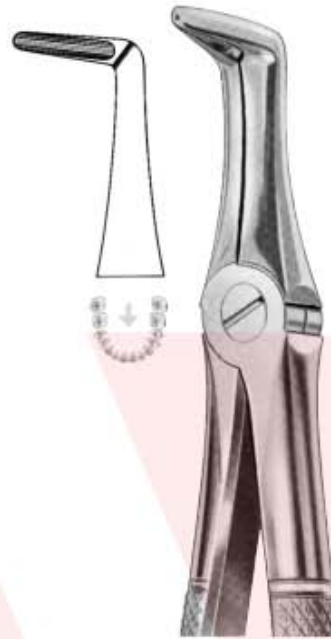

**ID-12-0045
45**
untere Wurzeln
lower roots
racines inférieures
raíces inferiores

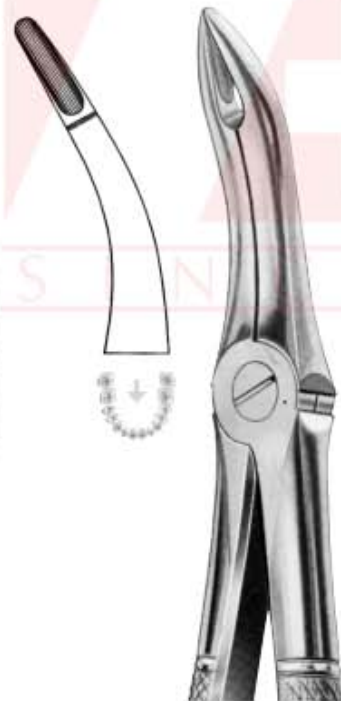

**ID-12-0048
48**
untere Wurzeln
lower roots
racines inférieures
raíces inferiores



**ID-12-0049
49**
obere Wurzeln
upper roots
racines supérieures
raíces superiores



**ID-12-0050
50**
obere Wurzeln
upper roots
racines supérieures
raíces superiores

**Extracting Forceps (English Pattern)
Zahnzangen (Englische Form)**

**Daviers (Forme Anglaise)
Forceps de Extracción (Forme Inglesa)**



**ID-12-0051
51**
obere Wurzeln
upper roots
racines supérieures
raíces superiores

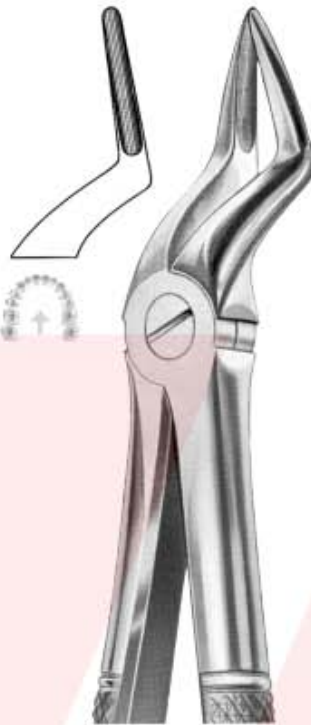

**ID-12-0051A
51 A**
obere Wurzeln
upper roots
racines supérieures
raíces superiores



**ID-12-0051L
51 L**
obere Wurzeln
upper roots
racines supérieures
raíces superiores



**ID-12-0051S
51 S**
obere Wurzeln für Kinder
upper roots, for children
racines supérieures, pour enfants
raíces superiores, para niños



**ID-12-0052
52**
obere Wurzeln
upper roots
racines supérieures
raíces superiores

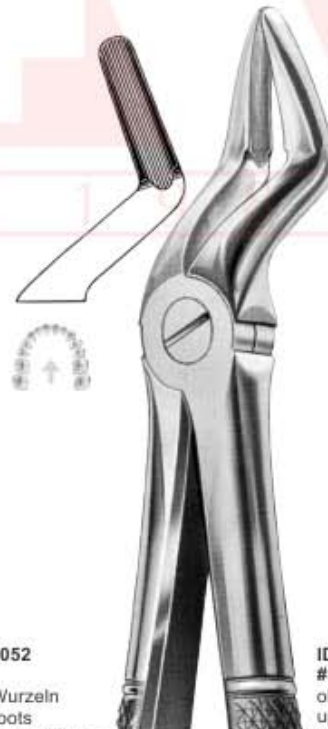

**ID-12-0052A
52 A**
obere Zähne und Resektion
upper teeth and resection
dents supérieures et résection
dientes superiores y resección



Extracting Forceps (English Pattern) Zahnzangen (Englische Form)

Daviers (Forme Anglaise) Forceps de Extracción (Forme Inglesa)



ID-12-0054
54
Spaltzange für obere Molaren
for separating upper molars
à séparer molaires supérieures
para separar molares superiores

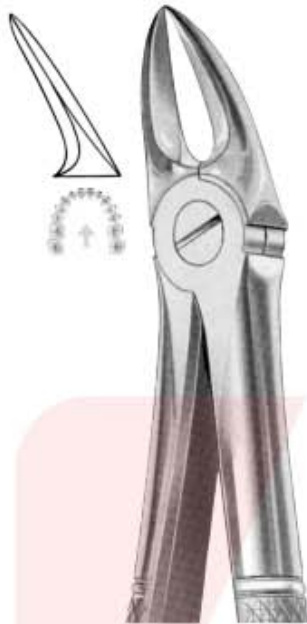

ID-12-0055
55
Spaltzange für obere Molaren
for separating upper molars
à séparer molaires supérieures
para separar molares superiores



ID-12-0056
56
Spaltzange für untere Molaren
for separating lower molars
à séparer molaires inférieures
para separar molares inferiores



ID-12-0065R
65 R
obere Molaren, rechts
upper molars, right
molaires supérieures droites
molares superiores derechos

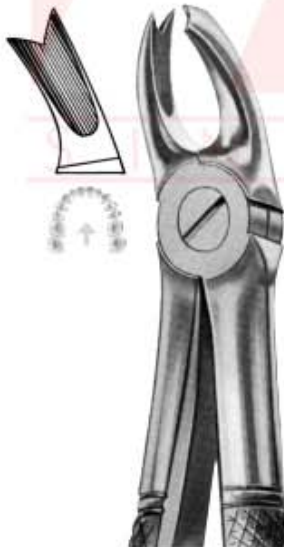

ID-12-0065L
65 L
obere Molaren, links
upper molars, left
molaires supérieures gauches
molares superiores izquierdos



ID-12-0067
67
obere dritte Molaren
upper third molars
troisièmes molaires supérieures
terceros molares superiores



ID-12-0067A
67 A
obere dritte Molaren
upper third molars
troisièmes molaires supérieures
terceros molares superiores



Extracting Forceps (English Pattern)
Zahnzangen (Englische Form)

Daviers (Forme Anglaise)
Forceps de Extracción (Forme Inglesa)



ID-12-0067 1/2 R
67 1/2 R
obere dritte Molaren, rechts
upper third molars, right
troisième molaires supérieures, droites
terceros molares superiores, derechos

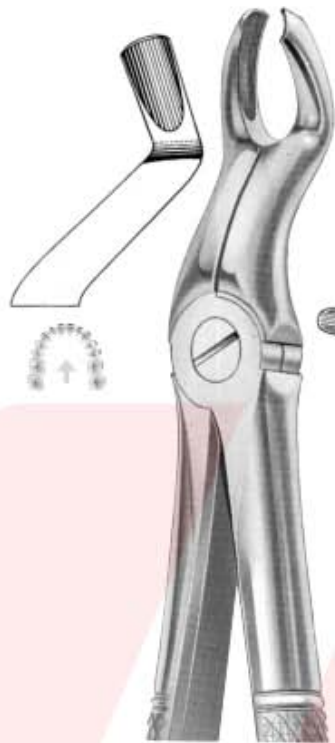

ID-12-0067 1/2 L
67 1/2 L
obere dritte Molaren, links
upper third molars, left
troisième molaires
supérieures, gauches
terceros molares
superiores, izquierdos



ID-12-0068
68
untere Wurzeln
lower roots
racines inférieures
raíces inferiores



ID-12-0068A
68 A
untere Wurzeln
lower roots
racines inférieures
raíces inferiores

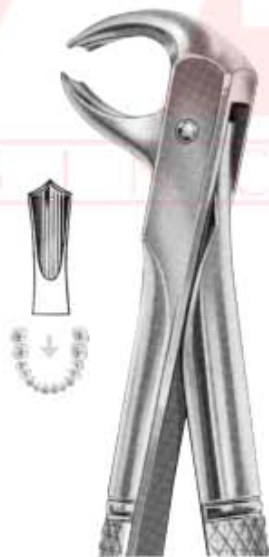

ID-12-0073
73
untere Molaren
lower molars
molaires inférieures
molares inferiores



ID-12-0073R
73 R
untere Molaren, rechts
lower molars, right
molaires inférieures, droites
molares inferiores, derechos



ID-12-0073L
73 L
untere Molaren, links
lower molars, left
molaires inférieures, gauches
molares inferiores, izquierdos

EXTRACTING FORCEPS (English Pattern)



Extracting Forceps (English Pattern)
Zahnzangen (Englische Form)

Daviers (Forme Anglaise)
Forceps de Extracción (Forme Inglesa)



ID-12-0073A
73 A
untere Molaren
lower molars
molaires inférieures
molares inferiores



ID-12-0073S
73 S
untere Molaren
lower molars
molaires inférieures
molares inferiores



ID-12-0073B
73 B
untere Molaren
für Kinder
lower molars
for children
molaires inférieures,
pour enfants
molares inferiores,
para niños



ID-12-0073K
73 K
untere Molaren
für Kinder
lower molars
for children
molaires inférieures,
pour enfants
molares inferiores,
para niños



ID-12-0074
74
untere Wurzeln
lower roots
racines inférieures
raíces inferiores



ID-12-0074D
74 D
untere Wurzeln
lower roots
racines inférieures
raíces inferiores



Extracting Forceps (English Pattern)
Zahnzangen (Englische Form)

Daviers (Forme Anglaise)
Forceps de Extracción (Forme Inglesa)



ID-12-0074M
74M
 untere wurzeln
 lower roots
 recines inférieures
 raíces inferiores



ID-12-0074N
74N
 untere wurzeln
 lower roots
 recines inférieures
 raíces inferiores



ID-12-0074XN
74XN
 untere Wurzeln und eng-
 stehende schneidezähne
 lower roots and crowded
 incisors
 recines inférieures et
 incisives surdents
 raíces inferiores e incisivos
 supernumerarios



ID-12-0076N
76N
 obere wurzeln
 upper roots
 recines supérieures
 raíces superiores



ID-12-0075
75
 untere Prämolaren
 lower premolars
 prémolaires inférieures
 premolares inferiores



ID-12-0076
76
 obere wurzeln
 upper roots
 recines supérieures
 raíces superiores

Extracting Forceps (English Pattern)
Zahnzangen (Englische Form)

Daviers (Forme Anglaise)
Forceps de Extracción (Forme Inglesa)



ID-12-0076S
76S
obere wurzeln
upper roots
racines supérieures
raíces superiores



ID-12-0079
79
untere dritte Molaren
lower third molars
troisièmes molaires inférieures
terceros molares inferiores



ID-12-0079A
79A
untere dritte Molaren
lower third molars
troisièmes molaires inférieures
terceros molares inferiores



ID-12-0081
81
untere prämolaren und wurzeln
lower prémolars and roots
Premolaires et racines inférieures
premolares y raíces inferiores



ID-12-0080
80
Molarenwurzeln oben
upper molar roots
racines de molaires supérieures
raíces de molares superiores



Extracting Forceps (English Pattern)
Zahnzangen (Englische Form)

Daviers (Forme Anglaise)
Forceps de Extracción (Forme Inglesa)



ID-12-0086A
86A
untere Molaren
lower molars
molaires inférieures
molares inferiores



ID-12-0086B
86B
untere Molaren
lower molars
molaires inférieures
molares inferiores



ID-12-0086C
86C
untere Molaren
lower molars
molaires inférieures
molares inferiores



ID-12-0089
89
obere molaren, rechts
upper molars, right
molaires supérieures droites
molares superiores derechos



ID-12-0087
87
untere Molaren
lower molars
molaires inférieures
molares inferiores



ID-12-0090
90
obere molaren, links
upper molars, left
molaires supérieures gauches
molares superiores izquierdos

Extracting Forceps (English Pattern)
Zahnzangen (Englische Form)

Daviers (Forme Anglaise)
Forceps de Extracción (Forme Inglesa)



ID-12-0092
92
obere zweite molaren, rechts
upper second molars, right
deuxièmes molaires
supérieures, droites
segundos molares
superiores, derechos



ID-12-0093
93
obere zweite
molaren, links
upper second
molars, left
deuxièmes molaires
supérieures gauches
segundos molares
superiores izquierdos



ID-12-0094
94
obere molaren, rechts
upper molars, right
molaires supérieures droites
molares superiores derechos



ID-12-0091
91
Spaltzange für untere molaren
for separating lower molars
à séparer molaires inférieures
para separar molares

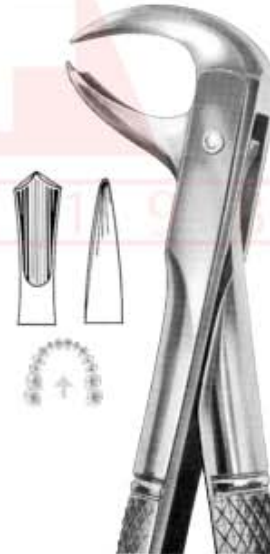

ID-12-0099
099
untere Molaren
lower molars
molaires inférieures
molares inferiores



ID-12-0095
95
obere molaren, links
upper molars, left
molaires supérieures gauches
molares superiores izquierdos

Extracting Forceps (English Pattern)
Zahnzangen (Englische Form)

Daviers (Forme Anglaise)
Forceps de Extracción (Forme Inglesa)



ID-12-0099 ¼
99 ¼
untere Molaren
lower molars
molaires inférieures
molares inferiores



ID-12-0100
100
obere Wurzeln
upper roots
racines supérieures
raices superiores



ID-12-0101
101
obere Pramolaren und wurzeln
upper premolars and roots
prémolaires et racines supérieures
premolares y raices superiores



ID-12-0099 ½
99 ½
untere Molaren
lower molars
molaires inférieures
molares inferiores



Extracting Forceps (English Pattern)
Zahnzangen (Englische Form)

Daviers (Forme Anglaise)
Forceps de Extracción (Forme Inglesa)



ID-12-0104
104
 obere Wurzeln
 upper roots
 racines supérieures
 raíces superiores



ID-12-0102
102
 obere Molaren, rechts
 upper molars, right
 Molaires supérieures droites
 Molares superiores derechos



ID-12-0103
103
 obere Molaren, links
 upper molars, left
 Molaires supérieures gauches
 Molares superiores izquierdos



ID-12-0105
105
 untere Schneidezähne
 lower incisors
 incisiver inférieures
 incisivos inferiores



ID-12-0106
106
 untere Schneidezähne
 lower incisors
 incisiver inférieures
 incisivos inferiores



ID-12-0107
107
 obere Eckzähne
 upper canines
 caninos supérieures
 caninos superiores



Extracting Forceps (English Pattern)
Zahnzangen (Englische Form)

Daviers (Forme Anglaise)
Forceps de Extracción (Forme Inglesa)



ID-12-0112
112
obere Wurzeln
upper roots
racines supérieures
raices superiores



ID-12-0113
113
obere Wurzeln
upper roots
racines supérieures
raices superiores



ID-12-0114
114
untere Wurzeln
lower roots
racines inférieures
raices inferiores



ID-12-0136
136
obere Premolaren und Wurzeln
upper premolars and roots
prémolaires et racines supérieures
premolares y raices superiores



ID-12-0137
137
untere Schneidezähne
und wurzeln
lower incisors and roots
incisives et racines
inférieures
incisivos y raices
inferiores



ID-12-0143
143
untere Wurzeln
lower roots
racines inférieures
raices inferiores

Extracting Forceps (English Pattern)
Zahnzangen (Englische Form)

Daviers (Forme Anglaise)
Forceps de Extracción (Forme Inglesa)

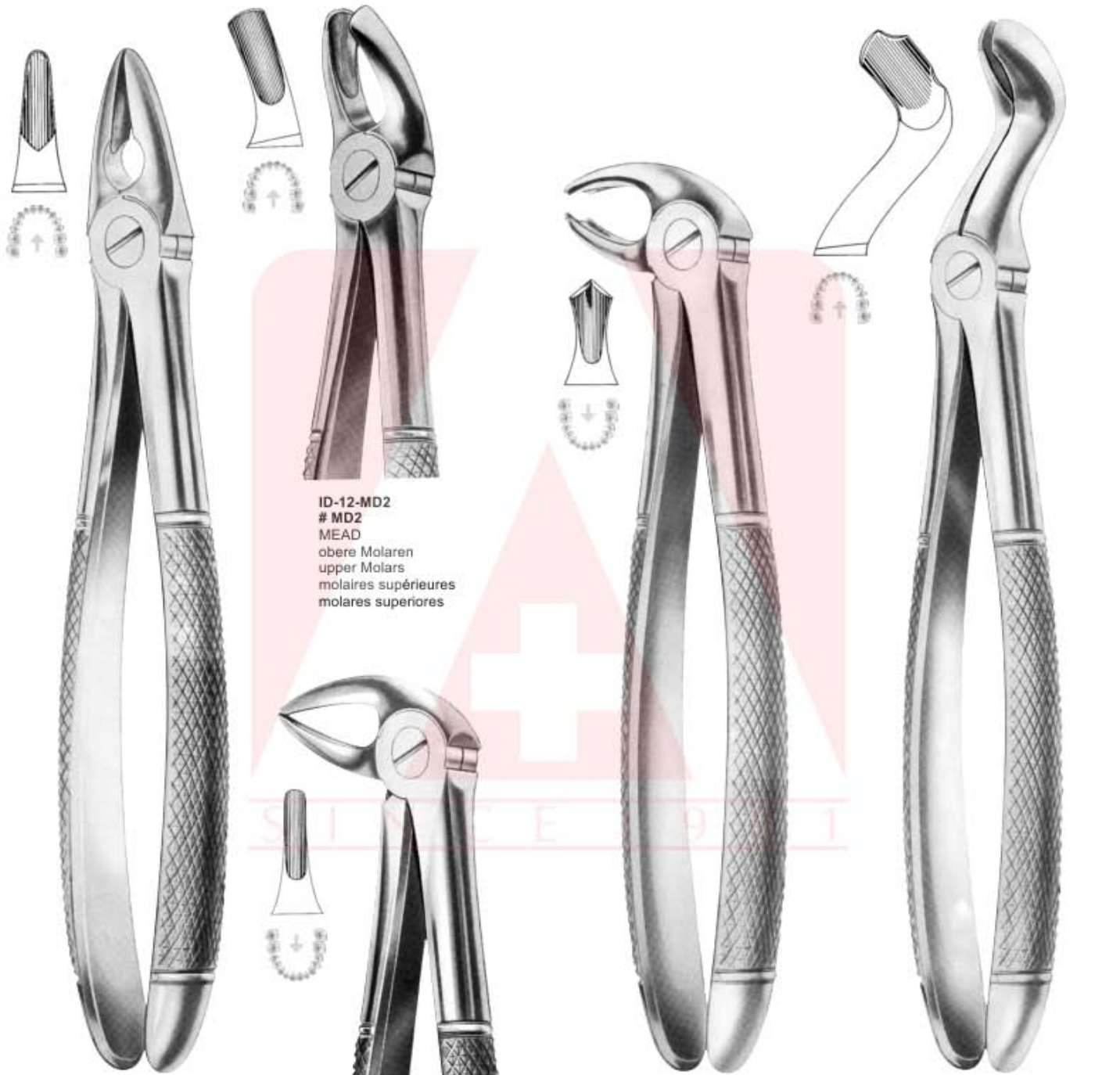

ID-12-MD2
MD2
MEAD
obere Molaren
upper Molars
molaires supérieures
molares superiores

ID-12-MD1
MD1
MEAD
obere Frontzähne, Wurzeln
upper anteriors, roots
incisives, canines,
racines supérieures
incisivos, caninos,
raíces superiores

ID-12-MD3
MD3
MEAD
untere wurzeln
lower roots
racines inférieures
raíces inferiores

ID-12-MD4
MD4
MEAD
untere Molaren
lower Molars
molaires inférieures
molares inferiores

ID-12-0121
121
FELSCH
obere dritte Molaren
upper third molars
troisièmes molaires supérieures
terceros molares superiores

Wisdom Extracting Forceps
Weisheitszahnzangen

Daviers pour dents de sagesse
Forceps para cordales



ID-12-22 ½ L
Routurier
(# 22 ½ L)
Molaren und Weisheitszähne, unten, links
lower molars and wisdoms, left
molaires et dents de sagesse inférieures, gauches
molares y cordales inferiores, lado izquierdo



ID-12-33 ½ L
Routurier
(# 33 ½ L)
Wurzeln unterer Molaren und Weisheitszähne, links
lower molar and wisdom roots, left
racines des molaires et dents de sagesse inférieures, gauches
raíces de molares y cordales inferiores, izquierdos



ID-12-33 ½ R
Routurier
(# 33 ½ R)
Wurzeln unterer Molaren und Weisheitszähne, rechts
lower molar and wisdom roots, right
racines des molaires et dents de sagesse inférieures, droites
raíces de molares y cordales inferiores, derechos

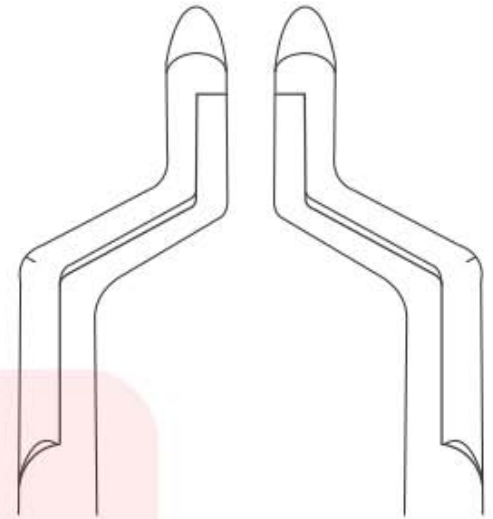

S I N G E 1 9 8 1

Forceps for children
Zahnzangen für Kinder

Daviers pour enfants
Forceps para niños



ID-12-001S
Fig. 1 Baby
obere Schneidezähne
upper incisors
incisives supérieures
incisivos superiores



ID-12-002S
Fig. 2 Baby
obere Prämolaren
upper premolars
prémolaires supérieures
premolares superiores

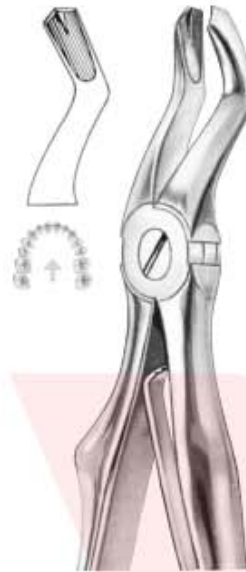

ID-12-003S
Fig. 3 Baby
obere Molaren
upper molars
molaires supérieures
molares superiores



ID-12-004S
Fig. 4 Baby
obere Wurzeln
upper roots
racines supérieures
raices superiores



ID-12-005S
Fig. 5 Baby
untere Schneidezähne
lower incisors
incisives inférieures
incisivos inferiores



ID-12-006S
Fig. 6 Baby
untere Molaren
lower molars
molaires inférieures
molares inferiores



ID-12-007S
Fig. 7 Baby
untere Wurzeln
lower roots
racines inférieures
raices inferiores





Root Splinter Forceps
Wurzelsplitterzangen

Pinces Fragments
Pinzas Para Fragmentos



ID-12-002W
Witzel
obere Wurzeln
upper roots
racines supérieures
raíces superiores



ID-12-001W
Witzel
untere Wurzeln
lower roots
racines inférieures
raíces inferiores



ID-12-001F
Ralk
Wurzelfragmente
root fragments
fragments de racines
fragmentos de raíces

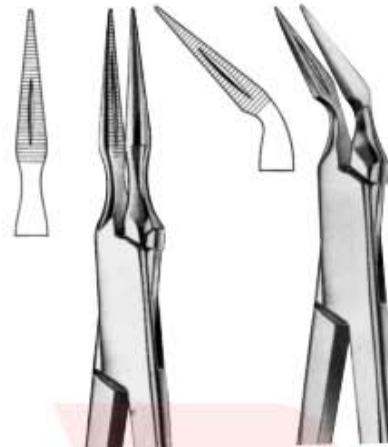

ID-12-003F
Stieglitz
Wurzelfragmente
root fragments
fragments de racines
fragmentos de raíces



ID-12-002F
Stieglitz
Wurzelfragmente
root fragments
fragments de racines
fragmentos de raíces



ID-12-004F
Arthur
Wurzelfragmente
root fragments
fragments de racines
fragmentos de raíces



Extracting Forceps (American Pattern)
Zahnzangen (Amerikanische Form)

Daviers (Forme américaine)
Forceps de Extracción (Forme americana)



DI-12A-00W1
W1
 winter
 obere schneide- und Eckzähne
 upper centrals and canines
 incisives et canines supérieures
 incisivos y caninos superiores

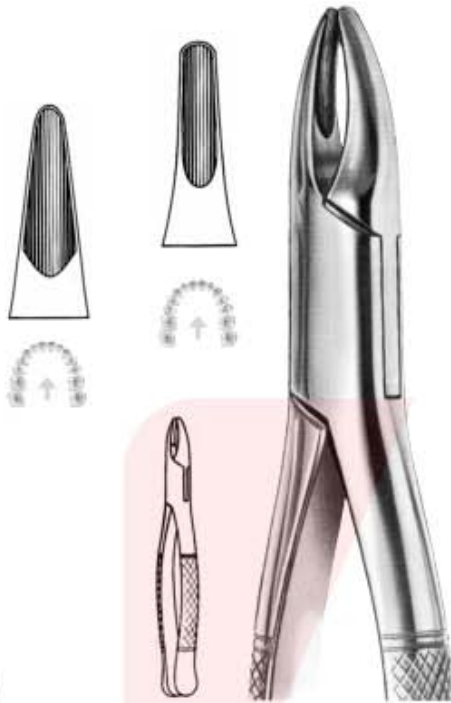

DI-12A-0001
1
 obere schneidezähne und wurzeln
 upper incisors and roots
 incisives et racines supérieures
 incisivos y raíces superiores



DI-12A-0002
2
 obere und untere wurzeln
 upper and lower roots
 racines supérieures et inférieures
 raíces superiores e inferiores

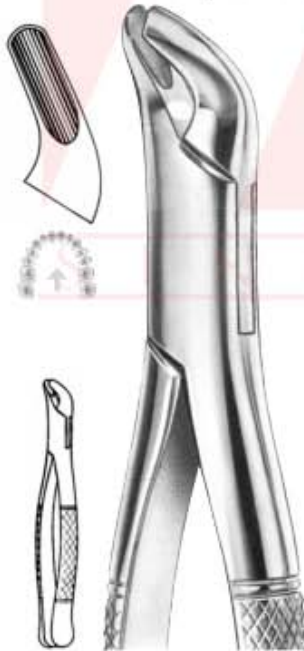

DI-12A-0004
4
 obere und untere prämolaren
 upper and lower premolars
 prémolaires supérieures et inférieures
 premolares superiores e inferiores

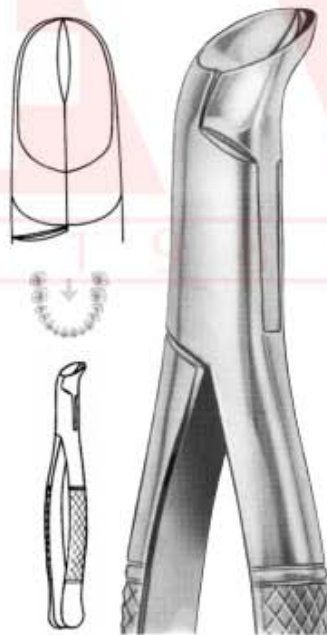

DI-12A-0005
5
 physick
 untere dritte Molaren
 lower third molars
 troisièmes molaires inférieures
 terceros molares inferiores



DI-12A-0006
6
 spaltzange
 separating forceps
 pince à séparer
 forceps para separar

EXTRACTING FORCEPS (American Pattern)



Extracting Forceps (American Pattern)
Zahnzangen (Amerikanische Form)

Daviers (Forme américaine)
Forcés de Extracción (Forme americana)



ID-12A-0007
7
 obere Wurzeln
 upper roots
 racines supérieures
 raices superiores

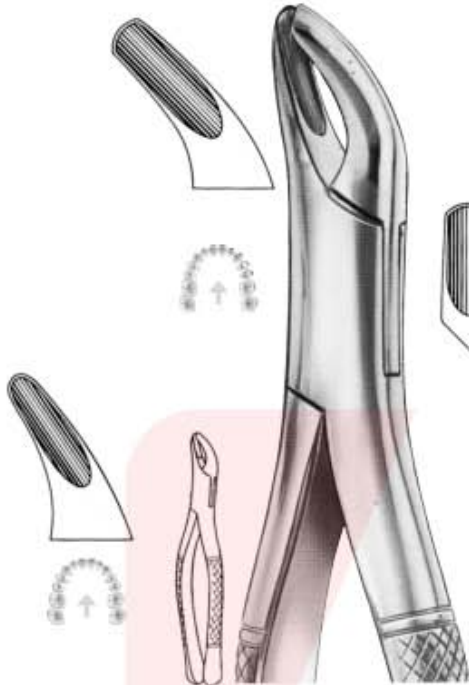

ID-12A-0008
8
 obere und untere dritte Molaren
 upper and lower third molars
 troisièmes molaires supérieures
 et inférieures
 terceros molares superiores y inferiores



ID-12A-0010S
10S
 obere Wurzeln
 upper roots
 racines supérieures
 raices superiores



ID-12A-0010H
10 H
 obere Molaren
 upper molars
 molaires supérieures
 molares superiores

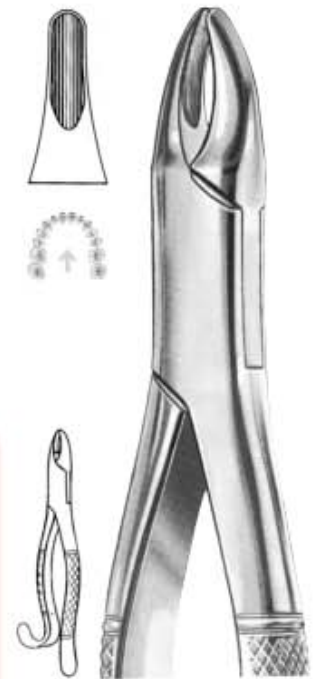

ID-12A-0013
13
 obere Schneidezähne
 upper incisors
 incisives supérieures
 incisivos superiores



ID-12A-0014
14
 untere Schneidezähne
 lower incisors
 incisives inférieures
 incisivos inferiores

EXTRACTING FORCEPS (American Pattern)



Extracting Forceps (American Pattern)
Zahnzangen (Amerikanische Form)

Daviers (Forme américaine)
Forceps de Extracción (Forme americana)

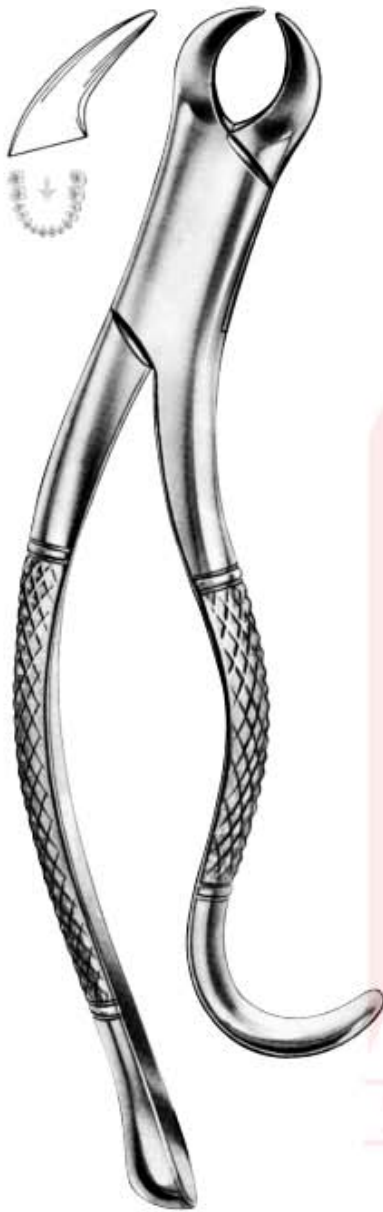

ID-12A-0016
16
untere Molaren
lower molars
molaires inférieures
molares inferiores

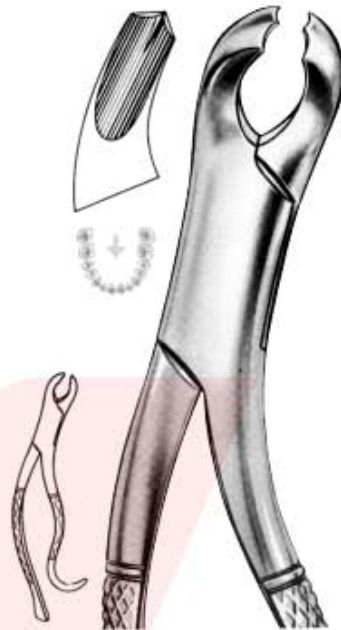

ID-12A-0015
15
Harris
untere Molaren
lower molars
molaires inférieures
molares inferiores



ID-12A-0018L
18 L
Harris
obere Molaren, links
upper molars, left
molaires supérieures gauches
molares superiores izquierdos



ID-12A-0018R
18R
Harris
obere Molaren, rechts
upper molars, right
molaires supérieures droites
molares superiores derechos



ID-12A-0016S
16S
untere molaren, für kinder
lower molars for children
molaires inférieures, pour enfants
molares inferiores, para niños

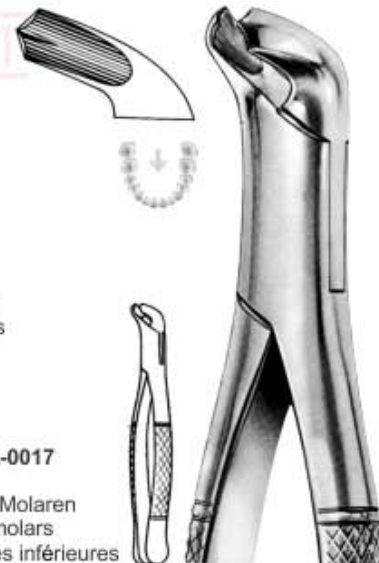

ID-12A-0017
17
untere Molaren
lower molars
molaires inférieures
molares inferiores

EXTRACTING FORCEPS (American Pattern)



Extracting Forceps (American Pattern)
Zahnzangen (Amerikanische Form)

Daviers (Forme américaine)
Forceps de Extracción (Forme americana)

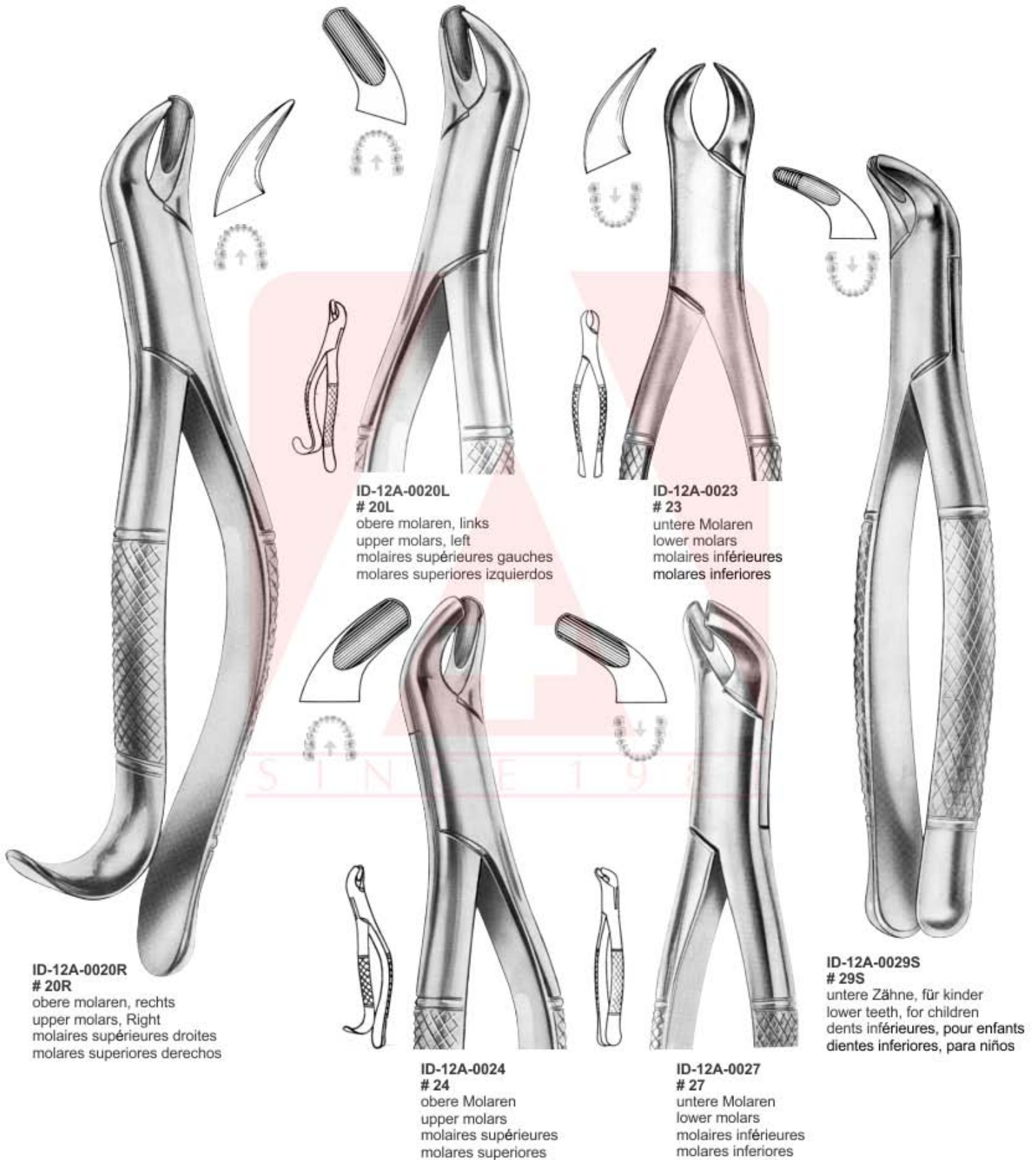

ID-12A-0020L
20L
 obere molaren, links
 upper molars, left
 molaires supérieures gauches
 molares superiores izquierdos

ID-12A-0023
23
 untere Molaren
 lower molars
 molaires inférieures
 molares inferiores

ID-12A-0020R
20R
 obere molaren, rechts
 upper molars, Right
 molaires supérieures droites
 molares superiores derechos

ID-12A-0024
24
 obere Molaren
 upper molars
 molaires supérieures
 molares superiores

ID-12A-0027
27
 untere Molaren
 lower molars
 molaires inférieures
 molares inferiores

ID-12A-0029S
29S
 untere Zähne, für kinder
 lower teeth, for children
 dents inférieures, pour enfants
 dientes inferiores, para niños



**Extracting Forceps (American Pattern)
Zahnzangen (Amerikanische Form)**

**Daviers (Forme américaine)
F forceps de Extracción (Forme americana)**



**ID-12A-0030S
30S**
obere zähne, für kinder
upper teeth, for children
dents supérieures, pour enfants
dientes superiores, para niños



**ID-12A-0032
32 Parmly**
obere Prämolaren und Molaren
upper premolars and molars
prémolaires et molaires supérieures
premolares y molaers superiores

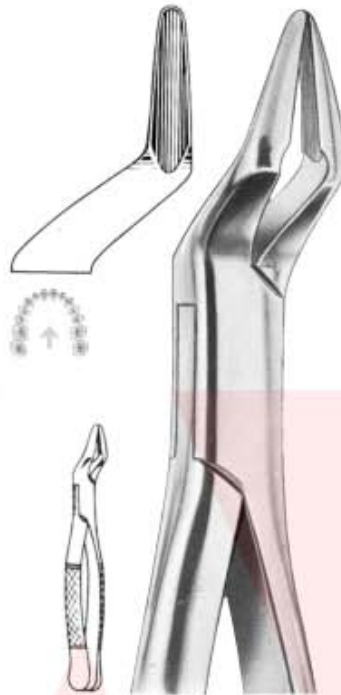

**ID-12A-0032A
32A Parmly**
obere Prämolaren und Wurzeln
upper premolars and roots
prémolaires et racines supérieures
premolares y raíces superiores



**ID-12A-0034
34**
untere zähne, und wurzeln
lower anteriors, and roots
dents et racines, inférieures
dientes y raíces inferiores



**ID-12A-0035
35**
obere Wurzeln
upper roots
racines supérieures
raíces superiores

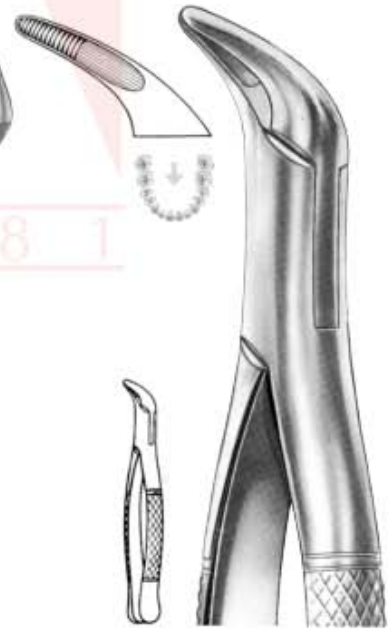

**ID-12A-0036
36**
untere zähne, und wurzeln
lower anteriors, and roots
dents et racines, inférieures
dientes y raíces inferiores

Extracting Forceps (American Pattern)
Zahnzangen (Amerikanische Form)

Daviers (Forme américaine)
Forcés de Extracción (Forme americana)

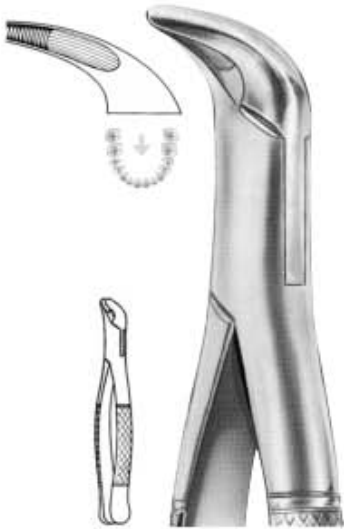

ID-12A-0037
37
untere Zähne und Wurzeln
lower anteriors and roots
dents et racines inférieures
dientes y raíces inferiores



ID-12A-0053R
53 R
obere Molaren, rechts
upper molars, right
molaires supérieures droites
molares superiores derechos



ID-12A-0053 L
53 L
obere Molaren, links
upper molars, left
molaires supérieures gauches
molares superiores izquierdos

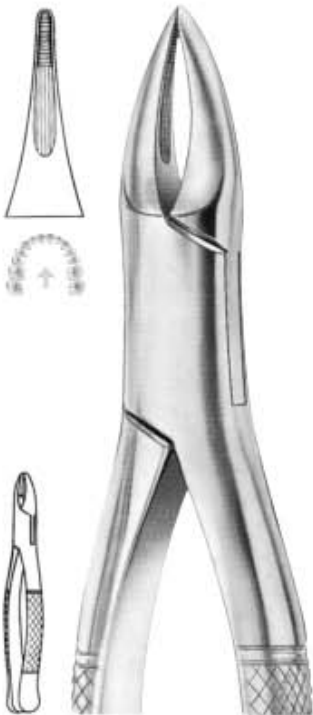

ID-12A-0038
38
obere Zähne und Wurzeln
upper anteriors and roots
dents et racines supérieures
dientes y raíces superiores



ID-12A-0062
62
Schneidezähne, Prämolaren, Milchzähne
incisors, premolars, deciduous teeth
incisives, prémolaires, dents de lait
incisivos, premolares, dientes de leche



ID-12A-0065
65
obere Schneidezähne und Wurzeln
upper incisors and roots
incisives et racines supérieures
incisivos y raíces superiores

EXTRACTING FORCEPS (American Pattern)



Extracting Forceps (American Pattern)
Zahnzangen (Amerikanische Form)

Daviers (Forme américaine)
Forceps de Extracción (Forme americana)



ID-12A-0069
69 Tomas
obere und untere Wurzeln
upper and lower roots
racines supérieures et inférieures
raíces superiores y inferiores



ID-12A-0085
85 Tomas
untere Eckzähne, Pramolaren, Molaren
lower canines, premolars and molars
canines, premoles, molaires infer.
caninos, premoles, molares infer.

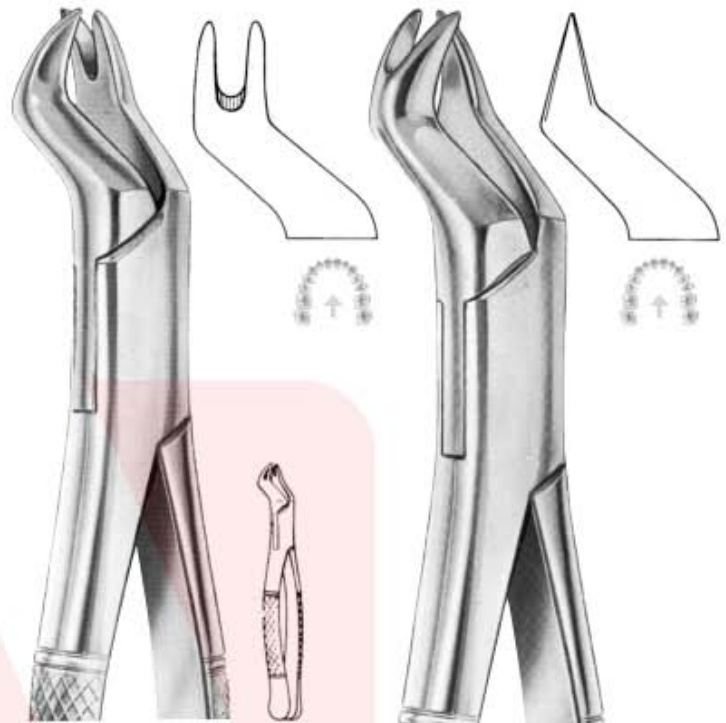

ID-12A-0088R
88R Nevius
obere Molaren, rechts
upper molars, right
molaires supérieures droites
molares superiores derechos



ID-12A-0085A
85A Tomas
untere Eckzähne, Pramolaren, Molaren
lower canines, premolars and molars
canines, premoles, molaires infer.
caninos, premoles, molares infer.

ID-12A-0088L
88L Nevius
obere Molaren, links
upper molars, left
molaires supérieures gauches
molares superiores izquierdos

EXTRACTING FORCEPS (American Pattern)



Extracting Forceps (American Pattern)
Zahnzangen (Amerikanische Form)

Daviers (Forme américaine)
Forceps de Extracción (Forme americana)

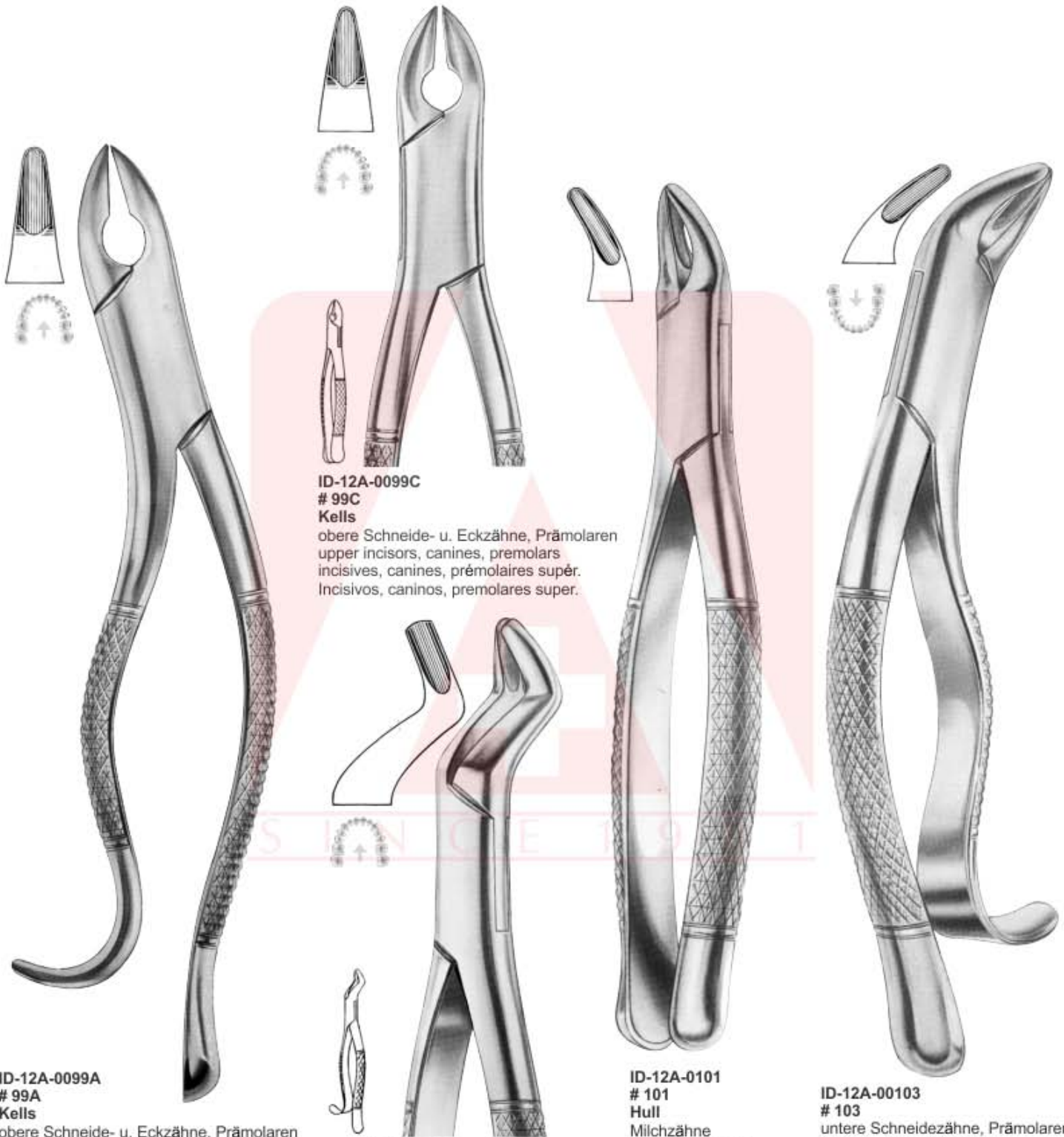

ID-12A-0099C
99C
Kells
 obere Schneide- u. Eckzähne, Prämolaren
 upper incisors, canines, premolars
 incisives, canines, prémolaires supér.
 Incisivos, caninos, premolares super.

ID-12A-0099A
99A
Kells
 obere Schneide- u. Eckzähne, Prämolaren
 upper incisors, canines, premolars
 incisives, canines, prémolaires supér.
 Incisivos, caninos, premolares super.

ID-12A-0104
104
 obere dritte Molaren
 upper third molars
 troisièmes molaires supérieures
 terceros molares superiores

ID-12A-0101
101
Hull
 Milchzähne
 Deciduous teeth
 dents temporaires
 dientes temporales

ID-12A-00103
103
 untere Schneidezähne, Prämolaren
 lower incisors, premolars
 incisives prémolaires, racines infér.
 Incisivos premolares, raices infer.



Extracting Forceps (American Pattern)
Zahnzangen (Amerikanische Form)

Daviers (Forme américaine)
Forceps de Extracción (Forme americana)



ID-12A-0150
150
Cryer
 obere Schneidezähne, Prämolaren
 und Wurzeln
 upper incisors, premolars, roots
 incisives, prémolaires, racines supér.
 Incisivos, premolares, raices super.



ID-12A-0150A
150A
Cryer
 obere Schneidezähne, Prämolaren
 und Wurzeln
 upper incisors, premolars, roots
 incisives, prémolaires, racines supér.
 Incisivos, premolares, raices super.

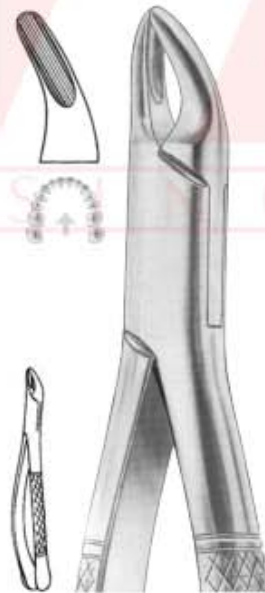

ID-12A-0150S
150S
Cryer
 obere Zähne, für Kinder
 upper teeth, for children
 dents supérieures, pour enfants
 dientes superiores, para niños



ID-12A-0151
151
Cryer
 untere Zähne, für Kinder
 lower teeth, for children
 dents supérieures, pour enfants
 dientes superiores, para niños



ID-12A-0151A
151A
Cryer
 untere Schneidezähne, Prämolaren
 und Wurzeln
 lower incisors, premolars, roots
 incisives, prémolaires, racines infér.
 Incisivos, premolares, raices infer.



ID-12A-0151S
151S
Cryer
 untere Schneidezähne, Prämolaren
 und Wurzeln
 lower incisors, premolars, roots
 incisives, prémolaires, racines infér.
 Incisivos, premolares, raices infer.

Extracting Forceps (American Pattern)
Zahnzangen (Amerikanische Form)

Daviers (Forme américaine)
Forceps de Extracción (Forme americana)



ID-12A-0203
203
 untere Schneidezähne
 und Wurzeln
 lower incisors and roots
 incisives et racines inférieures
 incisivos y raíces inferiores

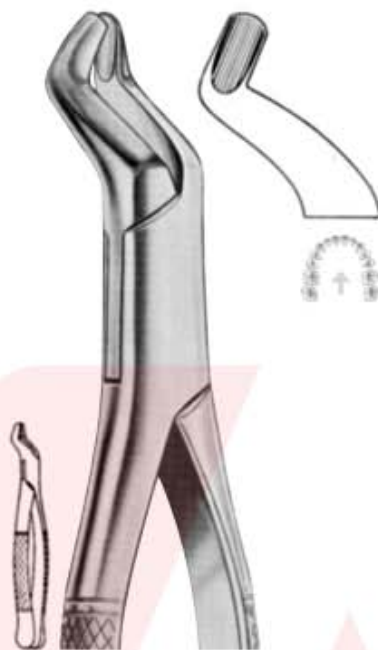

ID-12A-0210S
210S
 obere dritte Molaren
 upper third molars
 troisièmes molaires supérieures
 terceros molares superiores



ID-12A-0201
201
 obere Schneide- u. Eckzähne, Prämolaren
 lower incisors, canines, premolars
 incisives, canines, prémolaires super.
 Incisivos, caninos, premolares super.



ID-12A-0210H
210H
 obere dritte Molaren
 upper third molars
 troisièmes molaires supérieures
 terceros molares superiores

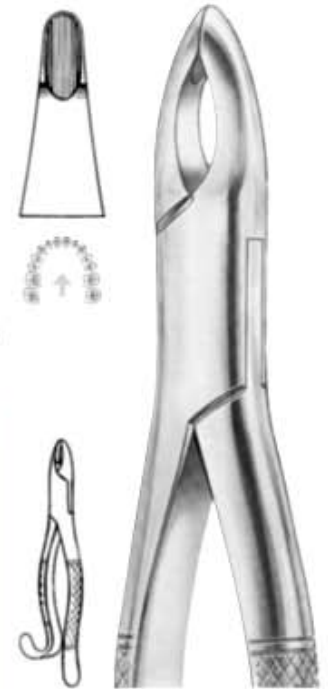

ID-12A-0213
213
 obere Schneide- und Eckzähne
 upper centrals and canines
 incisives et canines supérieures
 incisivos y caninos superiores

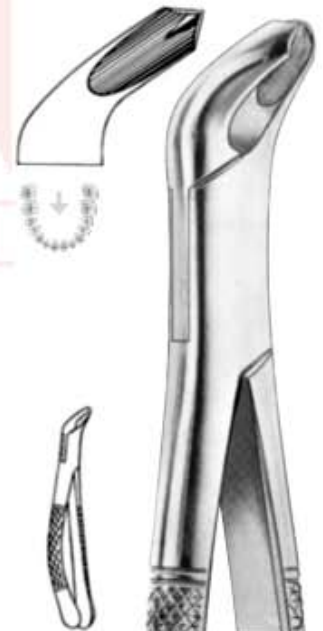

ID-12A-0217
217
 untere Molaren
 lower molars
 molaires inférieures
 molares inferiores

Extracting Forceps (American Pattern)
Zahnzangen (Amerikanische Form)

Daviers (Forme américaine)
Fuerpes de Extracción (Forme americana)



ID-12A-0222
222
untere dritte Molaren
lower third molars
troisièmes molaires inférieures
terceros molares inferiores

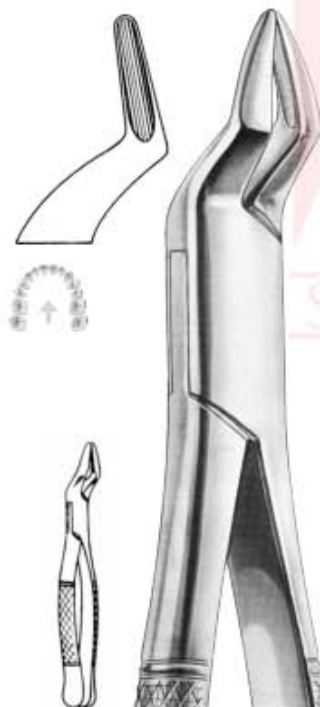

ID-12A-0286
286
obere Schneidezähne und Wurzeln
upper incisors and roots
incisives et racines supérieures
incisivos y raíces superiores



ID-12A-0287
287 Swing
untere Molaren
lower molars
molaires inférieures
molares inferiores



ID-12A-0288
288
untere Eckzähne und Pramolaren
Lower canines and premolars
canines, prémolaires inférieures
caninos, premolares inferiores

Extracting Forceps (American Pattern)
Zahnzangen (Amerikanische Form)

Daviers (Forme américaine)
Forceps de Extracción (Forme americana)



ID-12A-000C1
Cohen
 universalzahnzange
 universal forceps
 davier universal
 forceps universal

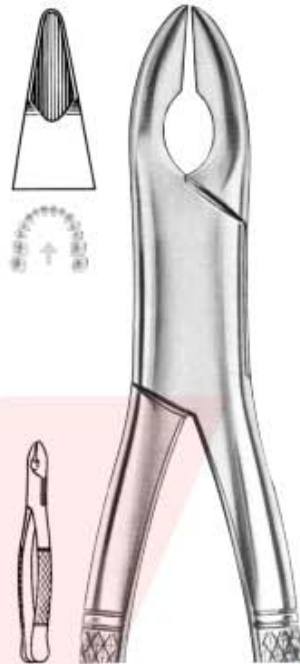

ID-12A-0010SN
10 S Nevius
 obere Eckzähne
 upper canines
 canines supérieures
 caninos superiores



ID-12A-0001AH
1 A Henahan
 obere Schneidezähne
 upper incisors
 incisives supérieures
 incisivos superiores



ID-12A-0010HN
10 H Nevius
 obere Eckzähne
 upper canines
 canines supérieures
 caninos superiores



ID-12A-0004S
4 Standard
 obere dritte Molaren
 upper third molars
 troisiemes molaires supérieures
 terceros molares superiores

EXTRACTING FORCEPS (American Pattern)



Extracting Forceps (American Pattern)
Zahnzangen (Amerikanische Form)

Daviers (Forme américaine)
Forceps de Extracción (Forme americana)

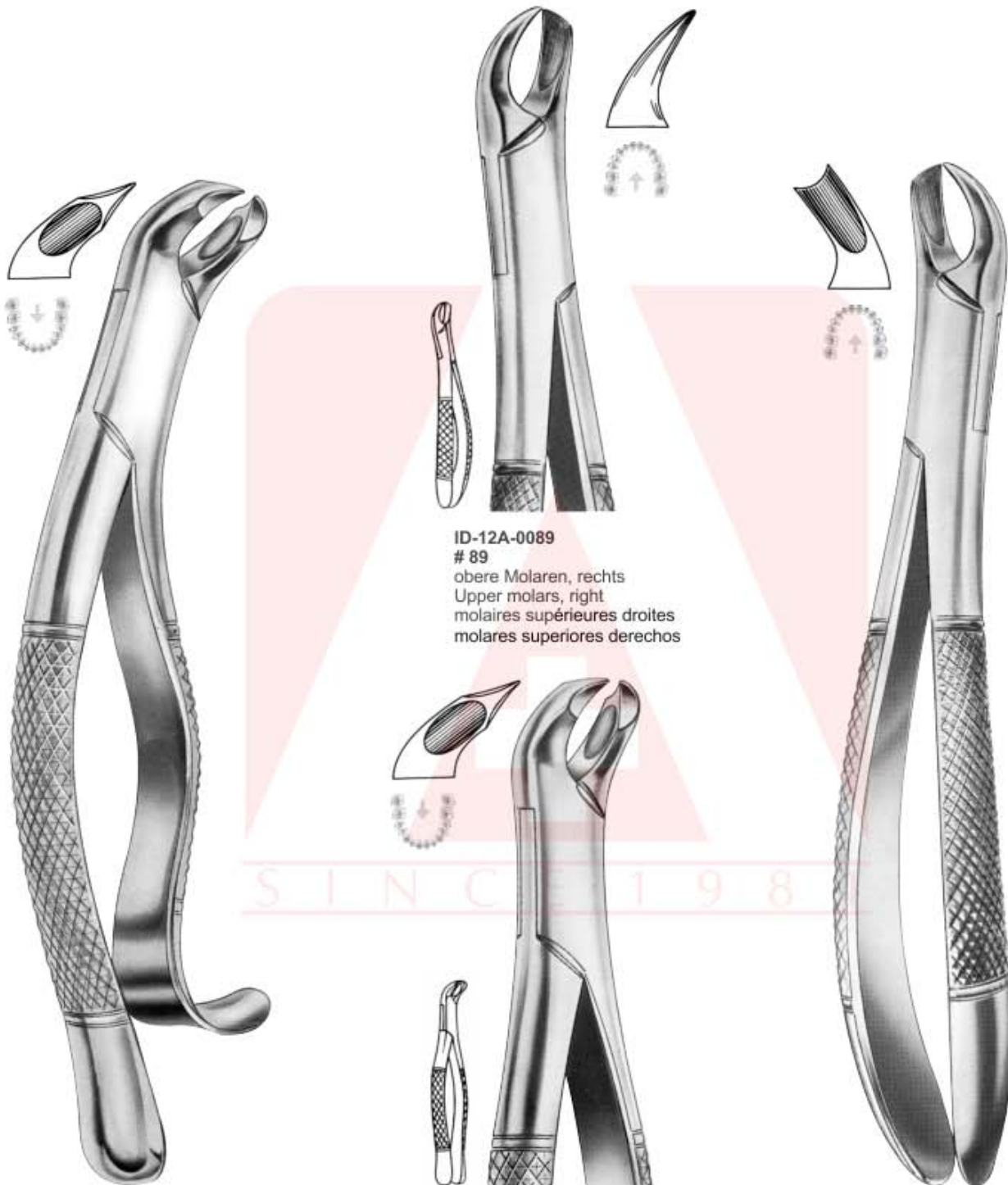

ID-12A-0089
89
obere Molaren, rechts
Upper molars, right
molaires supérieures droites
molares superiores derechos

ID-12A-00FH
FH Woodward
untere Molaren
Lower molars
molaires inférieures
molares inferiores

ID-12A-00FS
FS Woodward
untere Molaren
Lower molars
molaires inférieures
molares inferiores

ID-12A-0090
90
obere Molaren, links
Upper molars, left
molaires supérieures gauches
molares superiores izquierdos

EXTRACTING FORCEPS (American Pattern)



Extracting Forceps (American Pattern)
Zahnzangen (Amerikanische Form)

Daviers (Forme américaine)
Forceps de Extracción (Forme americana)



ID-12A-0023S
23 S
untere Molaren
Lower molars
molaires inférieures
molares inferiores



ID-12A-0017SK
17 SK
untere Molaren
Lower molars
molaires inférieures
molares inferiores



ID-12A-0150SK
150 SK
untere zähne und wurzeln
Upper anteriors and roots
dents et racines inférieures
dientes y raíces inferiores



ID-12A-0151SK
151 SK
obere zähne und Wurzeln
lower anteriors and roots
dents et racines supérieures
dientes y raíces superiores



Root Elevators

- English Pattern
- American Pattern





Root elevators
Wurzelheber

Élévateurs
Elevadores para raices



ID-14-0001
1
gerade/straight
droits/rectas

2.5mm



3.0mm



ID-14-0002
2
gerade/straight
droits/rectas

4.0mm



ID-14-0003
3
gerade/straight
droits/rectas

5.0mm



ID-14-0004
4
gerade/straight
droits/rectas



ID-14-0005
1
gebogen/curved
courbes/curvas

2.5mm



3.0mm



ID-14-0006
2
gebogen/curved
courbes/curvas

4.0mm



ID-14-0007
3
gebogen/curved
courbes/curvas

5.0mm



ID-14-0008
4
gebogen/curved
courbes/curvas



Root elevators
Wurzelheber

Elévateurs
Elevadores para raices



ID-14-0009
1
Bein 2mm



ID-14-0010
2
Bein 3mm



ID-14-0011
3
Bein 4mm



ID-14-0012
4
Bein 2,5mm



ID-14-0013
5
Bein 3mm



ID-14-0014
6
Bein 4mm



ID-14-0015
7
White



ID-14-0016
8
White



ID-14-0017
9
Berten

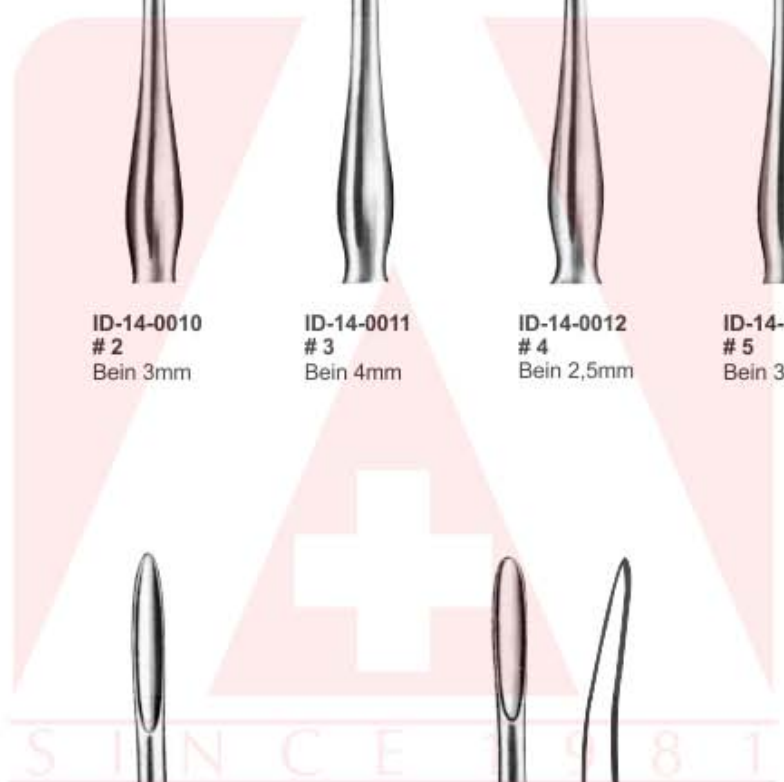



Root elevators
Wurzelheber

Élévateurs
Elevadores para raices



ID-14-0018
1



ID-14-0019
2



ID-14-0020
3



ID-14-0021
4



ID-14-0022
5



ID-14-0023
6



ID-14-0024
7



ID-14-0025
8



ID-14-0026
9



ID-14-0027
10



ID-14-0028
11



ID-14-0029
12

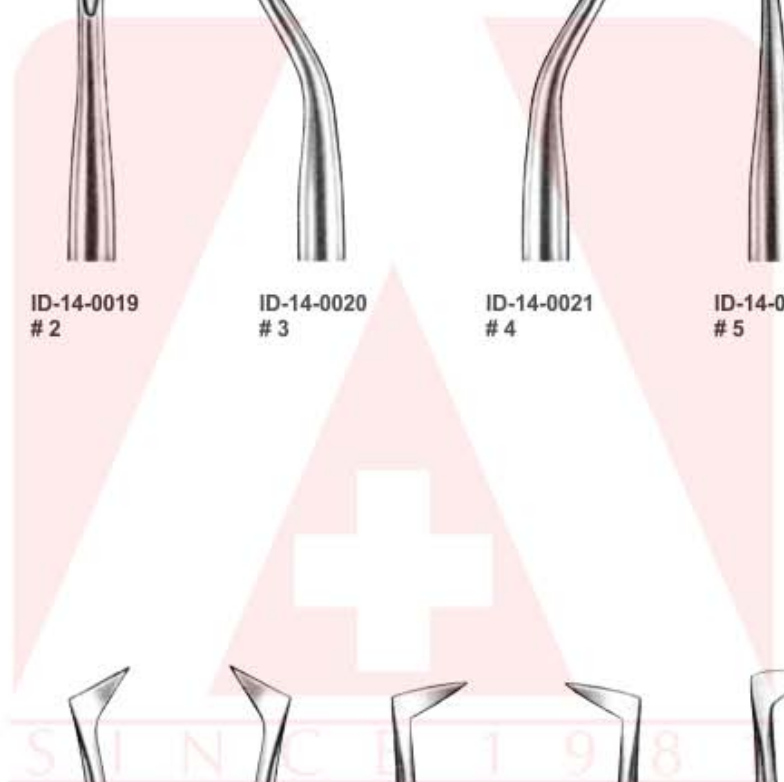



Root elevators
Wurzelheber

Élévateurs
Elevadores para raices



ID-14-0030
1



ID-14-0031
2
Flohr



ID-14-0032
3
Flohr



ID-14-0033
4
Flohr



ID-14-0034
5
Friedman



ID-14-0035
6
Friedman



ID-14-0036
7
Friedman



ID-14-0037
8
Heidbrink



ID-14-0038
9
Heidbrink



ID-14-0039
10
Heidbrink



ID-14-0040
11



ID-14-0041
12



ID-14-0042
13
Flohr



ID-14-0043
14



ID-14-0044
15



ID-14-0045
16



ID-14-0046
17



ID-14-0047
18



ID-14-0048
19
Lindo-Levien



Root elevators
Wurzelheber

Élévateurs
Elevadores para raices





Root elevators
Wurzelheber

Élévateurs
Elevadores para raices



ID-14-0062
2
Apical 302

ID-14-0063
3
Apical 303

ID-14-0064
4
Apical 304

ID-14-0065
5
12 A

ID-14-0066
6
34 S Seldin

ID-14-0067
7
34 Seldin

ID-14-0068
8

ID-14-0069
9
Flohr

ID-14-0070
10
Flohr

ID-14-0071
11
Flohr

ID-14-0072
12
3 Seldin

ID-14-0073
13

S I N C E 1 9 8 1

ID-14-0061
1
Apical 301

ID-14-0074
14
3 A Cryer

ID-14-0075
15
2 Seldin

ID-14-0076
16
12 Cryer

ID-14-0077
17
5 Seldin

ID-14-0078
18
Crane Pick

ID-14-0079
19



Root elevators
Wurzelheber

Élévateurs
Elevadores para raices



ID-14-0080
20
Flohr

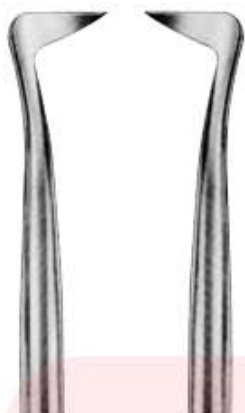

ID-14-0081
21
1 L Seldin



ID-14-0082
22
1 R Seldin



ID-14-0083
23
4 L Seldin



ID-14-0084
24
4 R Seldin



ID-14-0085
25



ID-14-0086
26



ID-14-0087
27
27 Cryer



ID-14-0088
28
28 Cryer



ID-14-0089
27
27 S Cryer



ID-14-0090
28
28 S Cryer



ID-14-0091
29
(344)



ID-14-0092
30
(345)



ID-14-0093
31



ID-14-0094
32



ID-14-0095
33
Miller 1



ID-14-0096
34
Miller 2



ID-14-0097
35
Miller 3



ID-14-0098
36
Miller 4



Root elevators
Wurzelheber

Élévateurs
Elevadores para raices



ID-14-0100
2
Apical 302



ID-14-0101
3
Apical 303



ID-14-0102
4
Apical 304



ID-14-0103
5
12 A



ID-14-0104
6
34 S Seldin



ID-14-0105
7
34 Seldin



ID-14-0099
1
Apical 301



ID-14-0106
8



ID-14-0107
9
Flohr



ID-14-0108
10
Flohr



ID-14-0109
11
Flohr



ID-14-0110
12
3 Seldin



ID-14-0111
13

S I N C E 1 9 8 1



ID-14-0112
14
3 A Cryer



ID-14-0113
15
2 Seldin



ID-14-0114
16
12 Cryer



ID-14-0115
17
5 Seldin



ID-14-0116
18
Crane Pick



ID-14-0117
19



Root elevators
Wurzelheber

Élévateurs
Elevadores para raices



ID-14-0119
21
1 L Seldin



ID-14-0120
22
1 R Seldin



ID-14-0121
23
4 L Seldin



ID-14-0122
24
4 R Seldin



ID-14-0123
25



ID-14-0124
26



ID-14-0125
27
27 Cryer



ID-14-0126
28
28 Cryer



ID-14-0127
27
27 S Cryer



ID-14-0128
28
28 S Cryer



ID-14-0129
29
(344)



ID-14-0130
30
(345)



ID-14-0131
31



ID-14-0132
32



ID-14-0133
33
Miller 1



ID-14-0134
34
Miller 2



ID-14-0135
35
Miller 3



ID-14-0136
36
Miller 4



ID-14-0118
20
Flohr

S I N C E 1 9 8 1



Root elevators
Wurzelheber

Élévateurs
Elevadores para raíces



Hyllin



ID-14-0137
1
Hyllin
4,5mm



ID-14-0138
2
Hyllin
3mm



ID-14-0139
3
Hyllin
3mm



ID-14-0140
4
Hyllin
3mm

2,5mm

3,5mm

4,5mm



ID-14-0141
1



ID-14-0142
2
Lindo-Levien



ID-14-0143
3



Root elevators
Wurzelheber

Élévateurs
Elevadores para raices



ID-14-0144
FLOHR

ID-14-0145
FLOHR

ID-14-0146
BEIN

ID-14-0147
BEIN

ID-14-0148
BEIN

ID-14-0149
BEIN



Root elevators
Wurzelheber

Élévateurs
Elevadores para raices

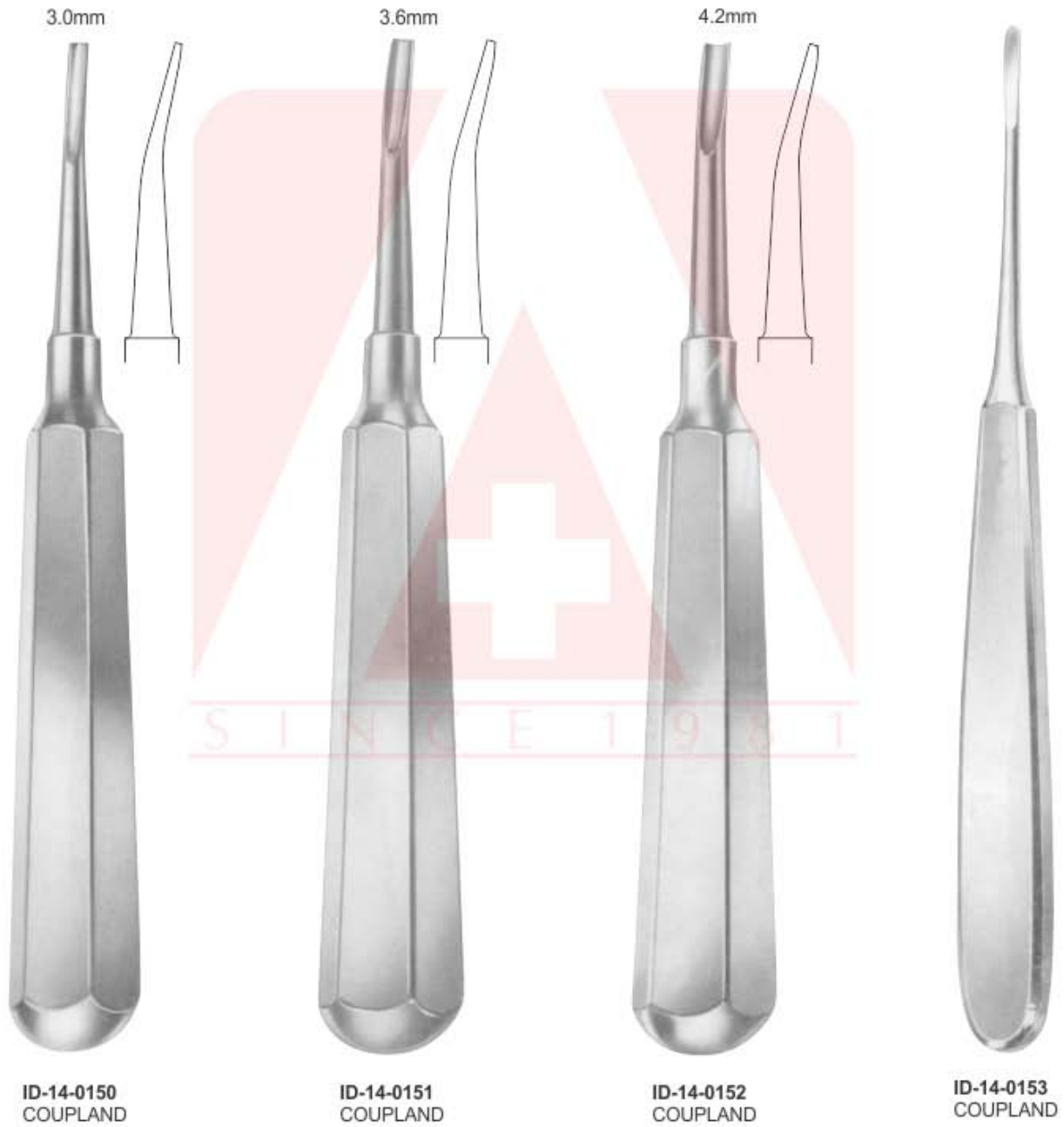



Root elevators
Wurzelheber

Elévateurs
Elevadores para raices



ID-14-0154
CRYER-WHITE

ID-14-0155
CRYER-WHITE

ID-14-0156
WHITE

ID-14-0157
WHITE

ID-14-0158
SELDIN



Root elevators
Wurzelheber

Élévateurs
Elevadores para raices



ID-14-0159
OSSEOUS CHISELS
COUPLAND



ID-14-0160



ID-14-0161



ID-14-0162
CRYER



ID-14-0163
CRYER



ID-14-0164
WARWICK-JAMES



ID-14-0165



ID-14-0166



Root elevators
Wurzelheber

Elévateurs
Elevadores para raices



ID-14-0167
Heidbrink



ID-14-0168
Heidbrink



ID-14-0169
Heidbrink



ID-14-0170
FLOHR



ID-14-0171
FLOHR



Root elevators
Wurzelheber

Elévateurs
Elevadores para raices

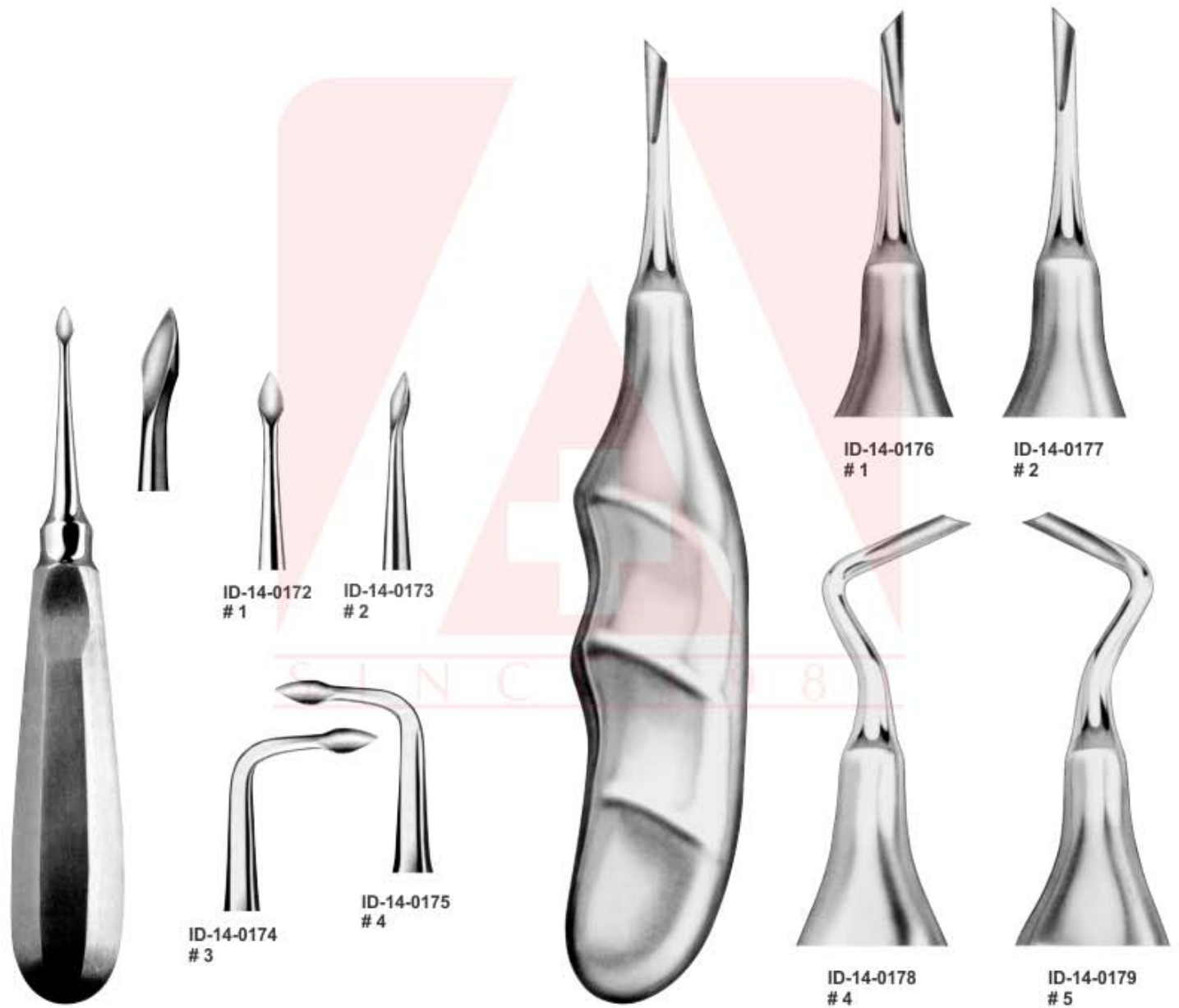



Root elevators
Wurzelheber

Élévateurs
Elevadores para raices



Kopp
ID-14-0180
1



ID-14-0181
2



ID-14-0182
3
Kopp



ID-14-0183
4



ID-14-0184
Berten



ID-14-0185
Berten

S I N C E 1 9 8 1



Root elevators
Wurzelheber

Elévateurs
Elevadores para raices



Thomson



ID-14-0186
1
Thomson



ID-14-0187
2
Thomson



ID-14-0188
3
Thomson



ID-14-0189
4
Thomson



ID-14-0190
5
Thomson



ID-14-0191
6
Thomson



ID-14-0192
1
Schlemmer



ID-14-0193
2
Schlemmer



ID-14-0194
3
Schlemmer



Root elevators
Wurzelheber

Élévateurs
Elevadores para raices



ID-14-0195
1



ID-14-0196
2



ID-14-0197
3

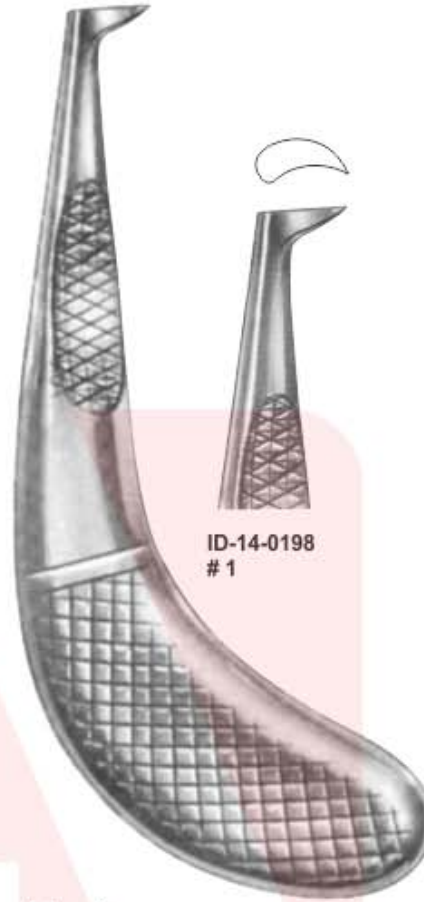

ID-14-0198
1



ID-14-0199
2



ID-14-0200
1
Lecluse

ID-14-0201
2
Lecluse

Lecluse



Root elevators
Wurzelheber

Élévateurs
Elevadores para raices



ID-14-0202
1
Winter
1 L



ID-14-0203
2
Winter
1 R



ID-14-0204
3
Winter
11 L



ID-14-0205
4
Winter
11 R



ID-14-0206
5
Winter
12 L



ID-14-0207
6
Winter
12 R



ID-14-0208
7
Winter
13 L



ID-14-0209
8
Winter
13 R



ID-14-0210
9
Winter
14 L



ID-14-0211
10
Winter
14 R



ID-14-0212
11
Mead 1



ID-14-0213
12
Mead 2



ID-14-0214
13
Mead 3



ID-14-0215
14
Mead 4



ID-14-0216
15
Mead 9 A



ID-14-0217
16
Mead 10 A



ID-14-0218
17
Mead 11

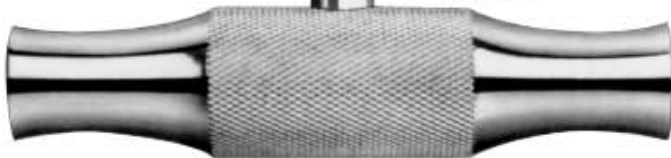

Winter



Root elevators
Wurzelheber

Élévateurs
Elevadores para raices



ID-14-0219 # 1
Barry 320

ID-14-0220 # 2
Barry 321

ID-14-0221 # 3
Barry 322

ID-14-0222 # 4
Barry 323



ID-14-0223 # 5
Barry 350

ID-14-0224 # 6
Barry 351

ID-14-0225 # 7
Barry 370

ID-14-0226 # 8
Barry 371

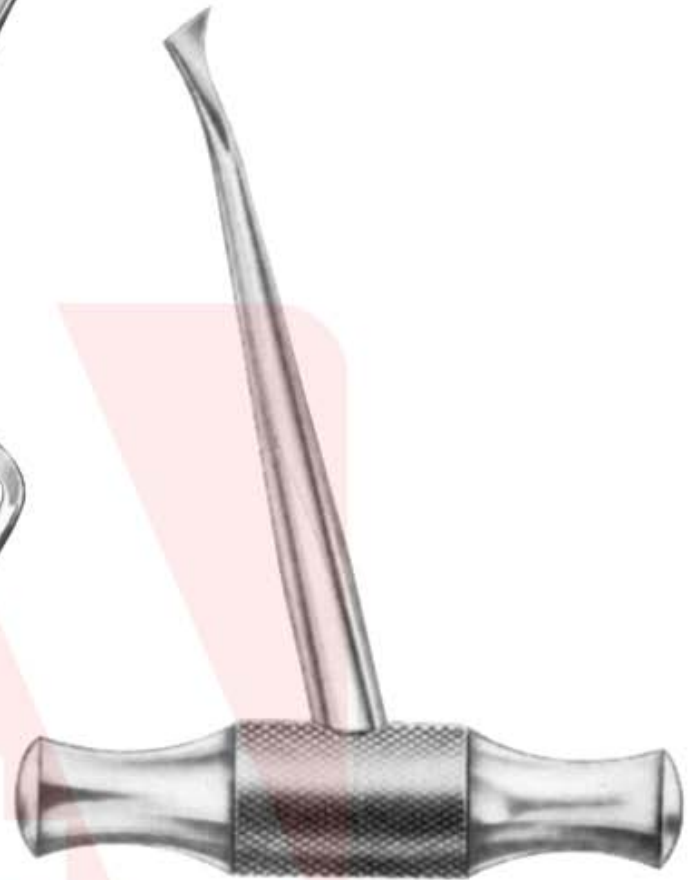

Barry 320



ID-14-0227 # 1



ID-14-0228 # 3



ID-14-0229 # 4



ID-14-0230 # 2

S I N C E 1 9 8 1



Apical Fragment Ejectors
Wurzelrestentferner

Élévateurs a fragments
Botadores para fragmentos

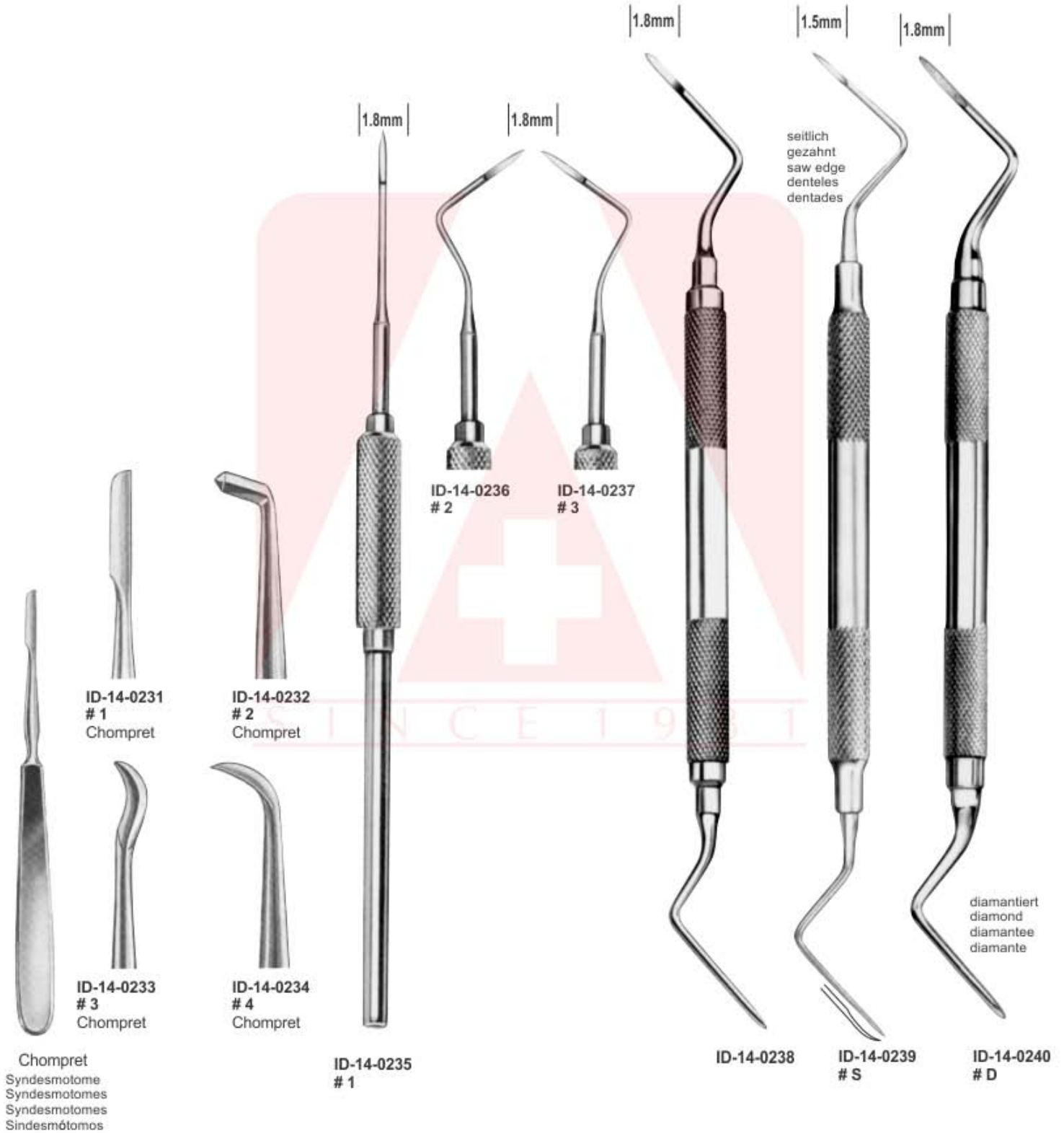



Apical Fragment Ejectors
Wurzelrestentferner

Élévateurs a fragments
Botadores para fragmentos

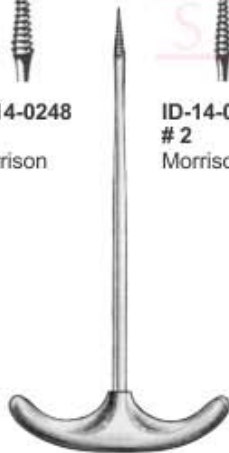
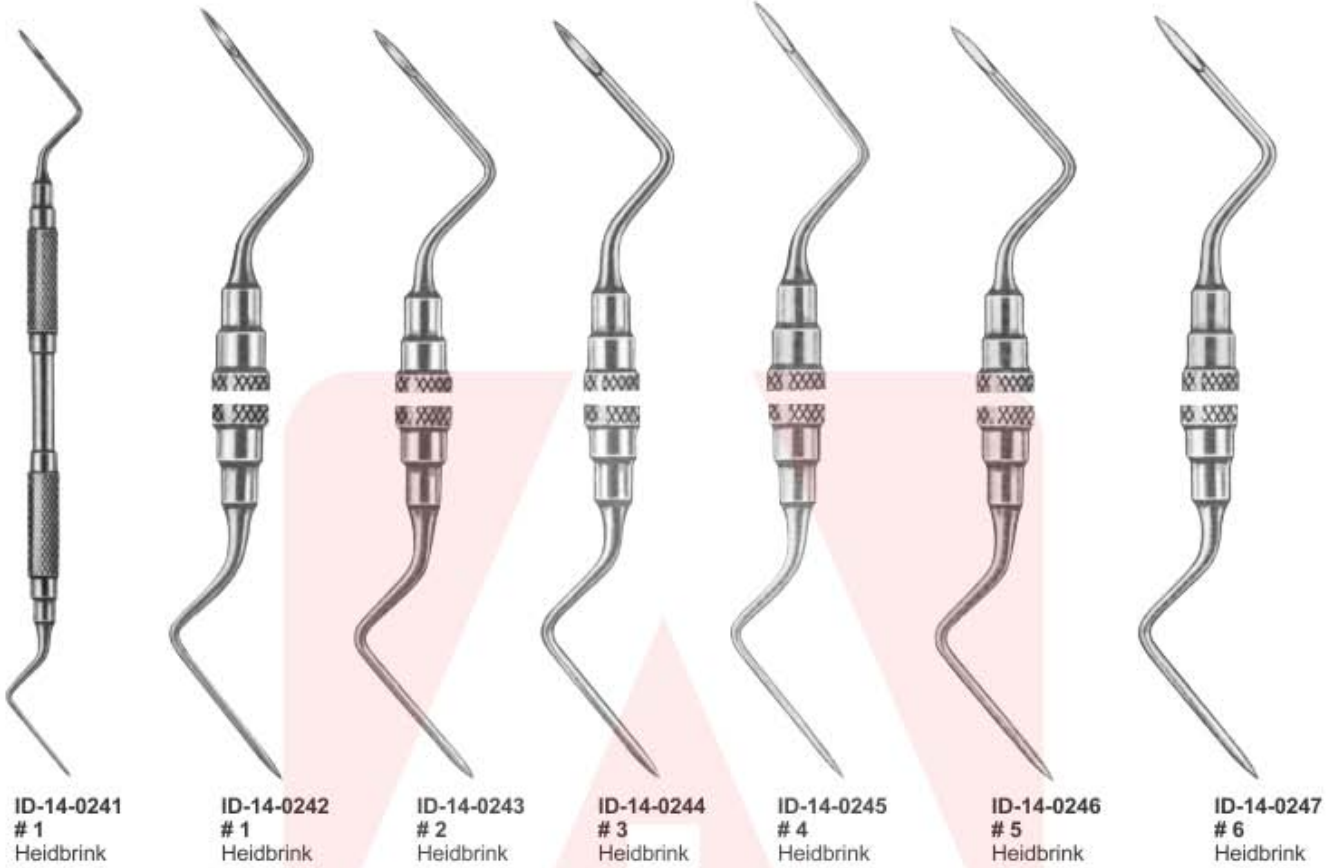

Morrison
Wurzelschrauben
Root Screws
Vis à racines
Tornillos para raíces





Scalers, Probes & Spatulas

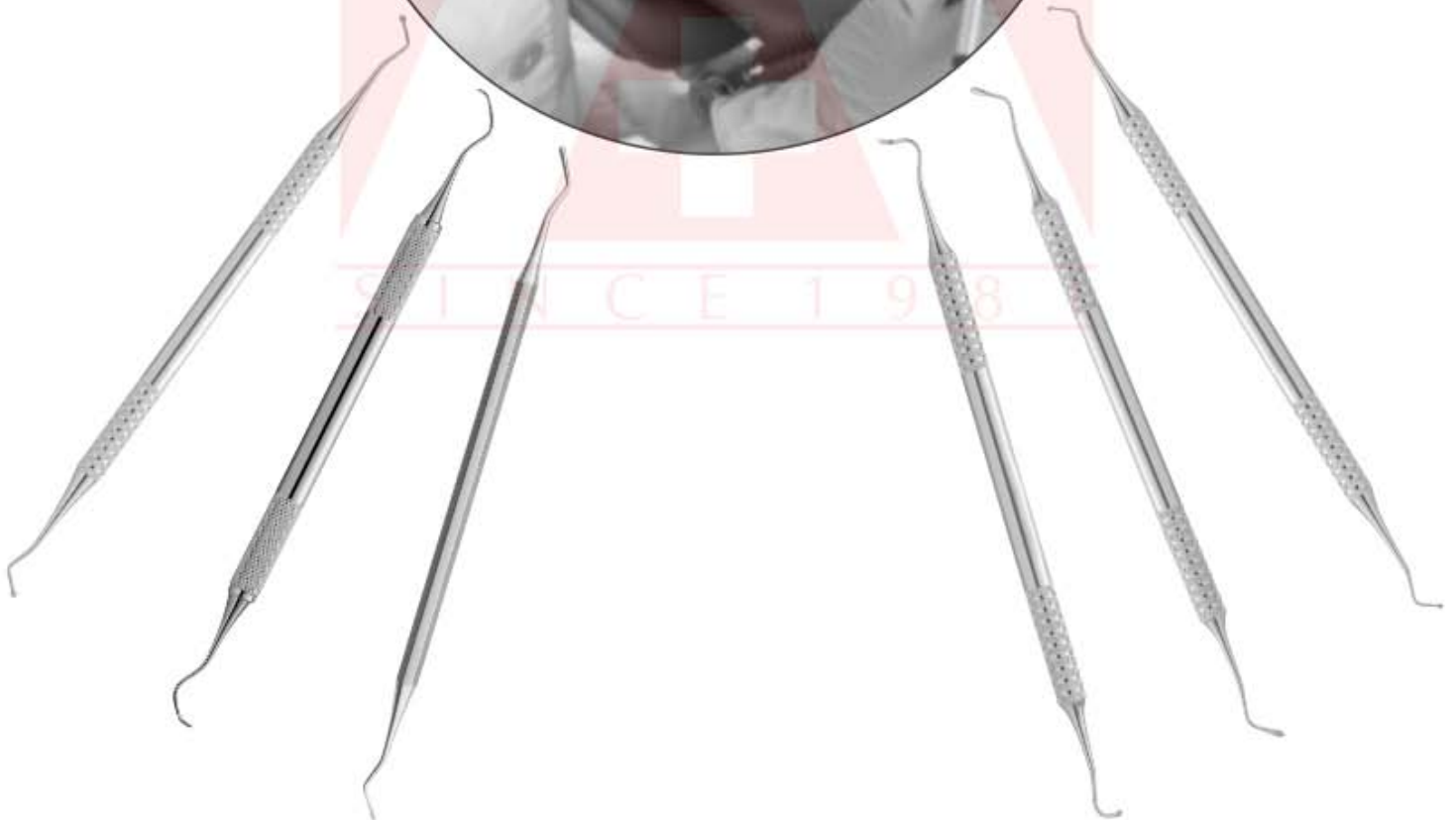



Calibrated Probes
Tasxhenmeßsonden

Sondas Calibradas
Sondes Graduées

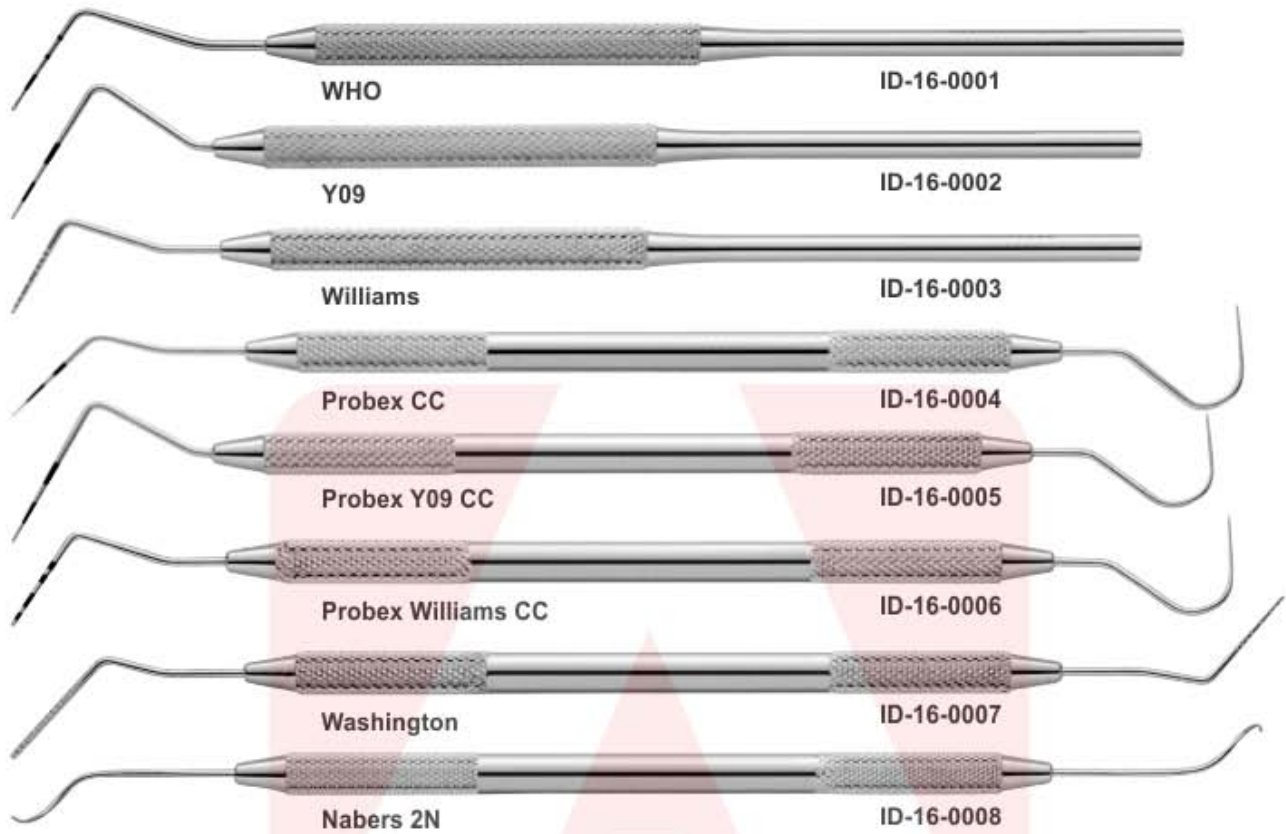

Probes Single End





Calibrated Probes
Tasxhenmeßsonden

Sondas Calibradas
Sondes Graduées

Probes-double End

Long lasting, easy-to-read, color coded, metal probes



Explorers



Scalers
Zahnreiniger

Instruments à détartrer
Limpiadores de sarro

Mccalls



Mccalls 13/14

ID-16-0027



Mccalls 13S/14S

ID-16-0028



Mccalls 17/18

ID-16-0029



Mccalls 17S/18S

ID-16-0030

Columbia



Columbia 2L/2R

ID-16-0031



Columbia 4L/4R

ID-16-0032



Columbia 13/14

ID-16-0033

Jacquette



Jacquette 34/35

ID-16-0034



Jacquette 1/1S

ID-16-0035



Jacquette 2S/3S

ID-16-0036



*Excavators
Excavatoren*

*Excavadores
Excavateurs*

Root Canal Excavators

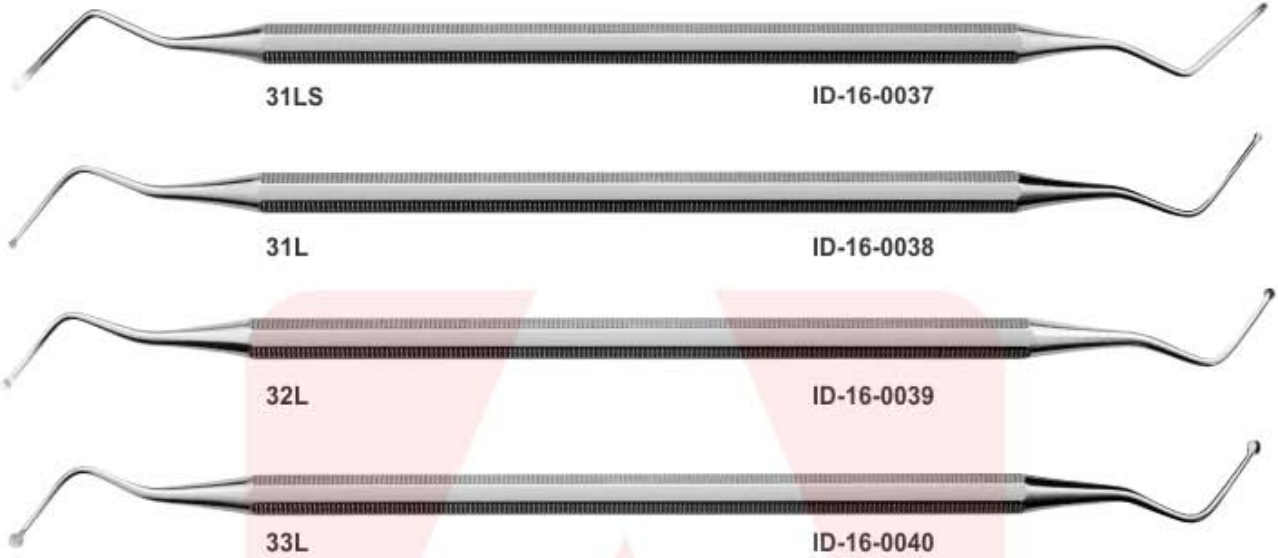

Root Canal



Root Canal Spreaders-stainless Steel





*Spreaders
Spreizer*

*Extbsires
Ecarteurs*

Root Canal Spreaders



Endodontic Spreaders

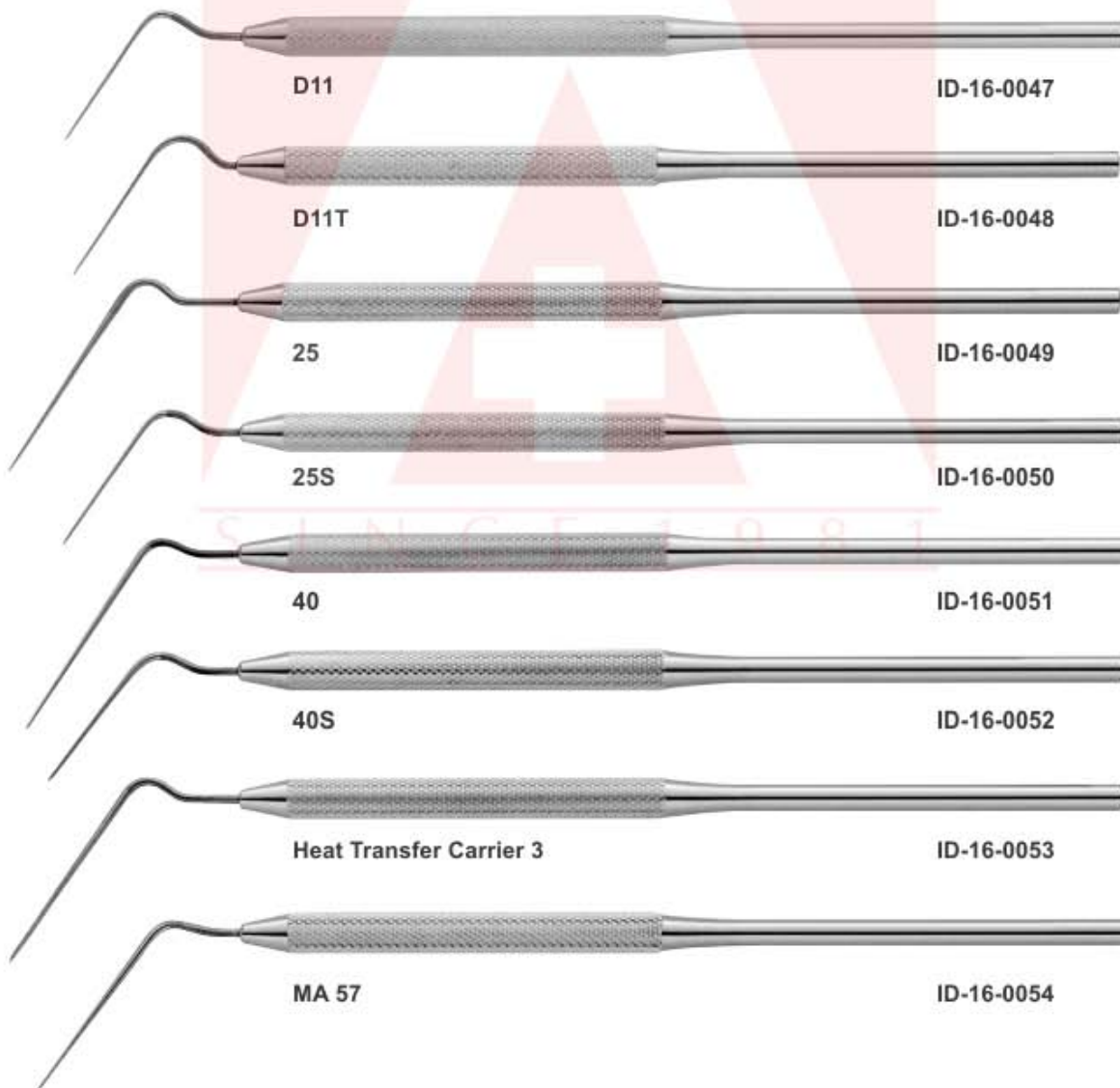



Prober & Explorers
Zahnsonden

Sondas y Exploradores
Sondas et Explorateurs

Root Canal Pluggers

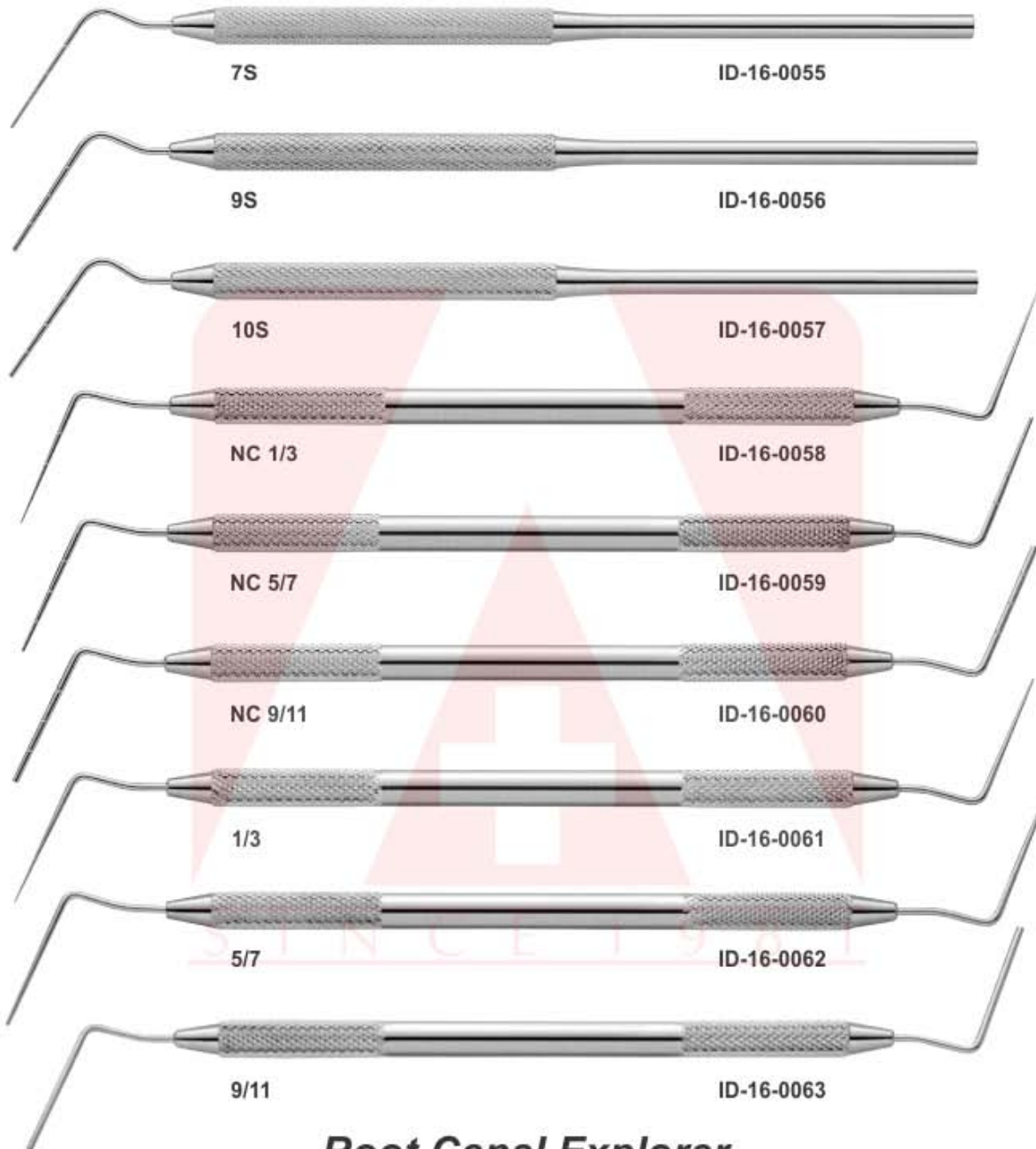

Root Canal Explorer





Gracey-Curettes
Gracey-Küretten

Gracey-curetas
Gracey-curttes



ID-16-0066
Gracey 1/2-short shank for
incisors and cuspids



ID-16-0067
Gracey 3/4-short contra-angle shank for
incisors and cuspids



ID-16-0068
Gracey 5/6-medium shank for
cuspids and molars



ID-16-0069
Gracey 7/8-medium contra-angle shank for
bicuspids and molars, buccal and lingual surfaces



ID-16-0070
Gracey 9/10-long contra-angled for molars
with more acute blade angle



ID-16-0071
Gracey 11/12*-triple angulation for easy access to mesio-buccal
and mesial-lingual surfaces of bicuspids and molars



ID-16-0072
Gracey 11/12*-triple angulation for easy access to
disto-posterior surfaces of bicuspids and molars



ID-16-0073
Gracey 15/16-Angled shank, designed to reach
mesial surfaces of posterior teeth



ID-16-0074
Gracey 15/16-Highly angled shank for reaching
distal surfaces of posterior teeth



Universal Curettes
Universal-Küretten

Curetas uncersales
Curettes unverselles

204 Series

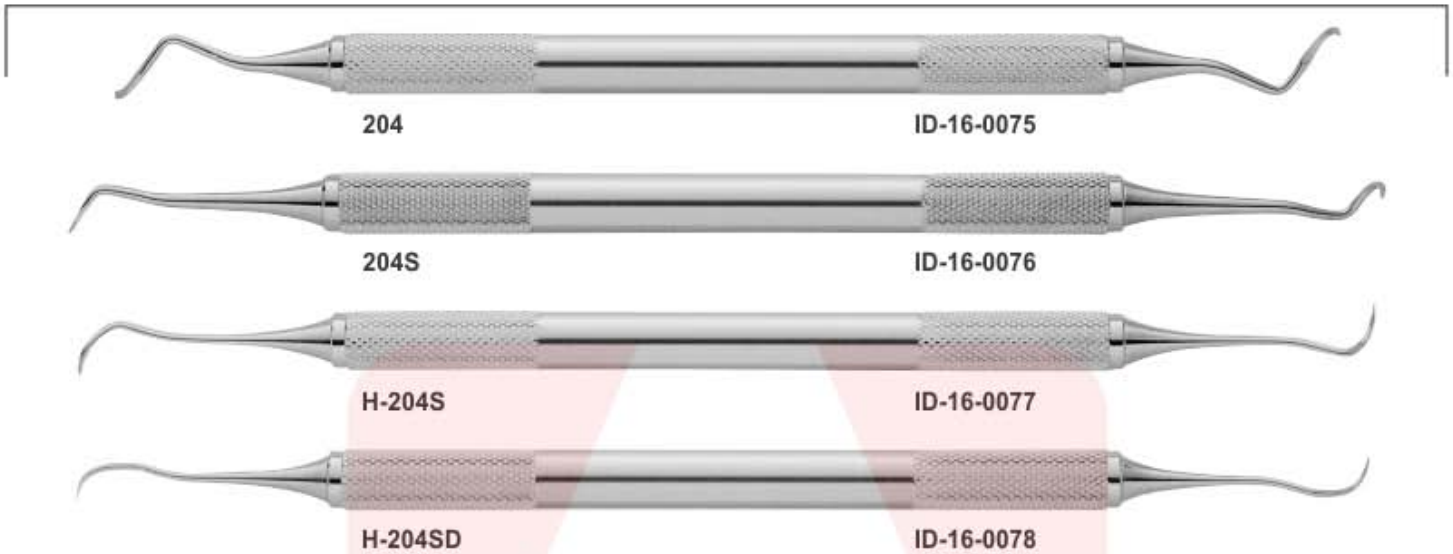

Sickles

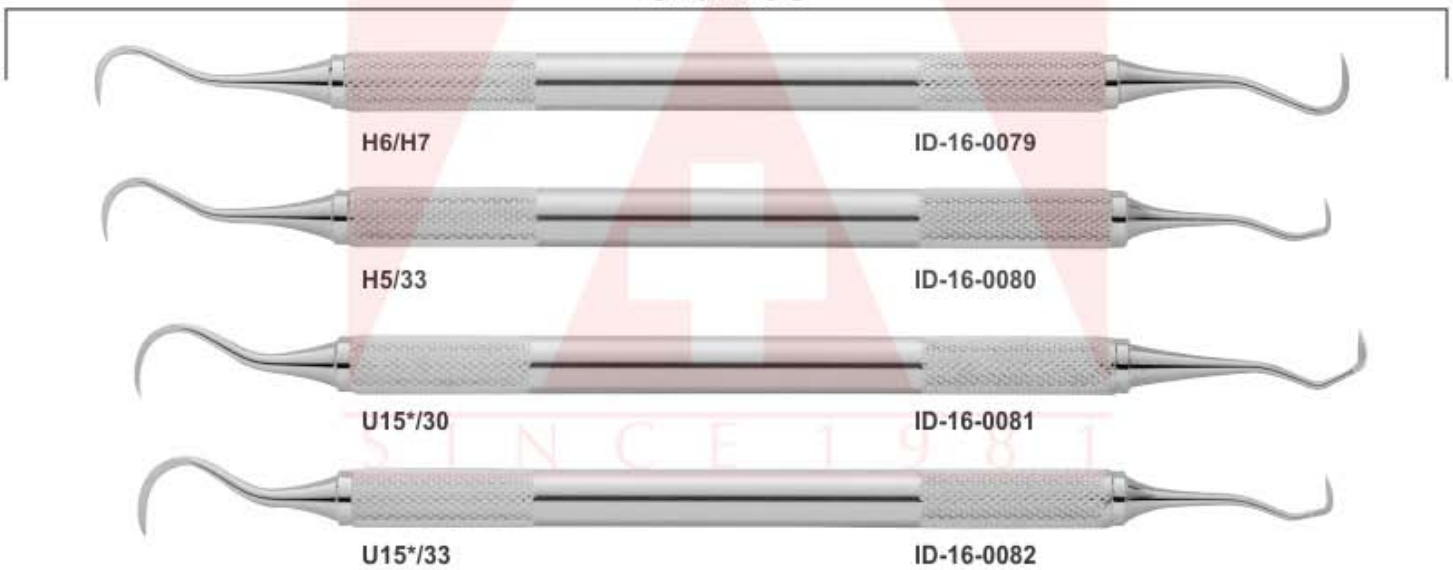

Barnhart



Filling Instruments
Füllungsinstrumente

Instruments pour plombage
Instrumentos para obturaciones

Burnishers-double End





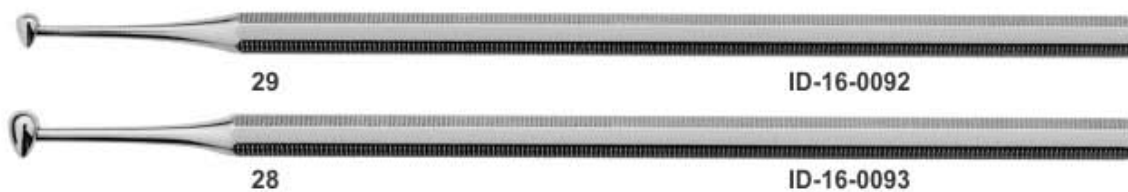









Burnishers-single End





Black's Cutting Instruments
Schneidende instrmente nach black

Instrumentos cortantes de black
Instruments tranchants de black









	Shooshan A	ID-16-0094
	Bredall 4	ID-16-0095
	21	ID-16-0096
	21B	ID-16-0097
	Frahm H/H	ID-16-0098
	Hollenback 3	ID-16-0099
	Hollenback 3S	ID-16-0100
	Walls 3	ID-16-0101
	Ward 1	ID-16-0102
	Ward 2	ID-16-0103
	Caulk 5/7	ID-16-0104
	Levy 7	ID-16-0105









Plastic Filling Instruments & Excavators
Instrumente für plastische füllungen, Excavatoren

Instrumentos para obturaciones plásticas, Excavadores
Instruments pour plombages plastiques, Excavateurs

Plastic Filling

	13	ID-16-0106
	IPP-A	ID-16-0107
	D2	ID-16-0108
	D3	ID-16-0109
	Gregg 2/3	ID-16-0110
	Gregg 4/5	ID-16-0111
	Ladmore 2	ID-16-0112
	Ladmore 3	ID-16-0113
	CJ	ID-16-0114

Excavators

	12 (C17)	ID-16-0115
	13 (C18)	ID-16-0116
	14 (C19)	ID-16-0117
	15 (C20)	ID-16-0118
	16 (C21)	ID-16-0119
	17 (C22)	ID-16-0120











Plastic Filling Instruments
Instrumente für plastische füllungen

Instrumentos para obturaciones plásticas
Instrumentos pour plombages plastiques



Wax And Modelling Carvers
Wachs-und modellierinstrumente

Instruments á cire et á modeler
Talladores para cera y para modelar

	Black 89/92	ID-16-0130
	Cleoid/Discoïd	ID-16-0131
	3/6	ID-16-0132
	5C	ID-16-0133
	6C	ID-16-0134
	7C	ID-16-0135
	3T	ID-16-0136
	IPC Interproximal	ID-16-0137
	IPC-A (Angled)	ID-16-0138
	4T	ID-16-0139
	5T	ID-16-0140



Filling Instruments
Füllungsinstrumente

Instruments pour plombage
Instrumentos para obturaciones



Sherman Packer Smooth, Serrated

ID-16-0141



Balshi Packer Smooth, Serrated

ID-16-0142



Balshi Packer Angled

ID-16-0143



Round Angled Smooth, Serrated

ID-16-0144



Round Straight Smooth, Serrated

ID-16-0145



Taper Angled Smooth, Serrated

ID-16-0146



Taper Straight Smooth, Serrated

ID-16-0147

Pluggers / Condensers

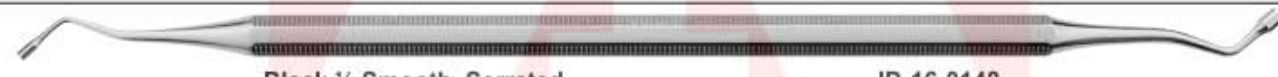

Black 1/2 Smooth, Serrated

ID-16-0148



Hollenback 1 Smooth, Serrated

ID-16-0149

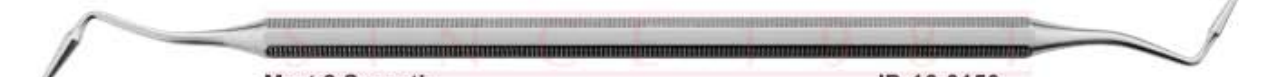

Mort 2 Smooth

ID-16-0150



Smith Smooth, Serrated

ID-16-0151



Detroit 1 Smooth

ID-16-0152



Ward 1 Smooth

ID-16-0153



Ward 2 Smooth

ID-16-0154



Ward 3 Smooth

ID-16-0155



Mixing Spatula
Anmischspatel

Spatule à Malaxer
Espatula para mezclar



Wax 7A
ID-16-0156

Wax 7
ID-16-0157

CMI 24
ID-16-0158

36
ID-16-0159

24
ID-16-0160

24A
ID-16-0161

22
ID-16-0162



Oral & Maxillo-facial Surgery Instruments





Cotton Pliers - Tweezers, Mouth Mirror & Mirror Handles
 Zahnpinzetten, Mundspiegel Mundspiegelgriffe

Précelles - Brucelles, Miroirs à bouche — Manches pour miroirs à bouche
 Pinzas para algodón, espejos de boca — Mangos para espejos de boca



ID-18-0001
Mirror



ID-18-0002
Solid stainless

A TYPE



ID-18-0003
Hollow Stainless

B TYPE



ID-18-0004
Cone Socket

C TYPE



ID-18-0005
Simple Stem

D TYPE



20 mm
Diameter

ID-18-0006
Mouth Mirror Rhodium



22 mm
Diameter

ID-18-0007
Mouth Mirror Rhodium



24 mm
Diameter

ID-18-0008
Mouth Mirror Rhodium



ID-18-0009
Perry



ID-18-0010
Locking



ID-18-0011
Endodontic



ID-18-0012
College

S I C E 1 8 1



Cotton Pliers - Tweezers
Zahnpinzetten

Précelles - Brucelles
Pinzas para algodón

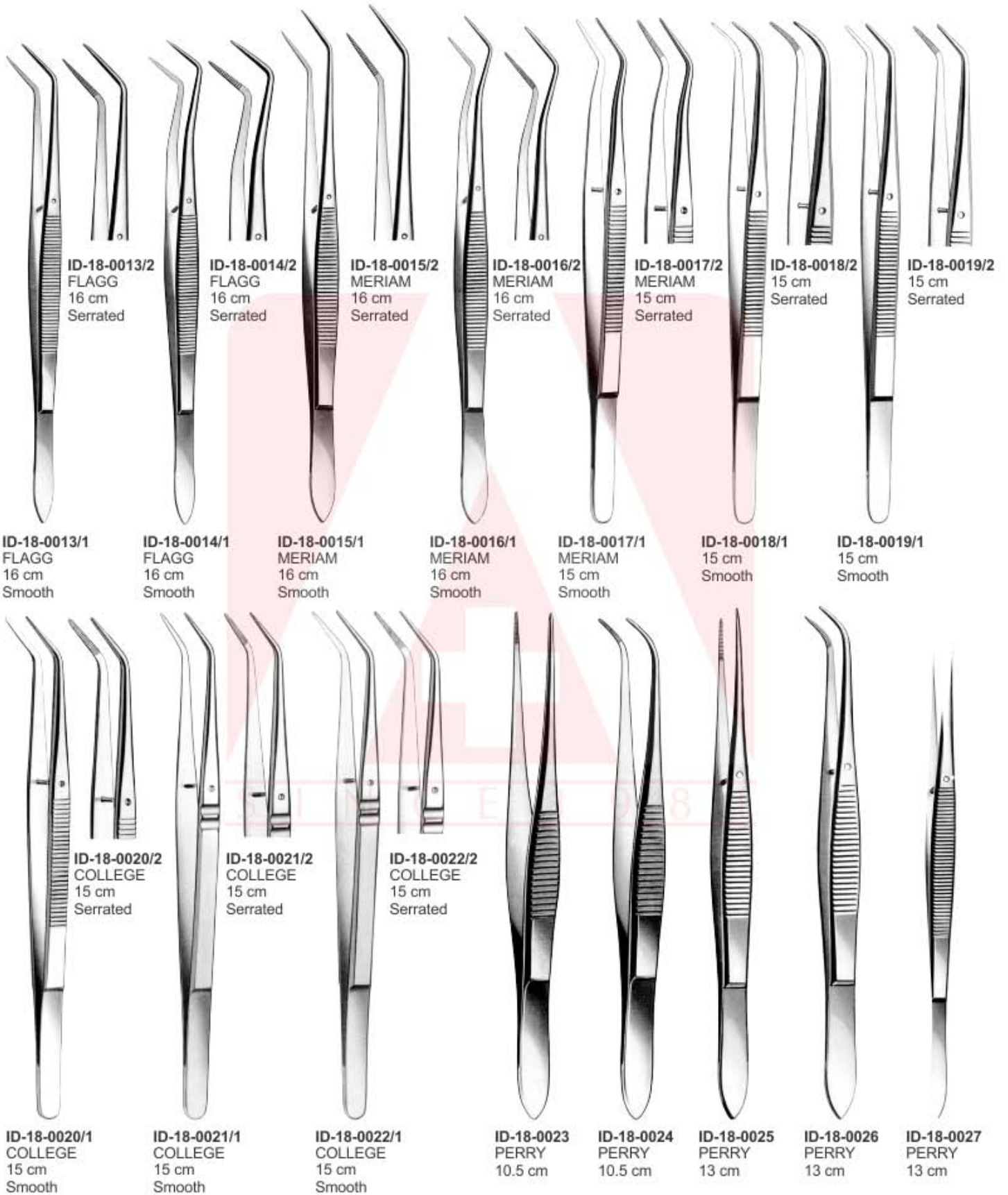



Cotton Pliers - Tweezers
Zahnpinzetten

Précelles - Brucelles
Pinzas para algodón



ID-18-0028



ID-18-0029



ID-18-0030



ID-18-0031



ID-18-0032



ID-18-0033



ID-18-0034



ID-18-0035

SOLDERING TWEEZERS & FORCEPS



ID-18-0036
16 cm



ID-18-0037
16 cm



Posigrip Articulating
Paper Forceps
ID-18-0038
15 cm



3/4"



Standard Articulating
Paper Forceps, Economy Grade
ID-18-0039
15 cm



3/4"

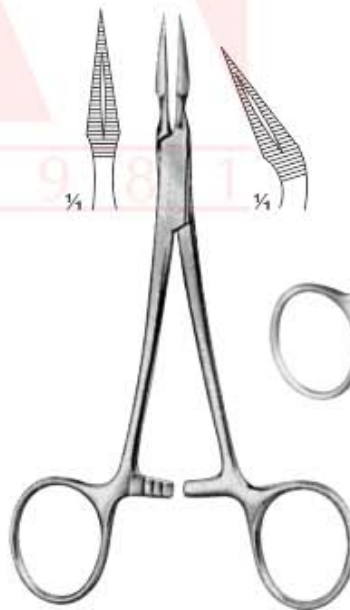

3/4"

3/4"

STIEGLITZ
ID-18-0040 14 cm, 5 1/2" Str.
ID-18-0041 14 cm, 5 1/2" Cvd.

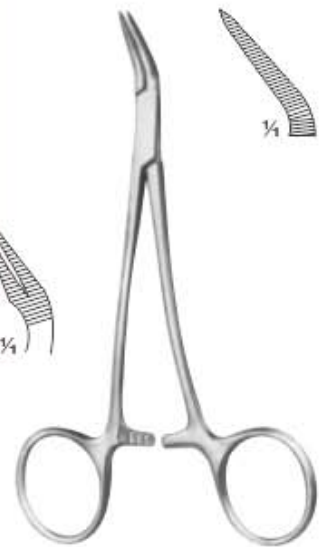

3/4"

PEET
ID-18-0042
11.5 cm, 4 1/2"

Operating Scissors
Chirurgische Scheren

Ciseaux à chirurgie
Tijeras para cirugía



ID-18-0043
Surgical Scissors
curve 13 cm

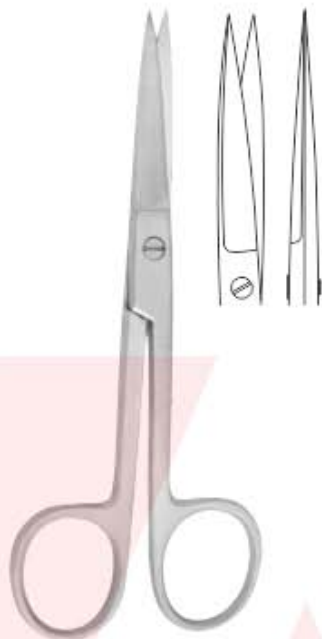

ID-18-0044
Surgical Scissors
Straight 13 cm



ID-18-0045
Goldman Fox (Serrated)
Curve 13 cm



ID-18-0046
Goldman Fox (Serrated)
Straight 13 cm



ID-18-0047
Iris Scissors
Curve 12 cm



ID-18-0048
Iris Scissors
Straight 12 cm



ID-18-0049
Scissors Castroviejo
Curve 11 cm



ID-18-0050
Scissors Castroviejo
Straight 11 cm



Operating Scissors
Chirurgische Scheren

Ciseaux à chirurgie
Tijeras para cirugía



ID-18-0051
Mayo Scissors
curve 14 cm

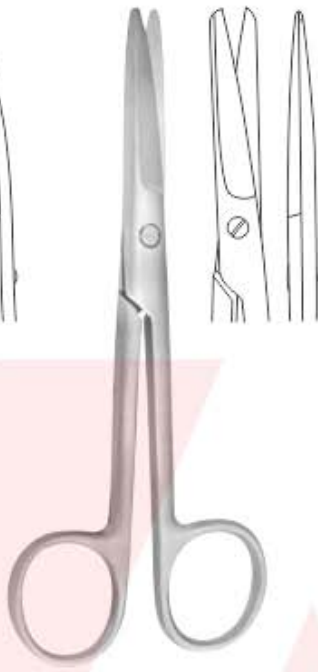

ID-18-0052
Mayo Scissors
Straight 14 cm



ID-18-0053
Crown Scissors
(Plain) Curve 12 cm



ID-18-0054
Crown Scissors
(Plain) straight 12 cm



ID-18-0055
Crown Scissors
(Serrated) Curve 12 cm

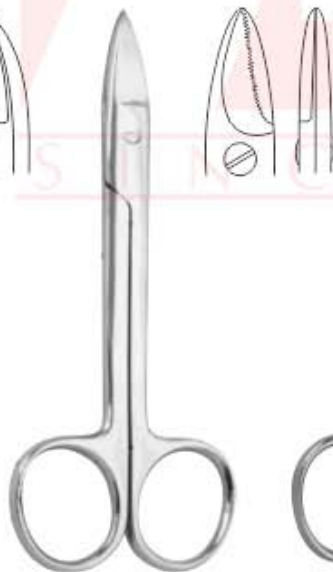

ID-18-0056
Crown Scissors
(Serrated) Straight 12 cm

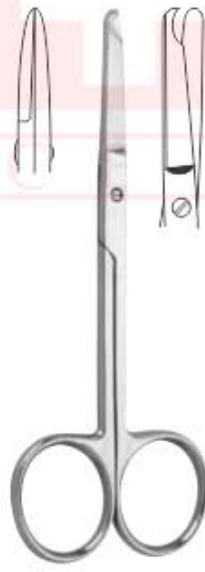

ID-18-0057
Suture Scissors
11.5 cm

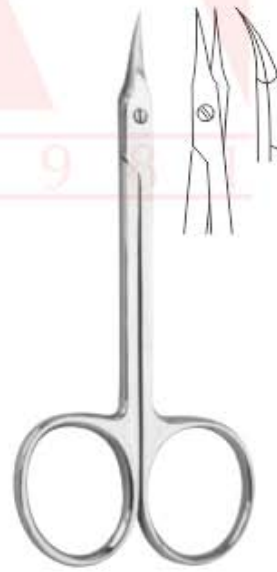

ID-18-0058
Fine Iris Scissors
Curve 12 cm



ID-18-0059
Fine Iris Scissors
Straight 12 cm



Gum Scissors
Zahnfleischscheren

Ciseaux à gencives
tijeras para encías



ID-18-0060
11cm



ID-18-0061
11cm



ID-18-0062
11cm



ID-18-0063
11cm



ID-18-0064
11cm

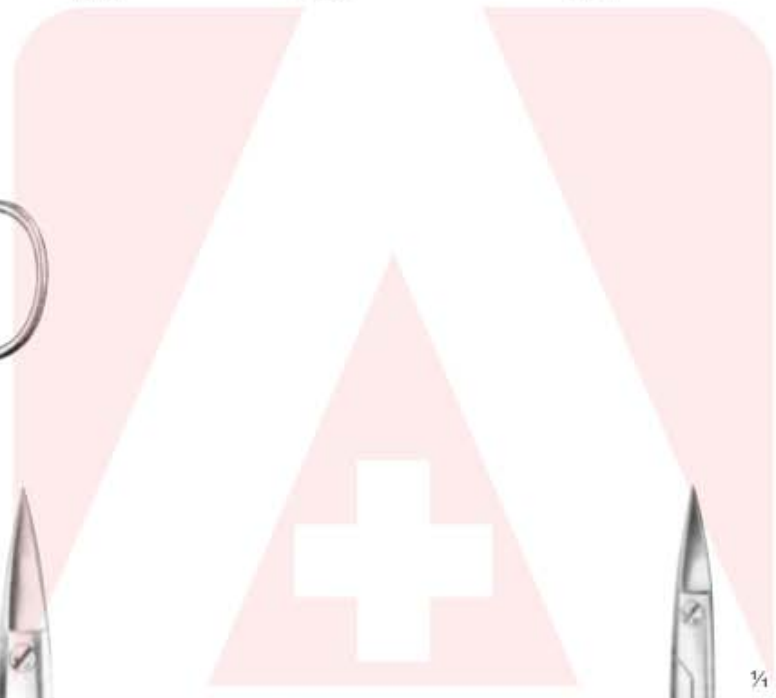

ID-18-0065
Quinby 12.5 cm



ID-18-0066
Quinby 12.5 cm



Arterienklemmen
Pinzas hemostaticas

Pinces hemostatiques
Pinze emostatiche



ID-18-0067
Halsted Mosquito
Curve 12 cm



ID-18-0068
Halsted Mosquito Baby
Curve 12 cm



ID-18-0069
Kelly Forceps
Curve 14 cm



ID-18-0070
Halsted Mosquito
Straight 12.5 cm



ID-18-0071
Halsted Mosquito Baby
Straight 10.5 cm



ID-18-0072
Kelly Forceps
Straight 14 cm





Hemostatic Forceps
Arterienklemmen

Pinces Hémostatiques
Pinzas Hemostáticas



ID-18-0073
Allison Tissue Forceps
(4 x 5) 15.5 cm

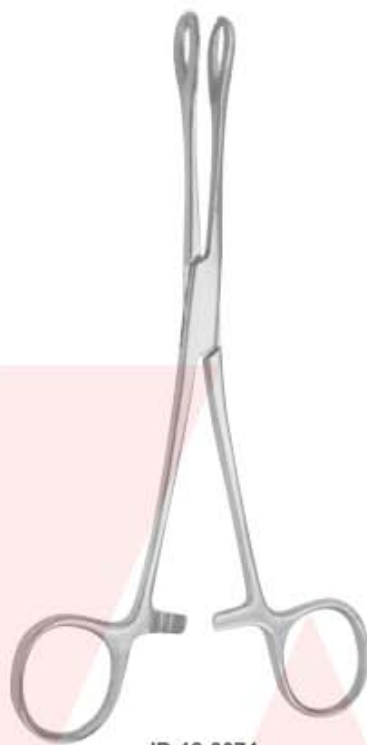

ID-18-0074
Anillos Forceps
18 cm

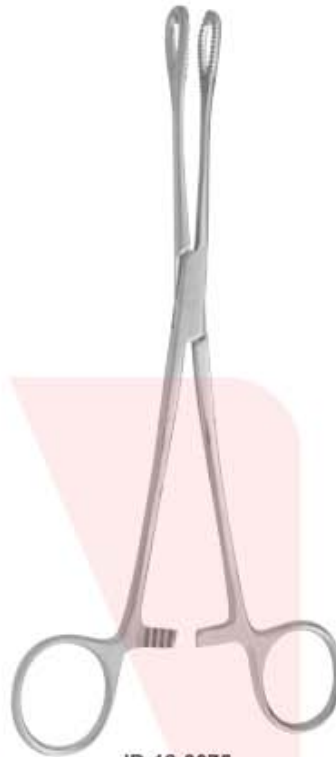

ID-18-0075
Anillos Forceps
21 cm



ID-18-0076
Sterilizing Forceps
40 cm



ID-18-0077
Backhaus
Towel Clamp
13.5 cm



ID-18-0078
Backhaus
Towel Clamp
8 cm



ID-18-0079
Rochester Forceps
14 cm

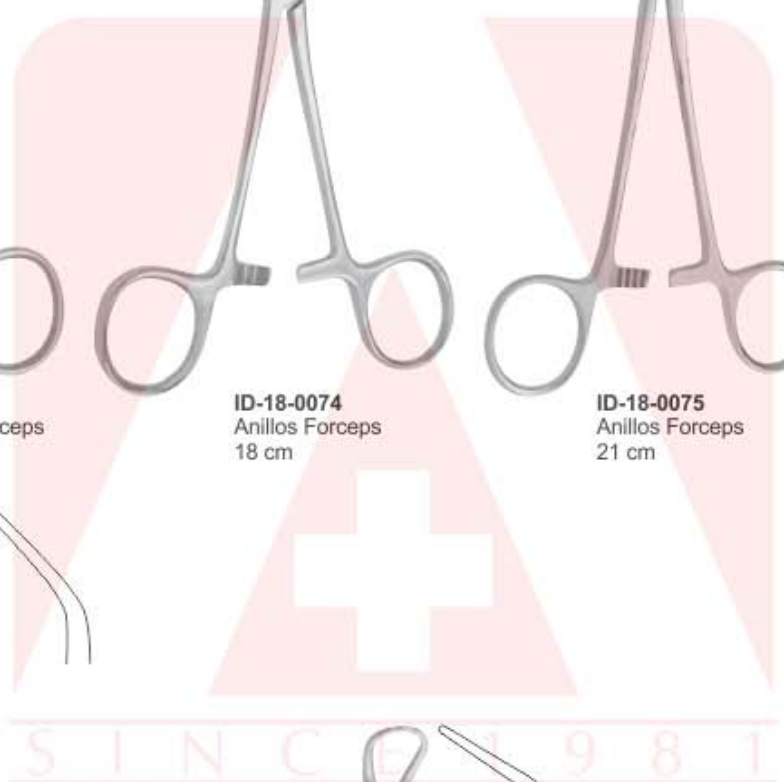



Nadelhalter
Porta-agujas

Porte-agujas
Portaghi



ID-18-0080
Mathieu Needle
Holders 12 cm



ID-18-0081
Mathieu Needle
Holders 14 cm



ID-18-0082
Castroviejo Needle
Holders Straight 14 cm



ID-18-0083
Castroviejo Needle
Holders Curve 14 cm



ID-18-0084
Mayo Heger
Needle Holders
12 cm

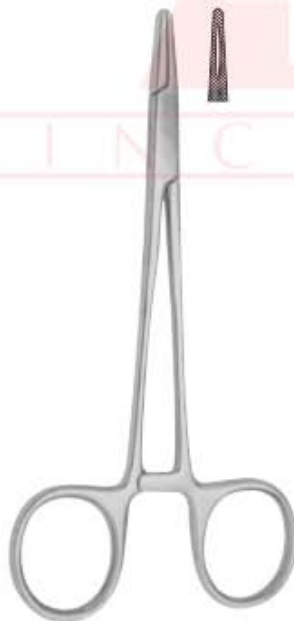

ID-18-0085
Mayo Heger
Needle Holders
14 cm



ID-18-0086
Mayo Heger
Needle Holders
16 cm



ID-18-0087
Mayo Heger
Needle Holders
18 cm

S I N C E 1 8 1



*Plaster Knives/mixing Spatula
Gipsmesser/anmischpatel*

*Couteaux à plâtre/Spatule à Malaxer
Cuchillos para yeso/Espatula para mezclar*



ID-18-0088
Plaster Spatula
Flexible



ID-18-0089
Buffalo
Plaster Spatula



ID-18-0090
Fahnenstock
(Small) Knife
and Spatula



ID-18-0091
Fahnenstock
(Large) Knife
and Spatula



ID-18-0092
Gritman
Knife



ID-18-0093
Plaster Cutting
Knife Large
buffalo type



ID-18-0094
Plaster Cutting
Knife Small
buffalo type



ID-18-0095
Plaster Cutting Plier



Wax Knives, Bone Files
Wachsmesser, Knochenfeilen

couteaux à cire, Limes à os
cuchillos para cera, Limas para huesos



ID-18-0096A

ID-18-0096
12.5 cm
Antkoviak



ID-18-0097
13 cm



ID-18-0098
17 cm

Fahamenstock



ID-18-0099 K
13 cm

rostfrei/stainless
inox



ID-18-0100
17 cm



ID-18-0101
13 cm

Lessmann



ID-18-0102
17 cm



ID-18-0103
13 cm

Ermert



ID-18-0104
Legra Molt



ID-18-0105
Bone File No.11



ID-18-0106
Bone File No.12



ID-18-0107
Curette of
Lucas No.1



ID-18-0108
Legra Seldin

SINCE 1981



Долота плоскі та овальні Flachmeißel Hohlmeißel

Burins et gouges Cinceles y gubias

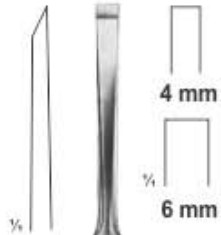

ID-18-0109/4 mm
ID-18-0110/6 mm
Lucas 16 cm



ID-18-0111/3 mm
ID-18-0112/5 mm
Lucas 16 cm



ID-18-0113
Gardner 17 cm



ID-18-0113/1



ID-18-0113/2



ID-18-0113/3



ID-18-0113/4



ID-18-0113/5

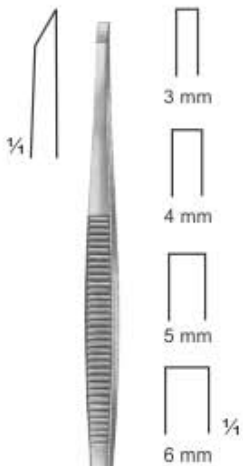

ID-18-0114/3 mm
ID-18-0115/4 mm
ID-18-0116/5 mm
ID-18-0117/6 mm
Partsch 14 cm



ID-18-0118/3 mm
ID-18-0119/4 mm
ID-18-0120/5 mm
ID-18-0121/6 mm
Partsch 17 cm



ID-18-0122/3 mm
ID-18-0123/4 mm
ID-18-0124/5 mm
ID-18-0125/6 mm
Partsch 14 cm



ID-18-0126/3 mm
ID-18-0127/4 mm
ID-18-0128/5 mm
ID-18-0129/6 mm
ID-18-0130/7 mm
Partsch 17 cm



Retractors - Mouth Gags
Wundspreizer Mundsperrer

Ecarteurs - Ouvre-bouches
Separadores - Abre-bocas



ID-18-0131
1
weitlaner
10.5cm
13.5cm



ID-18-0132
2
weitlaner
10.5cm
13.5cm



ID-18-0133
Stainless Steel
Double
Ended Cheek
Retractors



ID-18-0134
Stainless Steel
Single
Ended Cheek
Retractors



Weitlander
ID-18-0135 11cm
ID-18-0136 13cm
ID-18-0137 15cm



ID-18-0141
12 cm
Denhard



ID-18-0142
16 cm
Roser-König



ID-18-0143
19 cm
Roser-König



Jennings
ID-18-0138 11cm
ID-18-0139 13cm
ID-18-0140 15cm



Retractors - Mouth Gags
Wundspreizer Mundsperrer

Ecarteurs - Ouvre-bouches
Separadores - Abre-bocas



ID-18-0144
Mouth Gag Molt
10 cm for (Children)



ID-18-0145
Mouth Gag Molt
14 cm for (Adults)

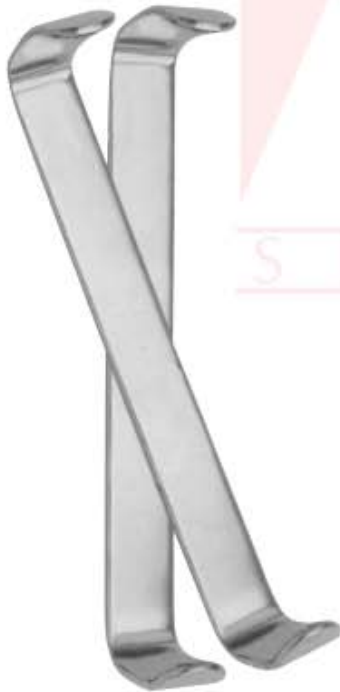

ID-18-0146
Farabeuf
(120 X 12mm Set of 2 pices)



ID-18-0147
Minnesota university
140 mm



ID-18-0148
Retractor Seldin

S I N C 1 9 8 1



Matrix Retainers
Matrizenspanner

Portamatrices
Port-matrices



ID-18-0149
Tofflemire-Junior
45 mm



ID-18-0150
Tofflemire-Universal
60 mm



ID-18-0151
Matrix Ivory 8
6 mm



ID-18-0152
Didner 8 P
70 mm
ADJUSTABLE



ID-18-0153/7



ID-18-0154/8



ID-18-0155/9



ID-18-0156/10

FOR MOLARS AND PREMOLARS



ID-18-0157/11



ID-18-0158/12



ID-18-0159/13
Tofflemire

S I N C E 1 9 8 1



ID-18-0160
Ivory 12



ID-18-0161
Ivory 1



ID-18-0162
Ivory



ID-18-0163
Elliot



*Amalgam carriers
Amalgampistolen*

*Porte-anakganes
Porta-amalgamas*



ID-18-0164
Applicator for
Calcium Hydroxide
Placer (Single End)



ID-18-0165
Applicator for
Calcium Hydroxide
Placer (Double End)



ID-18-0166
Applicator for
Calcium Hydroxide
Placer with
mini spatula



ID-18-0167
Amalgam Carrier
(Single end)



ID-18-0168
Amalgam Carrier
(Double End)



ID-18-0170
Amalgam Carrier
(Single end
Syringe type)



ID-18-0171
Straight
(2.3mm Tip)



ID-18-0172
Right Angle
(2.3mm Tip)



ID-18-0173
Mini Right Angle
(1.25mm Tip)



ID-18-0169
AMALGAM WELL
Stainless Steel

SINCE 1981



Caliper / Calipers Rule
Tasterzirkel / Schiebelehre

Compas d'épaisseur / pied a coulisse
Calibradores / pie de rey



ID-18-0174
Delux Boley
Gauge



ID-18-0175
Boley Gauge



ID-18-0176
Beerendonk
130mm
Mini Gauge



ID-18-0177
Bone Bracket Gauge



ID-18-0178
Boley Gauge
130mm



ID-18-0179
Iwanson 100mm
Decimal Spring Caliper
for Metal and Porcelain



ID-18-0180
Iwanson 100mm
Decimal Spring Caliper
for wax



ID-18-0181
OSTEOMETER
Measuring Forceps For Jaw Ridge Width
measurement, scale on both sides,
rustfree, autoclavific

DENTAL SYRINGES



Dental Syringes, new patterns
Dental-Spritzen, neue Modelle

Seringues dentaires, nouveaux modèles
Jerinas dentales, modelos nuevos



ID-18-0182
86-100
1.8 cc
Self Aspirating



ID-18-0183
86-80
"A" Type



ID-18-0184
86-70
Self Aspirating Syringe
"CW" Type



ID-18-0185
86-60
"CW"
Gun Load Type



ID-18-0186



ID-18-0187
86-50
"A" Gun Load Type



ID-18-0188
86-40
"A" Front Load Type



ID-18-0189
1000
Intraligamental
Anesthesia Syringe
in Mirror Finish
Auto Cleavable



ID-18-0190
1001
Intraligamental
Anesthesia Syringe
in Black Colour
Auto Cleavable

RUBBER-DAM PUNCH CLAMP FORCEPS



Rubber-Dam Punch Clamp Forceps

Perforateur a digue pinces porte-crampons a digue

Kofferdam-Lochzangen Klammerzangen

perforador para dique de caucho pinzas de engrapar para dique de caucho

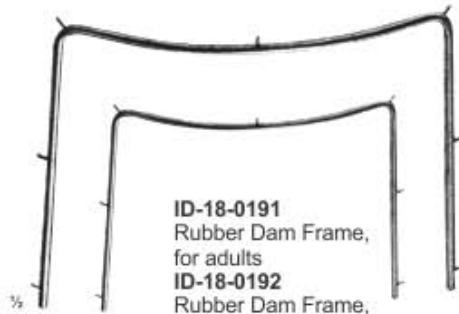

ID-18-0191
Rubber Dam Frame,
for adults
ID-18-0192
Rubber Dam Frame,
for children



ID-18-0193
Complete set of 3 pcs.



ID-18-0194
Anisworth



ID-18-0195
Anisworth



ID-18-0196
Ivory
with 1 row of holes



ID-18-0197
Ivory
with 2 row of holes



ID-18-0198
Ivory



ID-18-0199
Brewer



ID-18-0200
Stockes



ID-18-0201
Palmer



ID-18-0202
Seaparating
Elastic
Plier



ID-18-0203
Elastic
Seaparating
Plier



**Crown Removers
Kronenabnehmer**

**Removedores de Coronas
Arrache-couronnes**



ID-18-0204
Guyer No.7
Serrated



ID-18-0205
Guyer No.7
Plane



ID-18-0206
Flashing Crown
Remover



ID-18-0207
Placement 1



ID-18-0208
Calcium Hydroxide
Placement



ID-18-0209
Morrell Crown
Remover Set



Points 1 & 2)



Fully Automatic
Crown Remover
ID-18-0210



ID-18-0210/1



ID-18-0210/2



ID-18-0210/3

Including 3 Points
in a complete set



ID-18-0211
Crown Remover
(Double Ended)



ID-18-0211/1 **ID-18-0211/2**
Crown Remover
Spare Two Points





ID-18-0212
Bur Changer Square Key
for Japanese Product



ID-18-0213
Bur Changer
Hexagonal Key



ID-18-0214
X-ray Holder
Clip Single



ID-18-0215
X-ray Holder
Set of 6 Clips



ID-18-0216
X-ray Holder
Set of 10 Clips



ID-18-0217
X-ray Holder
Set of 14 Clips



*Orthodontic Instruments,
Orthodontic Pliers, Cutters,
Impression Trays, Articulators*

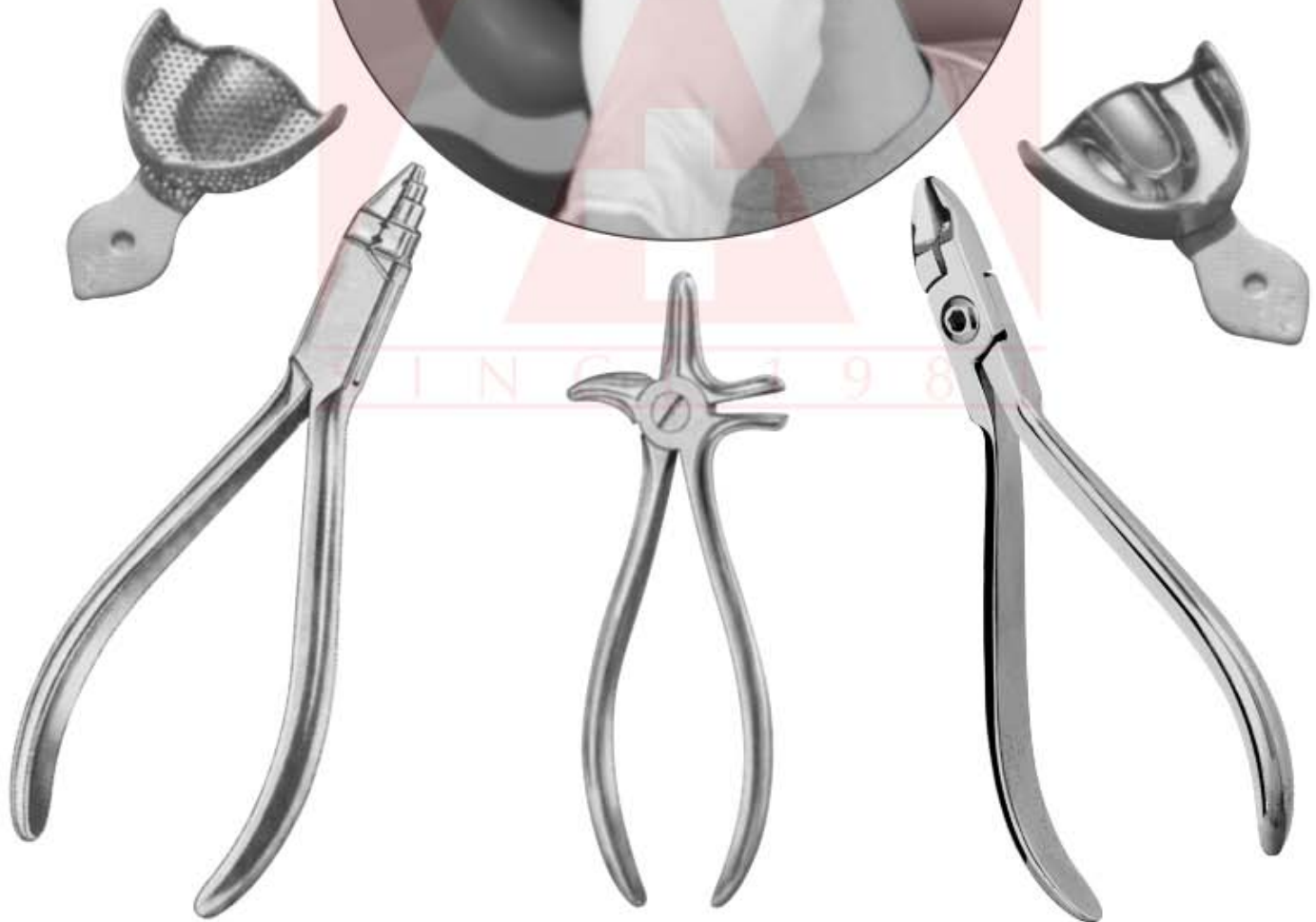

Orthodontics Instruments
Orthodontische Instrumente

Instrumentos Ortodonticos
Instruments Orthodontiques

BRACKET HOLDER TWEEZERS



ID-20-0001
Bracket Placer
Tweezers
(Extra Fine Tip)



ID-20-0002
Easy Access
Tweezers

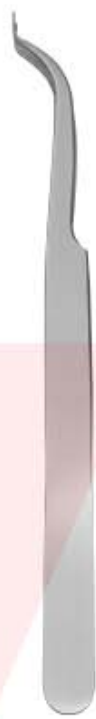

ID-20-0003
Slipper
Tweezers



ID-20-0004
Direct bonding
bracket holders
135mm



ID-20-0005
Direct bonding
bracket holders
136mm



ID-20-0006
Direct bonding
bracket holders
135mm



ID-20-0007
Deluxe Bracket
Holder



ID-20-0008
Direct bonding
bracket holders
140mm



ID-20-0009
Deluxe Bracket
Holder Tweezers



ID-20-0010
Deluxe Bracket
Holder Tweezers



ID-20-0011
Direct Bond
Bracket Holder
Tweezers



ID-20-0012
Bracket
Tweezers
Slot Aligner



ID-20-0013
Direct Bond
Bracket Holder
Tweezers, Small Tip



ID-20-0014
Exact Bracket
Holder Tweezers

Orthodontics Instruments
Orthodontische Instrumente

Instrumentos Ortodonticos
Instruments Orthodontiques

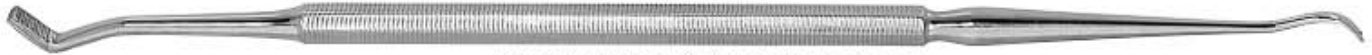

ID-20-0015 Ortho Light Band Pusher Scaler



ID-20-0016 Ortho Light double ended ligature director



ID-20-0017 Ortho Light double ended ligature director scaler



ID-20-0018 Ortho Light double ended ligature scaler/director
tivate coil spring are remove modules with one instruments



ID-20-0019 Ortho band pusher scaler



ID-20-0020 Ortho Light Band Pusher Scaler



ID-20-0021 Ortho ligature director single ended



ID-20-0022 Ortho Light double ended ligature director scaler



ID-20-0023 Ortho Light double ended ligature scaler/director
tivate coil spring are remove modules with one instruments



ID-20-0024 Ortho Light double ended ligature director



ID-20-0025 Ortholite Ligature Director Scaler



ID-20-0026 Double ended cement spatula



ID-20-0027 Ortho light ligature director double ended



ID-20-0028 Ortho light scaler single ended

Orthodontics Instruments
Orthodontische Instrumente

Instrumentos Ortodonticos
Instruments Orthodontiques



ID-20-0029 Ortho light scaler double ended



ID-20-0030 Ortho light scaler double ended



ID-20-0031 Ortho light scaler double ended



ID-20-0032 Twiel-on elastic module instrument



ID-20-0033 Twiel-on elastic module instrument



ID-20-0034 Schure Band Seater



ID-20-0035 Ortho light scaler



ID-20-0036 Ortho light scaler



ID-20-0037 Ortho light scaler heavy



ID-20-0038 Ortho instrument



ID-20-0039 Ortho instrument



Orthodontics Instruments
Orthodontische Instrumente

Instrumentos Ortodonticos
Instruments Orthodontiques



ID-20-0040 Band seater auto cleavable



ID-20-0041 Band seater auto cleavable



ID-20-0042 Ortho instrument

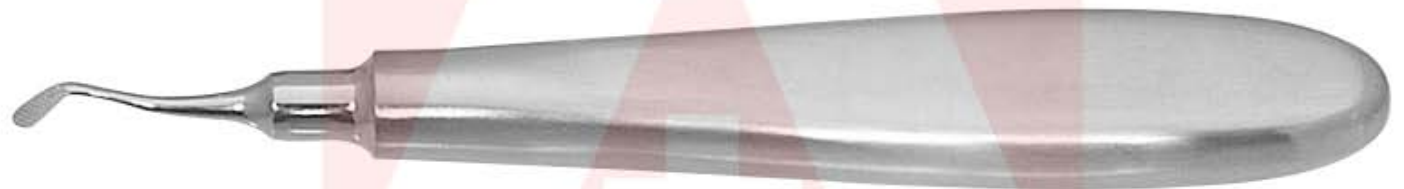

ID-20-0043 Heavy duty band pusher



ID-20-0044 Positive Positioner



ID-20-0045 Polar Bear Ice Instruments



ID-20-0046 Distal Bender



Pliers for orthodontics and prosthetics
Zangen für Kieferorthopädie und Prothetik

Pinces pour l'orthodontie et la prothèse
Alicates para ortodoncia y prótesis



ID-20-0047
T.C
angled direct
bond bracket
remover



ID-20-0048
T.C
Pin holding plier



ID-20-0049
T.C
tweed loop
forming plier



ID-20-0050
T.C
straight direct
bond bracket
remover



ID-20-0051
T.C
flat nose plier



ID-20-0052
bird beak plier

S I N C E 1 9 8 1



Pliers for orthodontics and prosthetics
Zangen für Kieferorthopädie und Prothetik

Pinces pour l'orthodontie et la prothèse
Alicates para ortodoncia y prótesis



ID-20-0053
T.C
V bend stop plier



ID-20-0054
T.C
Utility plier
weingart



ID-20-0055
T.C
standard ligature
cutter



ID-20-0056
T.C
V bend stop plier



ID-20-0057
T.C
mini pin and
ligature cutter



ID-20-0058
T.C
3-prong clasp
adjustable plier

S I N C E 1 9 8 1



Pliers for orthodontics and prosthetics
Zangen für Kieferorthopädie und Prothetik

Pinces pour l'orthodontie et la prothèse
Alicates para ortodoncia y prótesis



ID-20-0059
T.C
Distal End Cutter
Safety hold is ideal for cutting wires within the patient's mouth.



ID-20-0060
T.C
angled direct bond bracket remover



ID-20-0061
T.C
Direct bonding bracket remover (wide) plier



ID-20-0062
T.C
Hook crimping pliers angled straight



ID-20-0063
T.C
Pin and ligature cutter



ID-20-0064
T.C
Direct bracket remover

SINCE 1981



Pliers for orthodontics and prosthetics
Zangen für Kieferorthopädie und Prothetik

Pinces pour l'orthodontie et la prothèse
Alicates para ortodoncia y prótesis

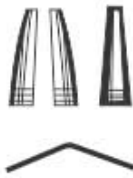

ID-20-0065
 Aderer Clamp three jaw wire bending plier for contouring and bending wire up to .30"/0.76mm.

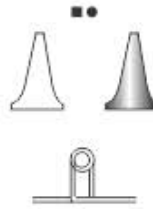

ID-20-0066
 Bird beak plier for bending round, square and rectangle wire up to .30"/0.76mm.

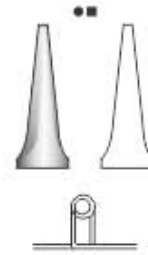

ID-20-0067
 Bird beak plier for light wire bending round, square and rectangular up to .016"/0.41mm.

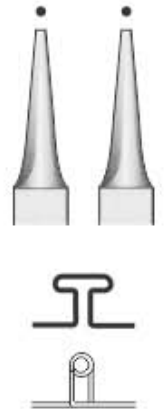
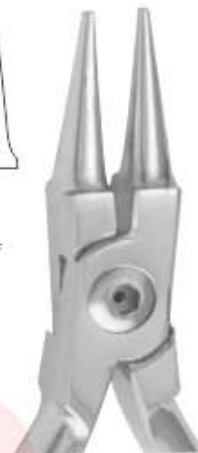

ID-20-0068
 Double Rounded jaw bending pliers, hooks and wire up to .020"/0.51mm.

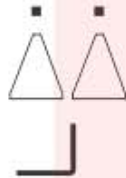

ID-20-0069
 Adams pliers for hooks and bending wire up to .030"/0.76mm.



ID-20-0070
 Johnson pliers for crown band contouring

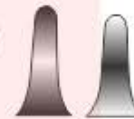

ID-20-0071
 Falcon beak contouring plier.



ID-20-0072
 For placement and removal of arch wires, pins and other auxiliaries.



ID-20-0073
 For placement and removal of arch wires, pins and other auxiliaries in angle design



ID-20-0074
 Bending Plier. In order to skirt molar bands. Non grooved.



ID-20-0075
 contouring Plier.



ID-20-0076
 Bending plier. In order to skirt molar bands. With grooved. Recommended wire. 016", 018" and 022" 0.41mm, 0.46mm and 0.56mm



Pliers for orthodontics and prosthetics
Zangen für Kieferorthopädie und Prothetik

Pinces pour l'orthodontie et la prothèse
Alicates para ortodoncia y prótesis

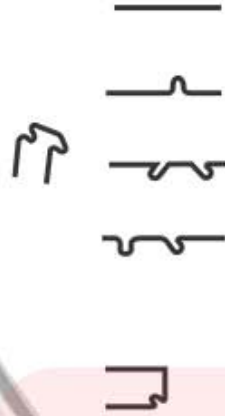

ID-20-0077
 Nance loop closing plier, for bending of stop loops and adams' clasps.
 Wire up to .022" x .028", 0.7mm.

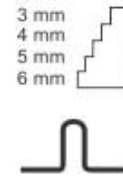

ID-20-0078
 Loop forming in four length 3,4,5 & 6 mm wire capacity 0.22", 56mm.



ID-20-0079
 Arch bending plier design for convenient handling of square or rectangular wire, .020" / 0.51mm.

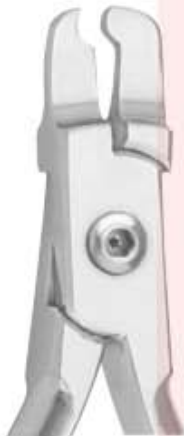

ID-20-0080
 In order to skirt bands and crowns.

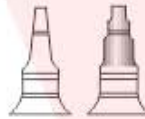

ID-20-0081
 Wires up to .020" / 0.7mm.



ID-20-0082
 Hard wire cutter up to .022" x .028" .56mm x 71mm.



ID-20-0083
 Round and concave plier for loop forming and banding wire up to .20" / .051mm.



ID-20-0084
 Bending for round square or rectangular wire up to 0.30"/0.76mm



ID-20-0085
 Plier for double bars.



ID-20-0086
 for double back and triple back bands in 0.30" / .76mm & 0.36" / .91mm lingual arch wires.



Pliers for orthodontics and prosthetics
Zangen für Kieferorthopädie und Prothetik

Pinces pour l'orthodontie et la prothèse
Alicates para ortodoncia y prótesis



ID-20-0087
 Angle
 14.5 cm, 5 1/2"
 Bandformzange
 Band forming plier
 Pince à former les bagues
 Alicates para formar bandas



ID-20-0088
 Peeso
 13 cm, 5"



ID-20-0089
 Peeso
 13 cm, 5"

Kronenbänderzangen
 Collar Pliers
 Pinces pour bandes à couonnes
 Alicates para cuellos



ID-20-0090
 Peeso
 14.5 cm, 5 1/2"

Kronenstreckzangen
 Crown stretching pliers
 Pinces à étendre les couonnes
 Alicates para ensanchar coronas



ID-20-0091
 Peeso
 14.5 cm, 5 1/2"



ID-20-0092
 Peeso
 14.5 cm, 5 1/2"

Zang flach/rund
 Plier flat and round
 Pince plate et ronde
 Alicates plano y redondo



ID-20-0093
 16 cm, 6 1/4"

Universal-Kramponzangen
 Pin Roughening-Cutting and Bending Pliers
 Pinces universelle pour crampons
 Alicates para pone asperas



ID-20-0094
 16 cm, 6 1/4"

Pliers for orthodontics and prosthetics
Zangen für Kieferorthopädie und Prothetik

Pinces pour l'orthodontie et la prothèse
Alicates para ortodoncia y prótesis



ID-20-0095
 13 cm, 5"



ID-20-0096
 Schwarz
 13 cm, 5"



ID-20-0097
 Schwarz
 13 cm, 5"



ID-20-0098
 Schwarz
 14 cm, 5 1/4"

Draht- und Biegelbiegezangen
 Arch and Spring Bending Pliers
 Pinces à plier les fils et les barres
 Alicates para doblar alambre y barras



ID-20-0099
 12.5 cm, 4 3/4"

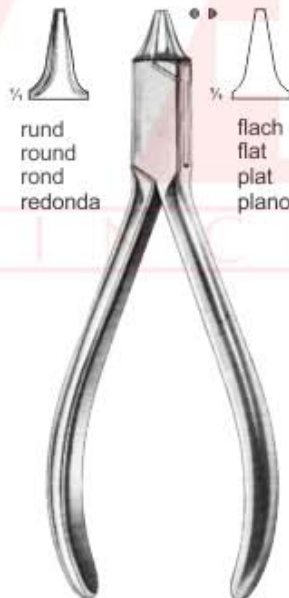

ID-20-0100
 Angle
 12.5 cm, 4 3/4"

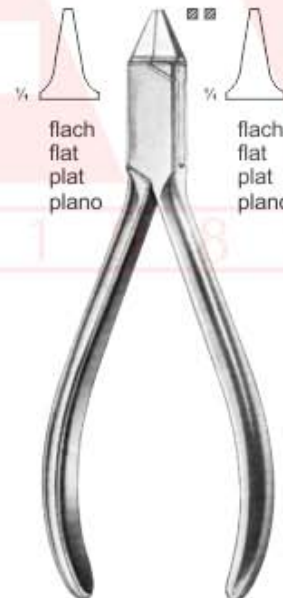

ID-20-0101
 Adams
 12.5 cm, 4 3/4"



ID-20-0102
 13 cm, 5"

Drahtbiegezangen
 Wire Bending Pliers
 Pinces à plier les fils
 Alicates para doblar alambre

Pliers for orthodontics and prosthetics
Zangen für Kieferorthopädie und Prothetik

Pinces pour l'orthodontie et la prothèse
Alicates para ortodoncia y prótesis



ID-20-0103
 Young
 13 cm, 5"

Dahtbiegezange
 Wire Bending Plier
 Pince à courber les fils
 Alicata para doblar alambre

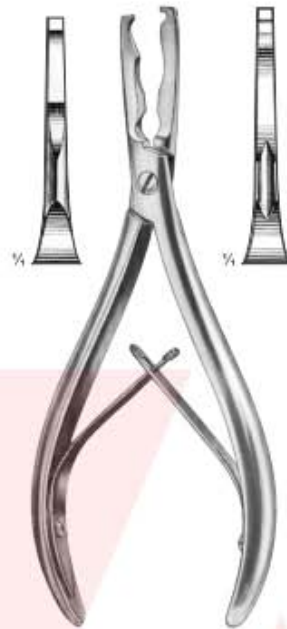

ID-20-0104
 Tryfus
 16.5 cm, 6 1/2"

Kronenformzange
 Crown Forming Plier
 Pince pour former les couronnes
 Alicata para formar coronas



ID-20-0105
 Johnson
 12 cm, 4 3/4"

Konturzangen
 Contouring Pliers
 Pince à bouteroller
 Alicata para contornear



ID-20-0106
 Reynolds
 13 cm, 5"

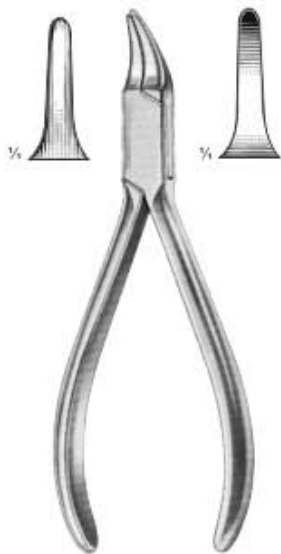

ID-20-0107
 Gordon
 13.5 c, 5 1/4"

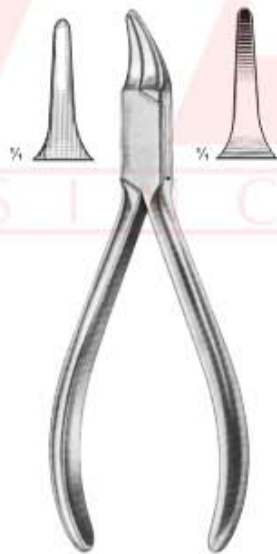

ID-20-0108
 USA Modell
 13.5 cm, 5 1/4"

Konturzangen
 Contouring Pliers
 Pinces à bouteroller
 Alicates para contornear



ID-20-0109
 Goslee
 13.5 cm, 5 1/4"



ID-20-0110
 Frevert
 13 cm, 5"



Pliers for orthodontics and prosthetics
Zangen für Kieferorthopädie und Prothetik

Pinces pour l'orthodontie et la prothèse
Alicates para ortodoncia y prótesis



ID-20-0111
 14 cm, 5 1/2"

Flachzange zum Einsetzen
 von Einschraubspitzen
 Flat nose plier for screw points
 Pince plates pour pointes à vis
 Alicates de picos chatos
 para puntas a rosca

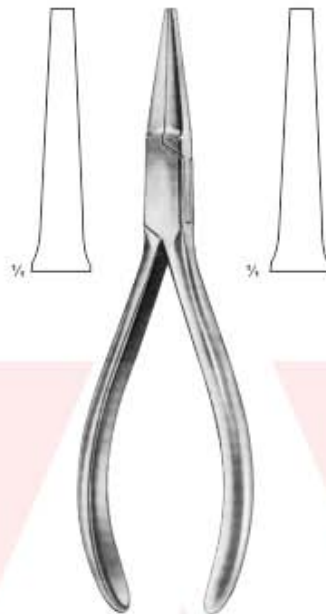

ID-20-0112
 16 cm, 6 1/4"

Flachzangen
 Flat nose pliers
 Pinces plates
 Alicates de picos chatos

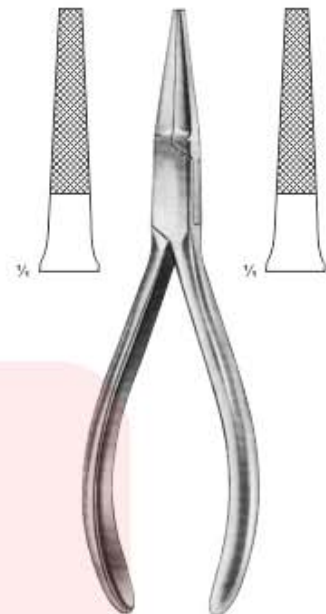

ID-20-0113
 16 cm, 6 1/4"



ID-20-0114
 14 cm, 5 1/2"

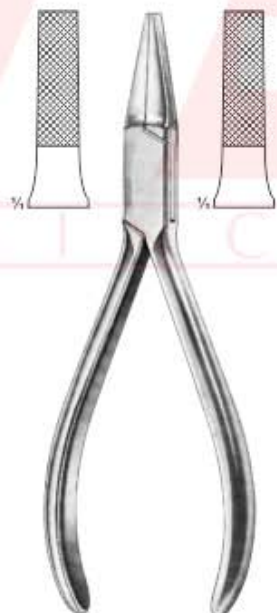

ID-20-0115
 14 cm, 5 1/2"

Flachzangen
 Flat nose pliers
 Pinces plates
 Alicates de picos chatos



ID-20-0116
 13.5 cm, 5 1/4"



ID-20-0117
 13.5 cm, 5 1/4"



Nadelhalter
Porta-agujas

Porte-agujas
Portaghi



ID-20-0118
Mathieu Needle Holders
(Wide Tip) 14 cm



ID-20-0119
Mathieu Ligature
Placing



ID-20-0120
Mathieu Needle Holders
(Narrow Tip) 14 cm



ID-20-0121
Mathieu Forceps
With Hook



ID-20-0122
Mini Mathieu
Needle Holder



ID-20-0123
Mathieu
Elastic Tip



ID-20-0124
Mathieu Narrow Tip Double
Spring (T.C. Tip) Gold Handle



ID-20-0125
Mathieu Medium Tip Double
Spring (T.C. Tip) Gold Handle



Impression Trays-Stainless Steel
Abdruckkloffel S.S.

Cubetas para impresiones de acero inox
Porte-empreintes en acier inoxydable

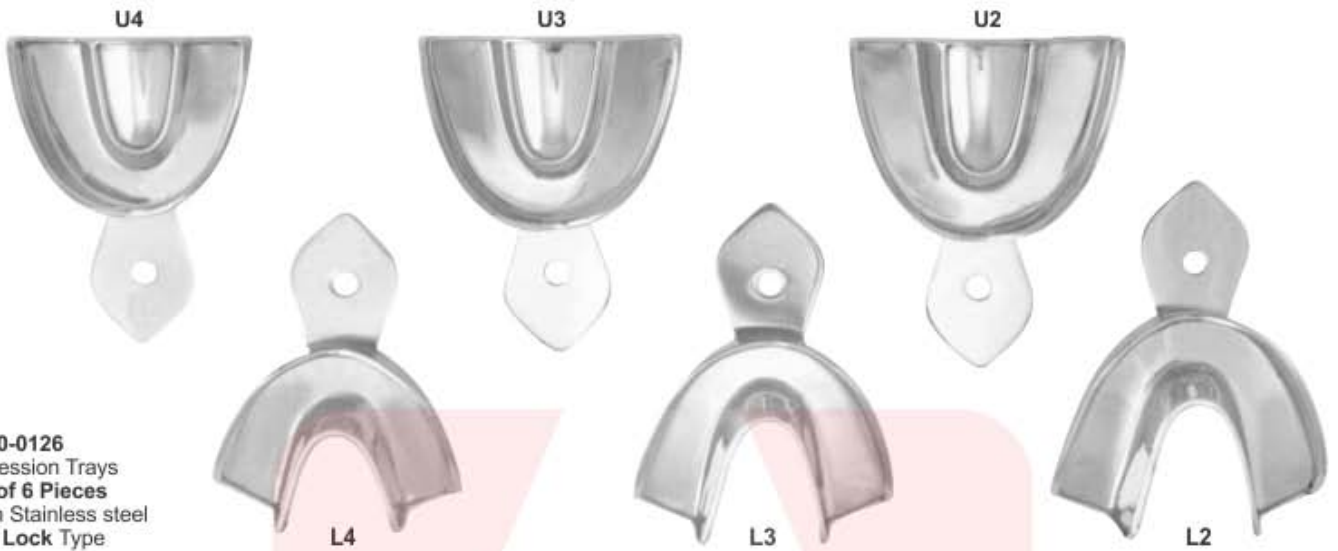

ID-20-0126
Impression Trays
Set of 6 Pieces
Plain Stainless steel
Rim Lock Type

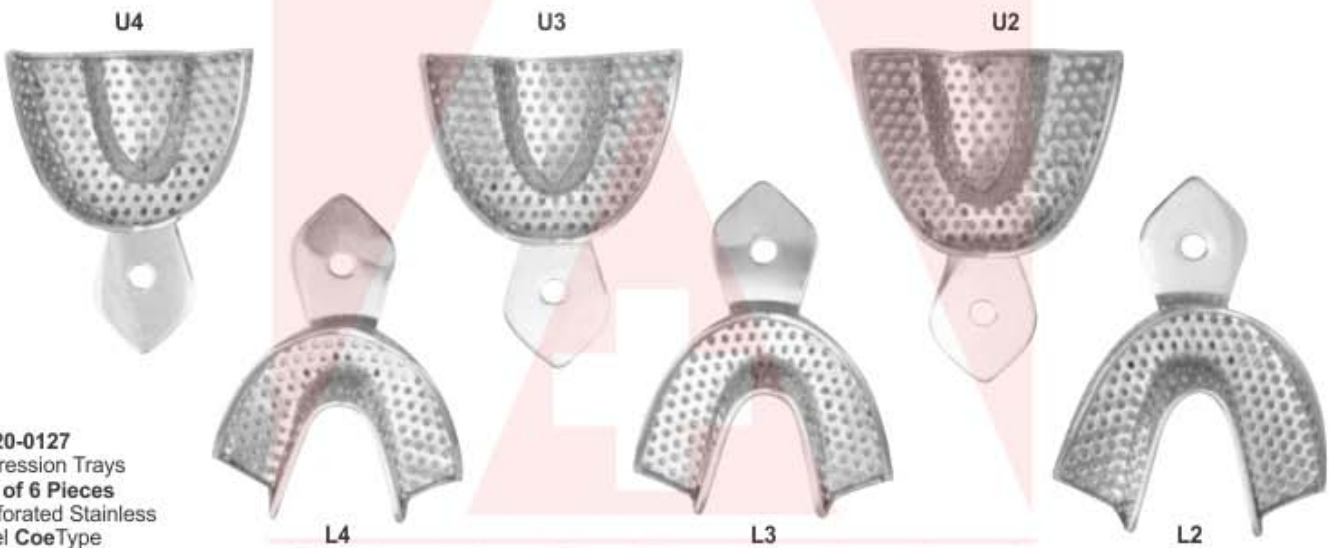

ID-20-0127
Impression Trays
Set of 6 Pieces
Perforated Stainless steel
Coe Type

S I N C E 1 9 8 1

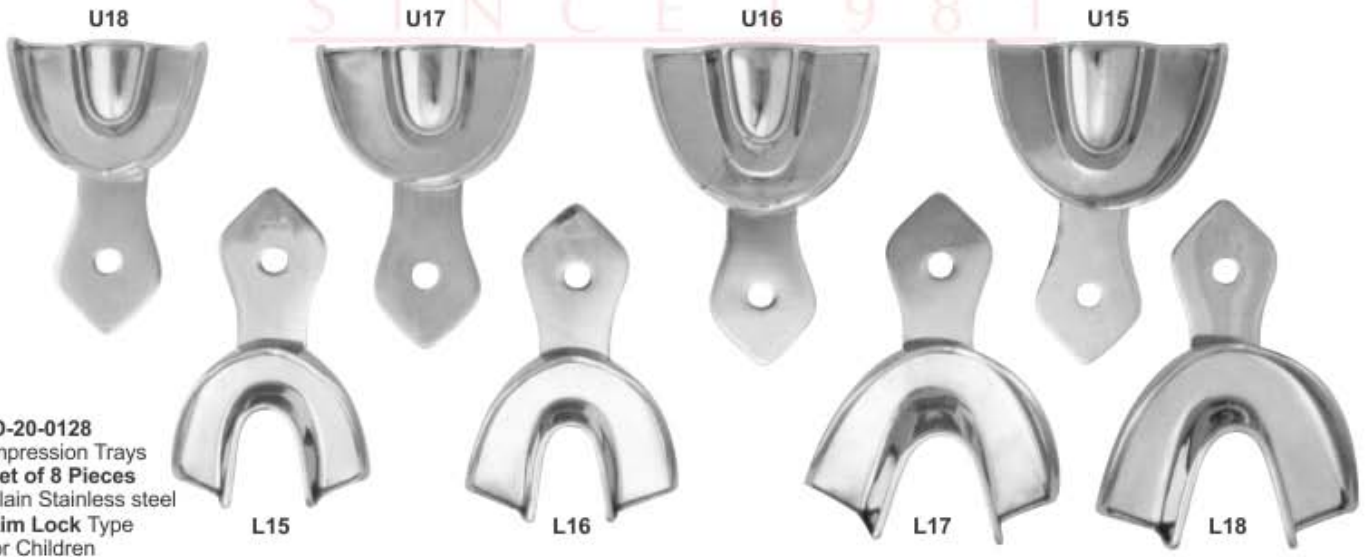

ID-20-0128
Impression Trays
Set of 8 Pieces
Plain Stainless steel
Rim Lock Type
for Children



Impression Trays-Stainless Steel
Abdruckloffel S.S.

Cubetas para impresiones de acero inox
Porte-empreintes en acier inoxydable

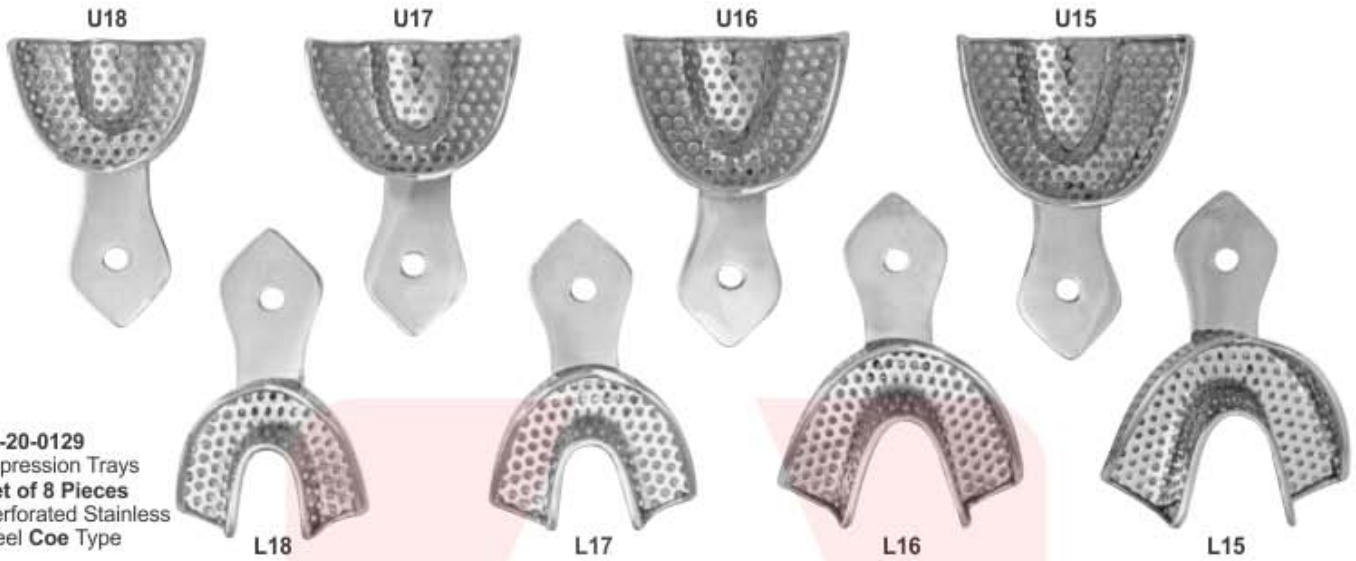

ID-20-0129
Impression Trays
Set of 8 Pieces
Perforated Stainless
steel Coe Type

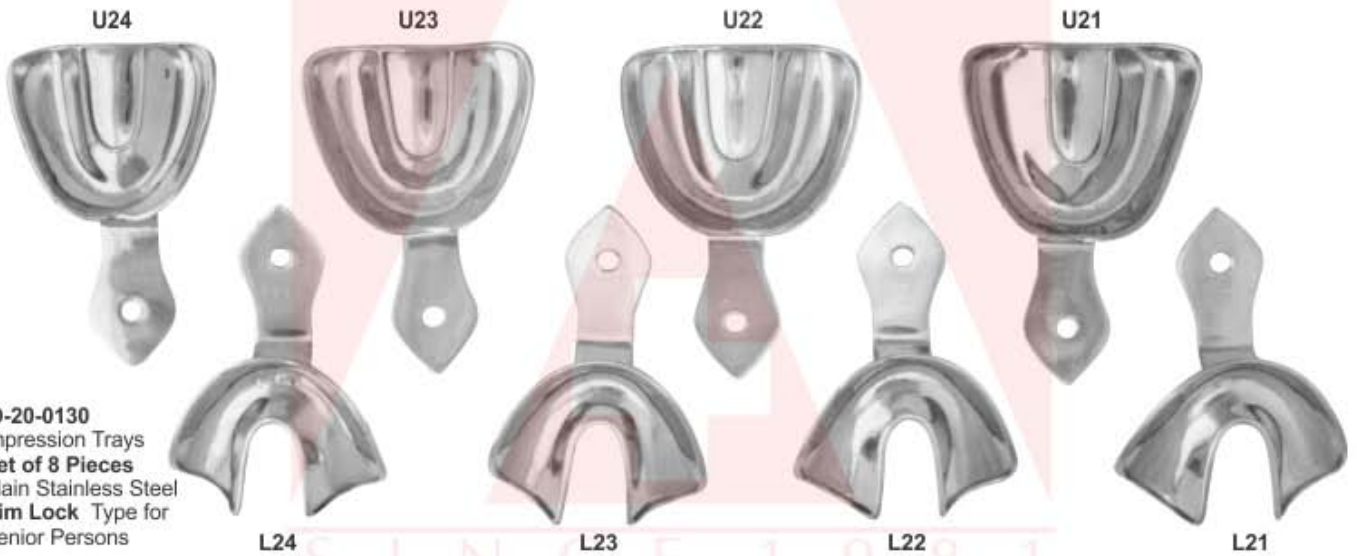

ID-20-0130
Impression Trays
Set of 8 Pieces
Plain Stainless Steel
Rim Lock Type for
Senior Persons

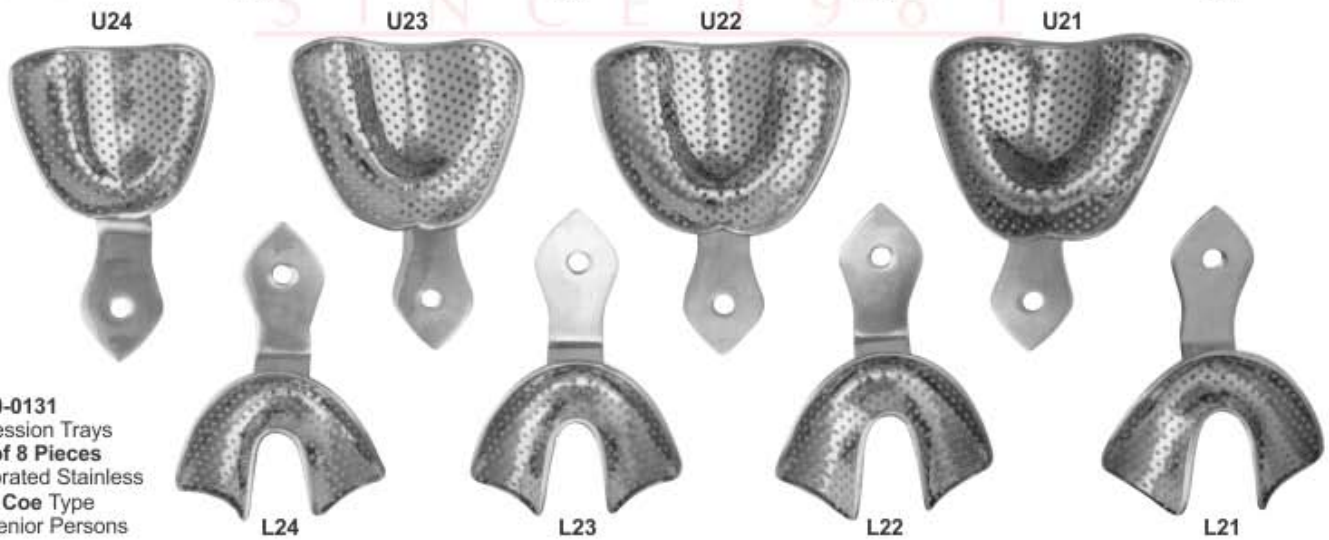

ID-20-0131
Impression Trays
Set of 8 Pieces
Perforated Stainless
steel Coe Type
for Senior Persons



*Articulators
Artikulations*

*Artocilar
Articuler*



ID-20-0132
Stainless Steel
Finishing



ID-20-0133
Golden Black Metallic



ID-20-0134
Golden Orange Metallic



ID-20-0135
Brown



ID-20-0136
Royal Blue



ID-20-0137
Silver Black Metallic

S I N C E 1 9 8 1



ID-20-0138
Silver Blue Metallic



ID-20-0139
Silver Green Metallic



ID-20-0140
Copper Black Metallic



DENTAL IMPLANTS INSTRUMENTS



Імплантологія
Implantologie

Implantologie
Implantologia

Sinus Lift Instruments:

Stainless steel, light weight handles Reduce hand and wrist fatigue Variety of elevators and curettes available
Provides clinicians with the proper instrumentation for lifting the sinus membrane

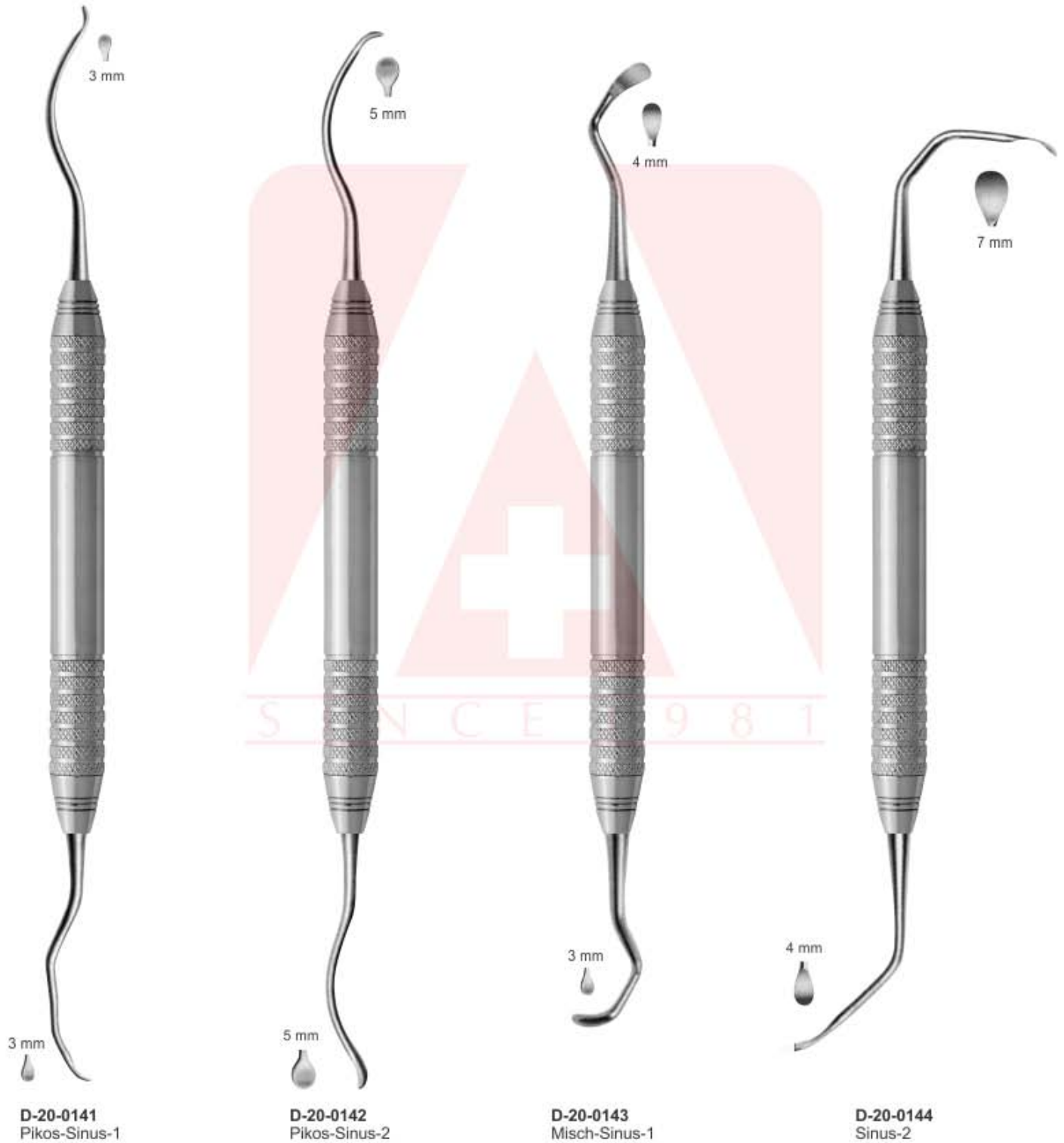



Імплантологія
Implantologie

Implantologie
Implantoloia

Sinus Lift Instruments

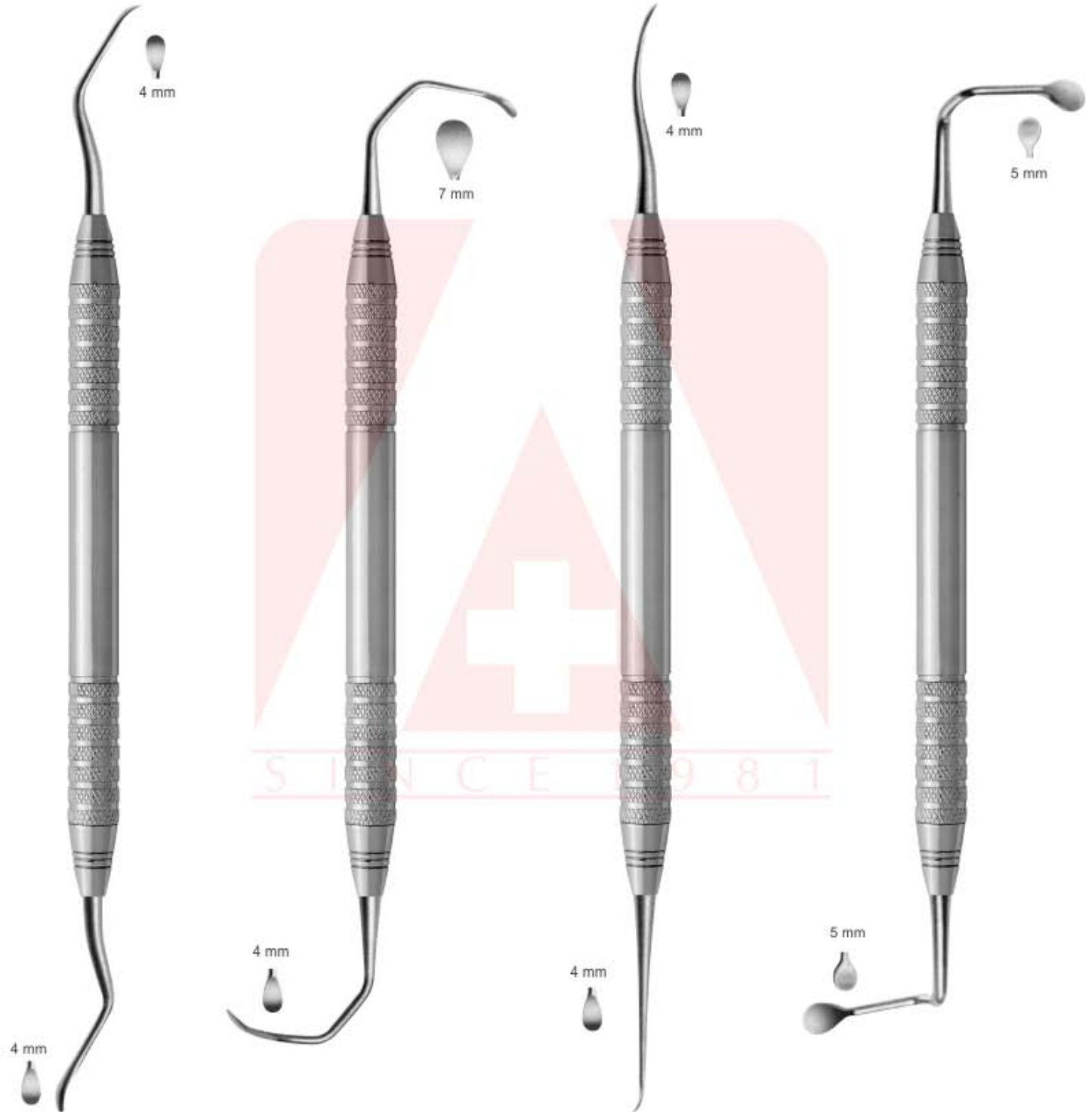

D-20-0145
Mills-Sinus-1

D-20-0146
Mills-Sinus-2

D-20-0147
Mills-Sinus-3

D-20-0148
Sinus-4

Імплантологія
Implantologie

Implantologie
Implantoloia

Sinus Lift Instruments

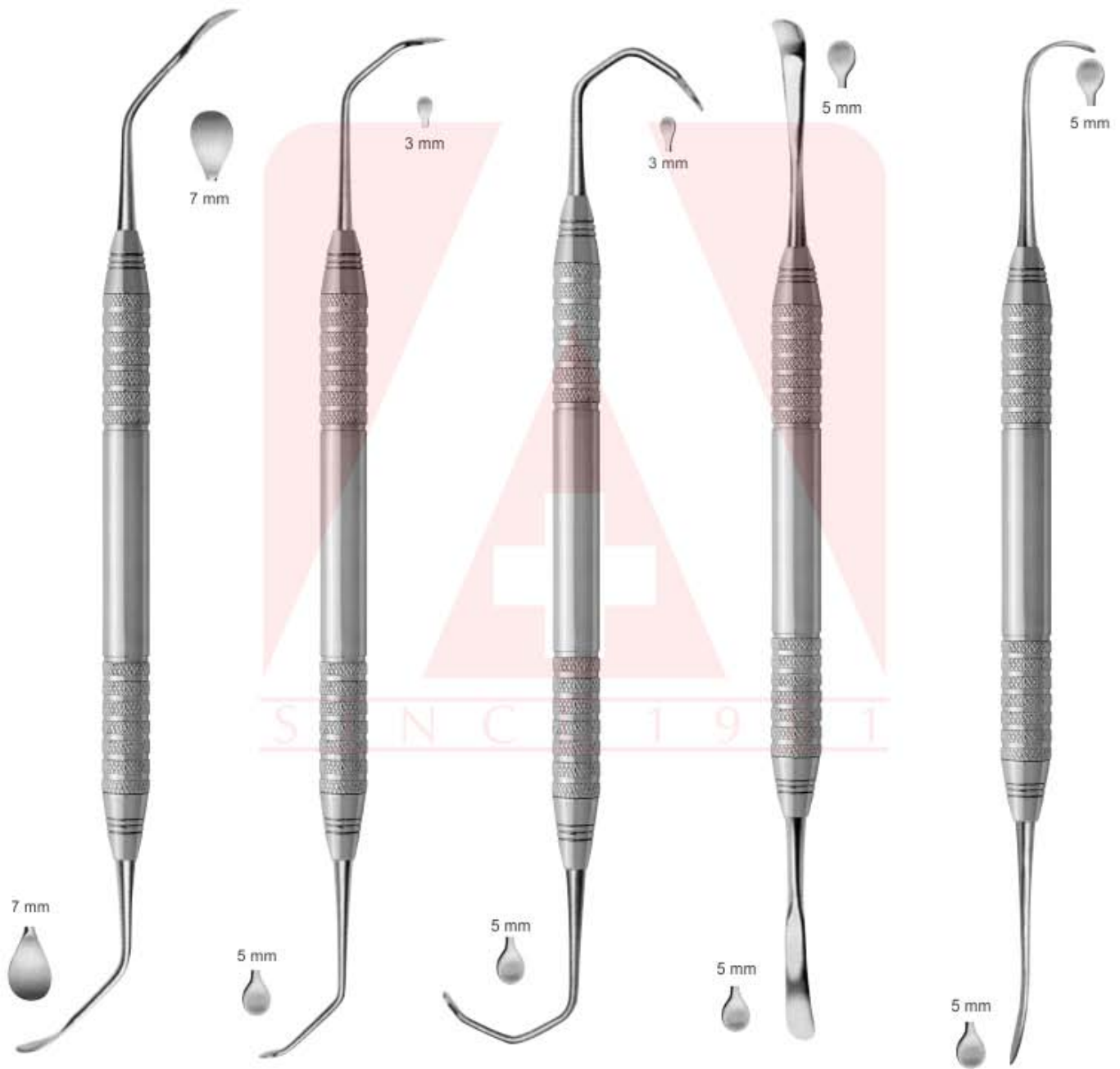

D-20-0149
Sinus-1

D-20-0150
Sinus-5

D-20-0151
Sinus-6

D-20-0152
Sinus-Freer

D-20-0153
Sinus-Freer-Cu



Імплантологія
Implantologie

Implantologie
Implantoloia

Manual Bone Mill, Holding & Drilling Forceps

Ideal for Chairside Preparation of
Autogenous Bone Grafts
Bone Morselizer Bone Morselizer
D-20-0154 Bone morselizer



1. Adjust the spacing screw (located at the hinge of the handles) to the desired spacing requirements between knurled surfaces.

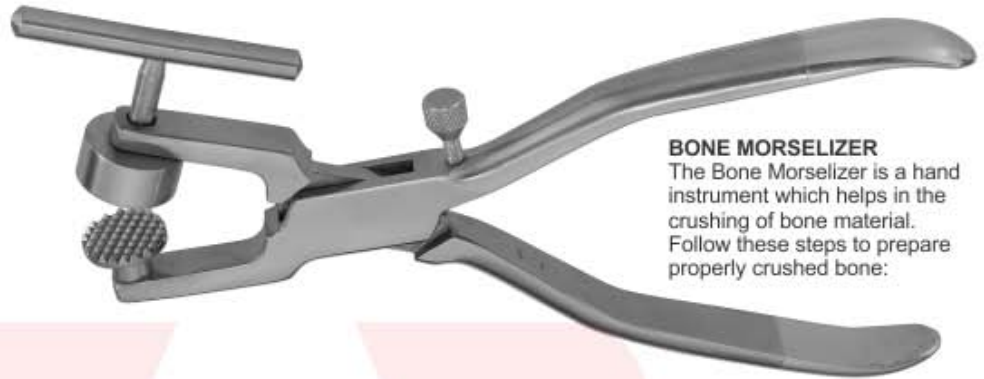

BONE MORSELER
The Bone Morselizer is a hand instrument which helps in the crushing of bone material. Follow these steps to prepare properly crushed bone:



2. Place the bone material into the bone well.



3. Compress handles together in order to create pressure on the bone material.



4. Turn the bone morselizer clockwise as the handles are squeezed. Always maintain a slight space between the two knurled surfaces, by using the spacing screw.



5. To remove bone, press the T-handle and bone will express from the bone well.



D-20-0155
EASY Bone Manual
Bone Mill to chop Bone
Fragments

S I M P L E 1 9 8 1



D-20-0156
Bone Mill



D-20-0157
Basins For Bone

Імплантологія
Implantologie

Implantologie
Implantoloia

Compactor /tampers Bone Grafting Instruments



D-20-0158
Compactor
150mm



D-20-0159
Compactor
155mm



D-20-0160 Ø 4mm
D-20-0161 Ø 5mm
Compactor
150mm



D-20-0162
Sinus Window
Bone Tampers
4 mm



D-20-0163
Sinus Window
Bone Tampers
7 mm



D-20-0164
Graft Packer,
Concave
Tips DE 4/6mm



D-20-0165
Bone Spoon/
Packer DE 3mm



D-20-0166
Graft Packer,
Serrated Tips
DE 6/8mm



D-20-0167
Graft Packer,
Serrated
TIPS DE 3/4mm



D-20-0168
Graft Packer,
Smooth
TIPS DE 5/8mm



D-20-0169
Titanium graft packer / placement
site depth gauge 3.3mm & 4.0mm Diameter
tips Marked at 8, 11, 13, 15 & 18mm



D-20-0170
Graft Material Spoon With
3mm Serrated Graft Packer
Concave Spoon Tip For
Larger Grafts



D-20-0171
Graft Material Spoon
Concave Tip For
Larger Grafts



Имплантологія
Implantologie

Implantologie
Implantologia

4.0mm ●



5.0mm ●



6.0mm ●



**Stainless Steel Tissue
Punches - Straight**
D-20-0172 4.0mm Straight Punch
D-20-0173 5.0mm Straight Punch
D-20-0174 6.0mm Straight Punch

2.0mm ●



D-20-0175

4.0mm ●



D-20-0176

5.0mm ●



D-20-0177

6.0mm ●



D-20-0178

7.0mm ●



D-20-0179

8.0mm ●



D-20-0180

Stainless Steel Tissue Punches - offset



**Имплантологія
Implantologie**

**Implantologie
Implantoloia**

Chisels

Extremely sharp tips Helps incise ridges during implant preparations Available in curved and straight patterns Provides clinicians with the proper instrumentation for easy access into the implant site

Periotome Handle Blades & Ratchet



D-20-0181
Torque Wrenches
& Drivers



D-20-0182
Ratchet



D-20-0183
Bone Scraper

D-20-0184
3mm

D-20-0185
6mm

D-20-0186
9mm



D-20-0187 4.0mm
D-20-0188 7.5mm
170mm, straight
D-20-0189 4.0mm
D-20-0190 7.5mm
170mm, Curved

D-20-0191 4.0mm
D-20-0192 7.5mm
170mm, straight
D-20-0193 4.0mm
D-20-0194 7.5mm
170mm, Curved



Імплантологія
Implantologie

Implantologie
Implantoloia

Chisels:

Extremely sharp tips Helps incise ridges during implant preparations Available in curved and straight patterns Provides clinicians with the proper instrumentation for easy access into the implant site

Osteotomes:

Depth markings on Osteotome tips Allows clinician to know how deep the instrument is in the socket Available with stops Helps ensure instrument does not penetrate too deep into the socket Extensive product offering Provide clinicians with the proper instrumentation per procedure

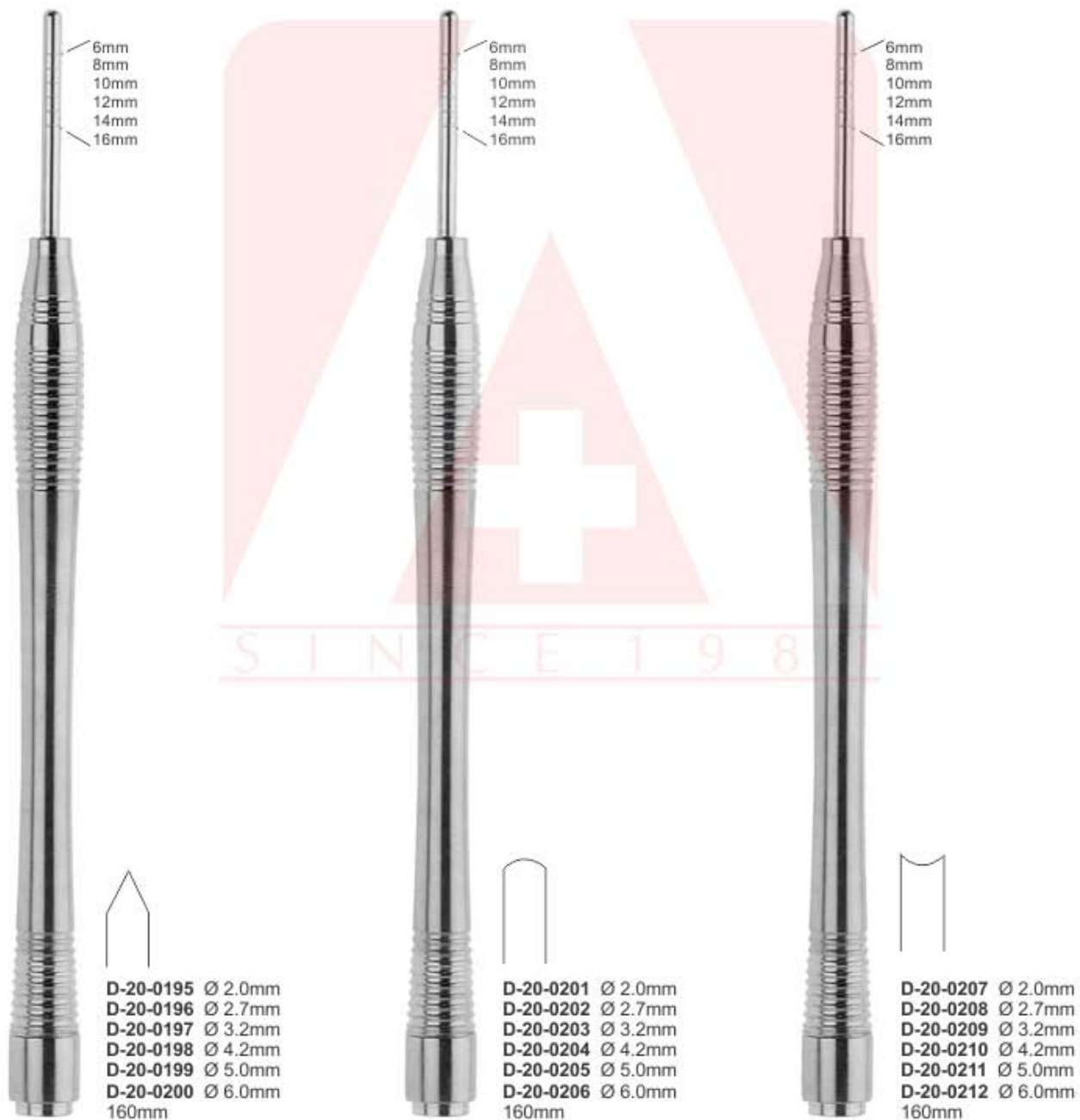



Імплантологія
Implantologie

Implantologie
Implantoloia

Chisels / Osteotomes



Імплантологія
Implantologie

Implantologie
Implantologia

Chisels / Osteotomes

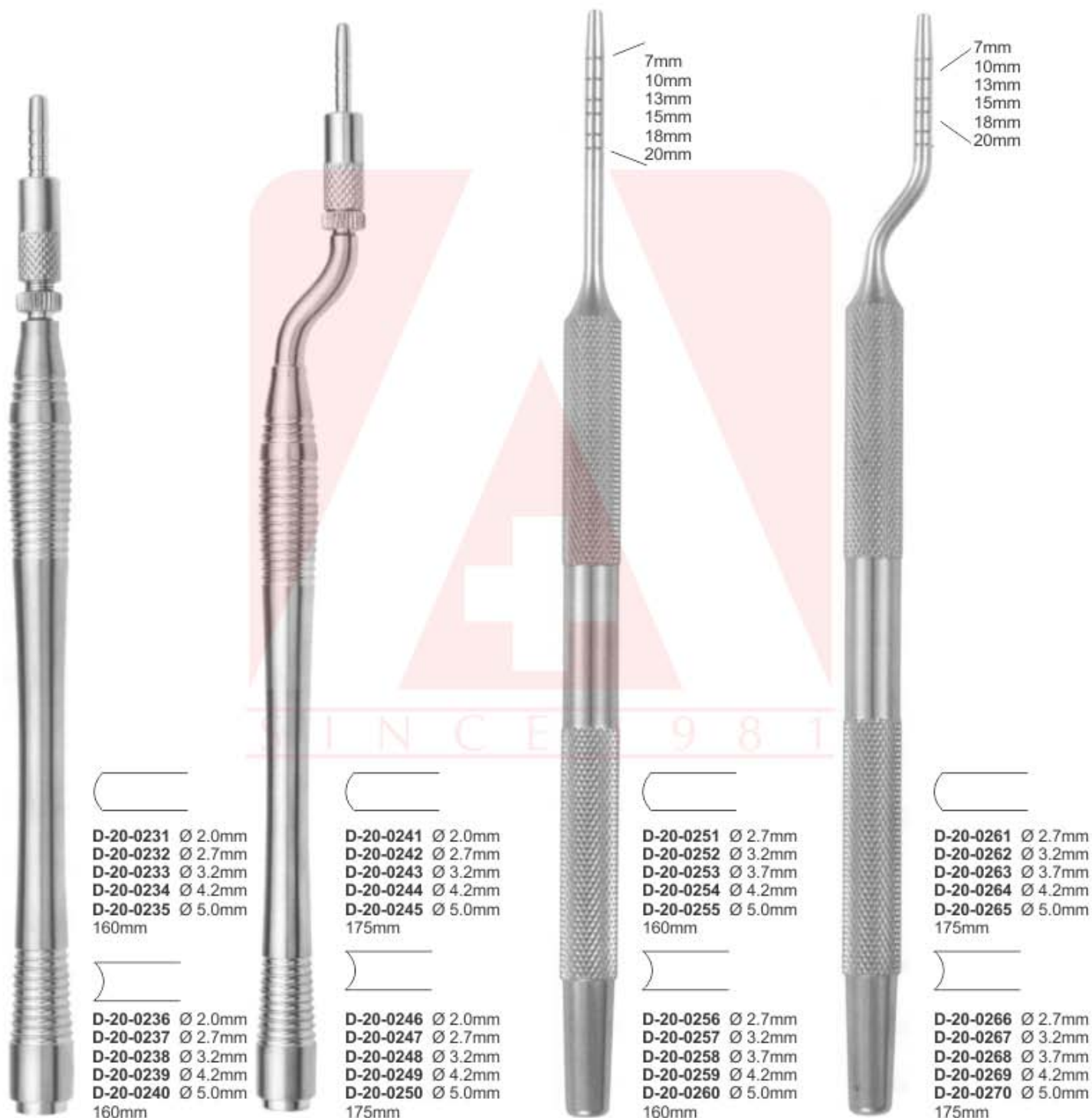

D-20-0231 Ø 2.0mm
D-20-0232 Ø 2.7mm
D-20-0233 Ø 3.2mm
D-20-0234 Ø 4.2mm
D-20-0235 Ø 5.0mm
160mm

D-20-0236 Ø 2.0mm
D-20-0237 Ø 2.7mm
D-20-0238 Ø 3.2mm
D-20-0239 Ø 4.2mm
D-20-0240 Ø 5.0mm
160mm

D-20-0241 Ø 2.0mm
D-20-0242 Ø 2.7mm
D-20-0243 Ø 3.2mm
D-20-0244 Ø 4.2mm
D-20-0245 Ø 5.0mm
175mm

D-20-0246 Ø 2.0mm
D-20-0247 Ø 2.7mm
D-20-0248 Ø 3.2mm
D-20-0249 Ø 4.2mm
D-20-0250 Ø 5.0mm
175mm

D-20-0251 Ø 2.7mm
D-20-0252 Ø 3.2mm
D-20-0253 Ø 3.7mm
D-20-0254 Ø 4.2mm
D-20-0255 Ø 5.0mm
160mm

D-20-0256 Ø 2.7mm
D-20-0257 Ø 3.2mm
D-20-0258 Ø 3.7mm
D-20-0259 Ø 4.2mm
D-20-0260 Ø 5.0mm
160mm

D-20-0261 Ø 2.7mm
D-20-0262 Ø 3.2mm
D-20-0263 Ø 3.7mm
D-20-0264 Ø 4.2mm
D-20-0265 Ø 5.0mm
175mm

D-20-0266 Ø 2.7mm
D-20-0267 Ø 3.2mm
D-20-0268 Ø 3.7mm
D-20-0269 Ø 4.2mm
D-20-0270 Ø 5.0mm
175mm

7mm
10mm
13mm
15mm
18mm
20mm

7mm
10mm
13mm
15mm
18mm
20mm



Імплантологія
Implantologie

Implantologie
Implantoloia

SINUS LIFT

Concave Tip Sinus Lift Osteotomes - Offset

A conventional osteotomy is made to the floor of the sinus. The Sinus Osteotome is inserted into the osteotomy and gently tapped apically to separate and lift the cortical bone at the sinus floor 2mm-4mm.



Concave Tips Allow
introduction of Graft Material



Adjustable
Depth Stops



Tips Marked
8-20 mm



D-20-0271
Tip: 5.0 mm



D-20-0272
Tip: 4.5 mm



D-20-0273
Tip: 3.8 mm



D-20-0274
Tip: 3.1 mm



D-20-0275
Tip: 2.6 mm

SINUS 1981

Імплантологія
Implantologie

Implantologie
Implantoloia

SINUS LIFT

Concave Tip Sinus Lift Osteotomes - Straight

A conventional osteotomy is made to the floor of the sinus. The Sinus Osteotome is inserted into the osteotomy and gently tapped apically to separate and lift the cortical bone at the sinus floor 2mm-4mm.

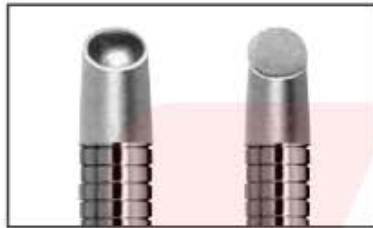

Concave Tips Allow introduction of Graft Material



Adjustable Depth Stops



Tips Marked 8-20 mm



D-20-0276
Tip: 5.0 mm



D-20-0277
Tip: 4.5 mm



D-20-0278
Tip: 3.8 mm



D-20-0279
Tip: 3.1 mm



D-20-0280
Tip: 2.6 mm

SINCE 1931



Імплантологія
Implantologie

Implantologie
Implantologia

SINUS LIFT

Sinus Osteotomes For Surgical Guides
Extended Length Osteotomes For Surgical Guides



Adjustable
Depth Stops

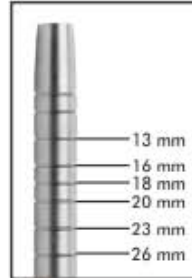

Length & Markings
Accommodate
Surgical Guide
Tubes



D-20-0281
Tip: 6.0 mm



D-20-0282
Tip: 5.0 mm



D-20-0283
Tip: 4.3 mm



D-20-0284
Tip: 3.5 mm



D-20-0285
Tip: 2.0 mm

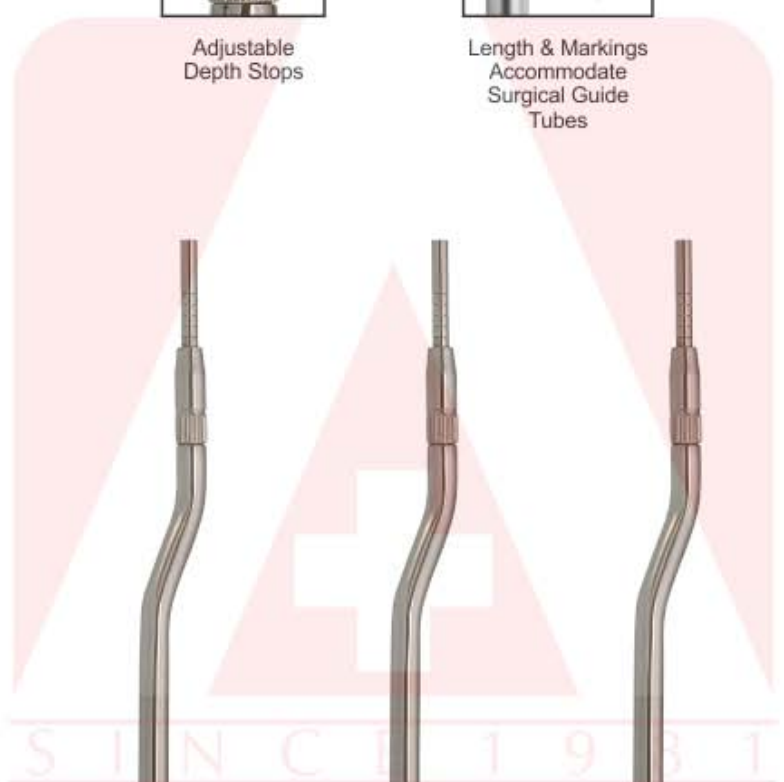

Імплантологія
Implantologie

Implantologie
Implantologia

**Bone Spreading
Osteotomes For Tapered Implants**

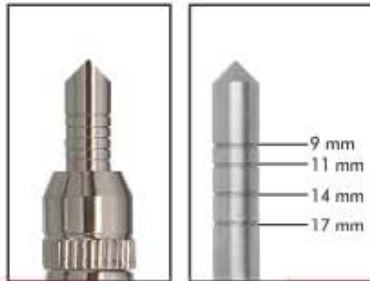

Adjustable
Depth Stops

Tapered Screw



D-20-0286
Tip: 5.1 mm



D-20-0287
Tip: 4.4 mm



D-20-0288
Tip: 3.8 mm



D-20-0289
Tip: 2.8 mm



D-20-0290
Tip: 2.3 mm

SINCE 1981



Імплантологія
Implantologie

Implantologie
Implantologia

BONE SPREADING

Bone Spreading Osteotomes
For Implant Placement In Soft Bone



Adjustable
Depth Stops

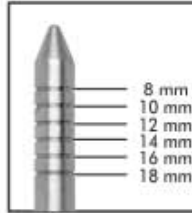

Tips Marked
8-18 mm

- 8 mm
- 10 mm
- 12 mm
- 14 mm
- 16 mm
- 18 mm



D-20-0291
Tip: 5.0 mm



D-20-0292
Tip: 4.5 mm



D-20-0293
Tip: 3.8 mm

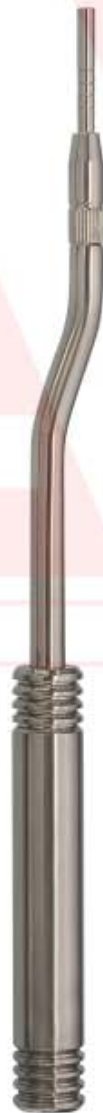

D-20-0294
Tip: 3.25 mm



D-20-0295
Tip: 2.7 mm



D-20-0296
Tip: 2.0 mm

Имплантологія
Implantologie

Implantologie
Implantoloia

BONE SPREADING
Bone Spreading Osteotomes
For Implant Placement In Soft Bone

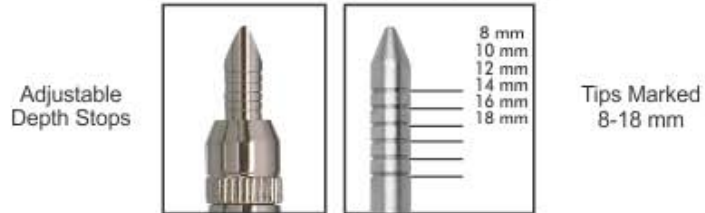

D-20-0297
Tip: 5.0 mm



D-20-0298
Tip: 4.5 mm



D-20-0299
Tip: 3.8 mm



D-20-0300
Tip: 3.25 mm



D-20-0301
Tip: 2.7 mm



D-20-0302
Tip: 2.0 mm



Description	Page #	Description	Page #
A			
ADAMS PLIERS FOR HOOKS AND BENDING WIRE	103	CALIBRATED PROBES	60-61
ADAMS WIRE BENDING PLIERS	106	CALIPER / CALIPERS RULE	91
ADERER CLAMP WIRE BENDING PLIER	103	CASTROVIEJO NEEDLE HOLDERS	83
ALLISON TISSUE FORCEPS	82	CASTROVIEJO SCISSORS	78
AMALGAM CARRIER (DOUBLE END)	90	CAULK BLACK'S CUTTING INSTRUMENTS	69
AMALGAM CARRIER (SINGLE END SYRINGE TYPE)	90	CAVITY FINDER EXPLORERS	61
AMALGAM CARRIER (SINGLE END)	90	CEMENT SPATULA DOUBLE ENDED	97
AMALGAM WELL STAINLESS STEEL	90	CHISELS	119-120
ANGLE BAND FORMING PLIER	105	CHISELS & GOUGES	86
ANGLE WIRE BENDING PLIERS	106	CHISELS / OSTEOTOMES	121-122
ANGLED DIRECT BOND BRACKET PLIERS T.C.	100, 102	CHOMPRET SYNDESMOTOME	58
ANILLOS FORCEPS	82	CLEOID/DISCOID WAX & MODELLING CARVERS	72
ANISWORTH SEPARATING PLIER	93	COHEN EXTRACTING FORCEPS	34
ANTKOVIK WAX KNIVES	85	COLLEGE TWEEZERS	75-76
APICAL FRAGMENT EJECTORS	58-59	COLUMBIA SCALERS	62
APICAL ROOT ELEVATORS	42, 44	COMPACTOR	117
APPLICATOR & AMALGAM CARRIERS	90	COMPACTOR / TAMPERS BONE GRAFTING INSTRUMENTS	117
APPLICATOR FOR CALCIUM HYDROXIDE PLACER	90	CONE SOCKET MIRROR HANDLES	75
APPLICATOR FOR CALCIUM HYDROXIDE PLACER WITH MINI SPATULA	90	CONTOURING PLIER	103
ARTHUR ROOTS SPLINTER FORCEPS	22	COTTON PLIERS - TWEEZERS	76-77
ARTICULATORS	112	CRANE PICK ROOT ELEVATORS	42, 44, 48
B			
BACKHAUS TOWEL CLAMP	82	CROWN REMOVER	94
BALSHI PACKER FILLING INSTRUMENTS	73	CROWN SCISSORS	79
BAND SEATER AUTO CLEAVABLE	99	CRYER EXTRACTING FORCEPS	31
BARNHART UNIVERSAL CURETTES	67	CRYER ROOT ELEVATORS	42-45, 50
BARRYROOT ELEVATORS	57	CRYER-WHITE ROOT ELEVATORS	49
BASINS FOR BONE	116	CURETTE OF LUCAS	85
BEERENDONK GAUGE	91	D	
BEIN ROOT ELEVATORS	38, 47	DECIMAL SPRING CALIPER	91
BENDING FOR ROUND SQUARE PLIER	104	DELUX BOLEY GAUGE	91
BENDING PLIER	103	DELUXE BRACKET HOLDER TWEEZERS	96
BERTEN ROOT ELEVATORS	38, 53	DELUXE BRACKET HOLDER	96
BIRD BEAK PLIER	103	DENHARD RETRACTORS - MOUTH GAGS	87
BIRD VEAK PLIER	100	DENTAL SYRINGES	92
BLACK WAX & MODELLING CARVERS	72	DETROIT PLUGGERS / CONDENSERS	73
BLACK'S CUTTING INSTRUMENTS	69	DIDNER MATRIX RETAINERS	89
BOLEY GAUGE	91	DIRECT BOND BRACKET HOLDER TWEEZERS	96
BONE BRACKET GAUGE	91	DIRECT BOND BRACKET REMOVER T.C.	100
BONE FILE	85	DIRECT BONDING BRACKET HOLDERS	96
BONE MILL	116	DIRECT BONDING BRACKET REMOVER	102
BONE MORSELIZER	116	DIRECT BRACKET REMOVER T.C.	102
BONE SCRAPER	119	DISTAL BENDER	99
BONE SPOON / PACKER	117	DISTAL END CUTTER SAFETY HOLD PLIER T.C.	102
BONE SPREADING OSTEOTOMES	126-127-128	DOUBLE ROUNDED JAW BENDING PLIERS	103
BRACKET HOLDER TWEEZERS	96	E	
BRACKET PLACER TWEEZERS	96	EASY BONE MANUAL	116
BRACKET TWEEZERS SLOT ALIGNER	96	EASY ECESS TWEEZERS	96
BREDALL BLACK'S CUTTING INSTRUMENTS	69	ELASTIC SEPARATING PLIER	93
BREWERSEPARATING PLIER	93	ELLIOT MATRIX RETAINERS	89
BUFFALO PLASTER SPATULA	84	ENDED CHEEK RETRACTORS	87
BUR CHANGER HEXAGONAL KEY	95	ENDODONTIC SPREADERS	64
BUR CHANGER SQUARE KEY	95	ENDODONTIC TWEEZERS	75
BURNISHERS-DOUBLE END	68	ERMERT WAX KNIVES	85
BURNISHERS-SINGLE END	68	EXCAVATORS	70
C			
CALCIUM HYDROXIDE PLACEMENT	94	EXECT BRACKETER HOLDER TWEEZERS	96
		EXPLORERS	61
		EXTRACTING FORCEPS (AMERICAN PATTERN)	23-36



Description	Page #	Description	Page #
EXTRACTING FORCEPS (ENGLISH PATTERN).....	01-19		
F		I	
FAHAMENSTOCK WAX KNIVES	85	HYLIN ROOT ELEVATORS	46
FAHNENSTOCK (SMALL) KNIFE AND SPATULA	84	IMPLANTOLOGY	118-117
FALCON BEAK CONTOURING PLIER.	103	IMPRESSION TRAYS-STAINLESS STEEL	110-111
FARABEUFR RETRACTORS	88	INTRALIGAMENTAL ANESTHESIA SYRINGE	92
FELSCH EXTRACTING FORCEPS	19	IPC INTERPROXIMAL WAX & MODELLING CARVERS	72
FILLING INSTRUMENTS.....	68,73	IPC-A (ANGLED) WAX & MODELLING CARVERS.....	72
FINE IRIS SCISSORS	79	IRIS SCISSORS.....	78
FLAGG TWEEZERS	76	IVORYSEPARATING PLIER.....	93
FLASHING CROWN REMOVER	94	IWANSON GAUGE	91
FLAT NOSE PLIER FOR SCREW POINTS.....	108	JACQUETTE SCALERS	62
FLAT NOSE PLIER T.C.....	100	J	
FLAT NOSE PLIERS.....	108	JENNINGS RETRACTORS - MOUTH GAGS.....	87
FLOHR ROOT ELEVATORS	40-45, 47, 51	JOHNSON CONTOURING PLIERS	107
FORCEPS FOR CHILDREN	21	JOHNSON PLIERS FOR CROWN BAND CONTOURING.....	103
FRAHM BLACK'S CUTTING INSTRUMENTS.....	69	K	
FREVERT CONTOURING PLIERS	107	KELLS EXTRACTING FORCEPS	30
FRIEDMAN ROOT ELEVATORS	40	KELLY HAEMOSTATIC FORCEPS.....	81
FRONT LOAD TYPE DENTAL SYRINGES	92	KOPP ROOT ELEVATORS	53
FULLY AUTOMATIC CROWN REMOVER	94	L	
G		LADMORE PLASTIC FILLING INSTRUMENTS	70
GARDNER CHISELS	86	LECLUSE ROOT ELEVATORS	55
GLICK ROOT CANAL EXCAVATORS.....	63	LEGRA MOLT	85
GOLDMAN FOX OPERATING SCISSORS	78	LEGRA SELDIN	85
GOLDMAN-FOX PROBES SINGLE END	60	LESSMANN WAX KNIVES	85
GOLDMAN-FOX PROBES-DOUBLE END	61	LEVY BLACK'S CUTTING INSTRUMENTS	69
GORDON CONTOURING PLIERS.....	107	LINDO-LEVIEN ROOT ELEVATORS	40, 46
GOSLEE CONTOURING PLIERS	107	LOCKING TWEEZERS	75
GRACEY INCISORS & CUSPIDS	66	LOOP FORMING PLIER	104
GRACEY-CURETTES.....	66	LUCAS CHISELS	86
GRAFT MATERIAL SPOON	117	LUCAS GOUGES	86
GRAFT PACKER CONCAVE	117	M	
GRAFT PACKER.....	117	MANUAL BONE MILL, HOLDING & DRILLING FORCEPS	116
GREGG PLASTIC FILLING INSTRUMENTS	70	MATHIEU ELATIC TIP	109
GRITMAN KNIFE	84	MATHIEU LIGATURE PLACING	109
GUM SCISSORS	80	MATHIEU MEDIUM SPRING (T.C. TIP) GOLD HANDLE	109
GUN LOAD TYPE DENTAL SYRINGES	92	MATHIEU NARROW SPRING(T.C. TIP) GOLD HANDLE	109
GUYER CROWN REMOVERS	94	MATHIEU NEEDLE HOLDERS	83, 109
H		MATRIX IVORY	89
HAEMOSTATIC FORCEPS	81	MATRIX RETAINERS & BANDS, STRIP HOLDER CLIPS.....	89
HALSTED MOSQUITO BABY HAEMOSTATIC FORCEPS.....	81	MATRIX RETAINERS IVORY	89
HALSTED MOSQUITO HAEMOSTATIC FORCEPS	81	MAYO HEGER NEEDLE HOLDERS	83
HARD WIRE CUTTER	104	MAYO SCISSORS	79
HARRIS EXTRACTING FORCEPS	25	MCCALLS SCALERS	62
HEAT TRANSFER CARRIER	64	MEAD EXTRACTING FORCEPS	19
HEAVY DUTY BAND PUSHER.....	99	MEAD ROOT ELEVATORS	56
HEIDBRINK APICAL FRAGMENT EJECTORS	59	MERIAM TWEEZERS.....	76
HEIDBRINK ROOT ELEVATORS	40, 51	MICHIGAN PROBES SINGLE END	60
HEMOSTATS FORCEPS	82	MILLER ROOT ELEVATORS	41, 43, 45
HENAHAN EXTRACTING FORCEPS	34	MILLS-SINUS LIFT INSTRUMENTS	114
HOLLENBACK BLACK'S CUTTING INSTRUMENTS	69	MINI GAUGE.....	91
HOLLENBACK PLUGGERS / CONDENSERS.....	73	MINI MATHIEU NEEDLE HOLDER	109
HOLLOW STAINLESS MIRROR HANDLES	75	MINI PIN AND LIGATURE CUTTER TC	101
HOOK CRIMPING PLIERS T.C	102	MINNESOTA UNIVERSITY RETRACTORS	88
HULL EXTRACTING FORCEPS	30		



Description	Page #	Description	Page #
MISCELLANEOUS PRODUCTS	95	POLAR BEAR ICE INSTRUMENTS	99
MISHCH-SINUS LIFT INSTRUMENTS	113	POSIGRIP ARTICULATING PAPER FORCEPS	77
MIXING SPATULAS	74	POSITIVE POSITIONER	99
MORRELL CROWN REMOVER SET	94	PROBER & EXPLORERS.....	65
MORRISON ROOT SCREWS	59	PROBES-DOUBLE END	61
MORTPLUGGERS / CONDENSERS	73	PROBEX CALIBRATED PROBES	60
MOUTH GAG MOLT	88	PROBEX PROBES-DOUBLE END	61
MOUTH MIRROR RHODIUM	75	PROBEX WILLIAMS CALIBRATED PROBES	60
		PROBEX WILLIAMS PROBES-DOUBLE END	61
		PROBEX PROBES-DOUBLE END	61
		PRONG CLASP ADJUSTABLE PLIER TC	101
N		Q	
NABERSCALIBRATED PROBES	60	QUINBY GUM SCISSORS.....	80
NANCE LOOP CLOSING PLIER, FOR BENDING	104		
NEEDLE HOLDERS	83, 109		
NEVIUS EXTRACTING FORCEPS	29, 34		
O		R	
OPERATING SCISSORS	78-79	RALK ROOTS SPLINTER FORCEPS	22
ORTHO BAND PUSHER SCALER.....	97	RATCHET.....	119
ORTHO INSTRUMENT	98-99	RETRACTOR SELDIN.....	88
ORTHO LIGATURE DIRECTOR SINGLE ENDED	97	RETRACTORS - MOUTH GAGS.....	87-88
ORTHO LIGHT BAND PUSHER SCALER	97	REYNOLDS CONTOURING PLIERS	107
ORTHO LIGHT DOUBLE ENDED SCALE.....	97	ROCHESTER FORCEPS	82
ORTHO LIGHT LIGATURE DIRECTOR DOUBLE ENDED	97	ROOT CANAL EXPLORER	65
ORTHO LIGHT SCALER DOUBLE ENDED	98	ROOT CANAL PLUGGERS	65
ORTHO LIGHT SCALER HEAVY	98	ROOT CANAL SPREADERS	64
ORTHO LIGHT SCALER SINGLE ENDED.....	97	ROOT CANAL SPREADERS-STAINLESS STEEL	63
ORTHO LIGHT SCALER	98	ROOT ELEVATORS	37-57
ORTHODONTICS INSTRUMENTS	96-99	ROOTS SPLINTER FORCEPS	22
ORTHOLITE LIGATURE DIRECTOR SCALER.....	97	ROSER-KÖNIG RETRACTORS - MOUTH GAGS	87
OSSEOUS CHISELS / COUPLAND ROOT ELEVATORS.....	50	ROUND AND CONCAVE PLIER.....	104
OSTEOMETER MEASURING FORCEPS.....	91	ROUTURIER WISDOM EXTRACTING FORCEPS	20
OSTEOTOMES	120	RUBBER DAM FRAME.....	93
		RUBBER-DAM PUNCH CLAMP FORCEPS.....	93
P		S	
PALMER SEPARATING PLIER.....	93	SCALERS	62?
PARMLY EXTRACTING FORCEPS	27	SCHLEMMER ROOT ELEVATORS	54
PARTSCHCHISELS	86	SCHURE BAND SEATER.....	98
PARTSCHGOUGES	86	SCHWARZ ARCH AND SPRING BENDING PLIERS	106
PEESO COLLAR PLIERS.....	105	SELDIN ROOT ELEVATORS	42-45, 49
PEESO CROWN STRETCHING PLIERS.....	105	SELF ASPIRATING DENTAL SYRINGES	92
PEESO PLIER FLAT AND ROUND	105	SELF ASPIRATING SYRINGE.....	92
PEET COTTON PLIERS	77	SERIES UNIVERSAL CURETTES	67
PERIOTOME HANDLE BLADES & RATCHET	119	SHERMAN PACKER FILLING INSTRUMENTS	73
PERRY TWEEZERS	75-76	SHOOSHAN BLACK'S CUTTING INSTRUMENTS.....	69
PIKOS-SINUS LIFT INSTRUMENTS	113	SICKLES UNIVERSAL CURETTES	67
PIN AND LIGATURE CUTTER T.C	102	SIMPLE STEM MIRROR HANDLES	75
PIN HOLDING PLIER T.C	100	SINUS LIFT CONCAVE TIP OSTEOTOMES	123-124
PIN ROUGHENING-CUTTING AND BENDING PLIER	105	SINUS LIFT INSTRUMENTS	113-115
PLACEMENT AND REMOVAL OF ARCH WIRES.....	103	SINUS LIFT OSTEOTOMES FOR SURGICAL GUIDES	125
PLACEMENT CROWN REMOVERS	94	SINUS WINDOW BONE TAMPERS	117
PLASTER CUTTING KNIFE LARGE BUFFALO TYPE	84	SINUS-FREER CU LIFT INSTRUMENT	115
PLASTER CUTTING PLIER	84	SINUS-FREER LIFT INSTRUMENT	115
PLASTER SPATULA FLEXIBLE	84	SLIPPER TWEEZERS	96
PLASTIC FILLING INSTRUMENTS	70	SMITH PLUGGERS / CONDENSERS.....	73
PLASTIC FILLING INSTRUMENTS & EXCAVATORS	70	SOLDERING TWEEZERS & FORCEPS	77
PLASTIC FILLING INSTRUMENTS	71	SOLID STAINLESS MIRROR HANDLES	75
PLIERS FOR ORTHODONTICS & PROSTHETICS.....	100-108	STANDARD ARTICULATING PAPER FORCEPS.....	77
PLIERS, MIXING SPATULAS AND PLASTER		STANDARD EXTRACTING FORCEPS	34
CUTTING KNIVES	84	STANDARD LIGATURE CUTTER TC.....	101
PLUGGERS / CONDENSERS.....	73		



Description	Page #	Description	Page #
STERILIZING FORCEPS.....	82	Y	
STEWART PROBE ROOT CANAL EXCAVATORS	63	YOUNG WIRE BENDING PLIER.....	107
STIEGLITZ ROOTS SPLINTER FORCEPS	22		
STIEGLITZ TWEEZERS	77		
STOCKESSEPARATING PLIER	93		
SURGICAL SCISSORS	78		
SUTURE SCISSORS	79		
SWING EXTRACTING FORCEPS	33		
T			
TAPER FILLING INSTRUMENTS.....	73		
THOMSON ROOT ELEVATORS	54		
TISSUE PUNCH	118		
TISSUE PUNCHES STAINLESS STEEL.....	118		
TIVATE COIL SPRING	97		
TOFFLEMIRE MATRIX RETAINERS.....	89		
TOFFLEMIRE-JUNIOR MATRIX RETAINERS	89		
TOFFLEMIRE-UNIVERSAL MATRIX RETAINERS	89		
TOMAS EXTRACTING FORCEPS	29		
TORQUE WRENCHES & DRIVERS.....	119		
TRICO PLASTIC FILLING INSTRUMENTS	71		
TRYFUS CROWN FORMING PLIER.....	107		
TWEED LOOP FORMING PLIER T.C.....	100		
TWIEL-ON ELASTIC MODULE INSTRUMENT.....	98		
U			
UNIVERSAL CURETTES.....	67		
USA MODELL CONTOURING PLIERS	107		
V			
V BEND STOP PLIER TC.....	101		
W			
WALLS BLACK'S CUTTING INSTRUMENTS	69		
WARD BLACK'S CUTTING INSTRUMENTS.....	69		
WARD PLUGGERS / CONDENSERS	73		
WARWICK-JAMESROOT ELEVATORS	50		
WASHINGTON CALIBRATED PROBES	60		
WASHINGTON PROBES-DOUBLE END	61		
WAX & MODELLING CARVERS	72		
WAX KNIVES, BONE FILES & CURETTES.....	85		
WAX MIXING SPATULAS	74		
WEINGART UTILITY PLIER TC.....	101		
WEITLANDER RETRACTORS - MOUTH GAGS	87		
WHITE ROOT ELEVATORS	38, 49		
WHO CALIBRATED PROBES	60		
WILLIAMS CALIBRATED PROBES	60		
WILLIAMS PROBES SINGLE END	60		
WINTER ROOT ELEVATORS.....	56		
WISDOM EXTRACTING FORCEPS	20		
WITZEL ROOTS SPLINTER FORCEPS	22		
WOODSON PLASTIC FILLING INSTRUMENTS	71		
WOODWARD EXTRACTING FORCEPS	35		
X			
X-RAY HOLDER CLIP SINGLE	95		
X-RAY HOLDER SET.....	95		

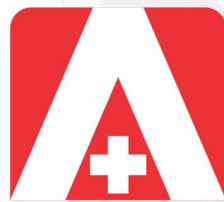

Allegro Surgical Corporation

Manufacturers & Exporters of Surgical, Dental Instruments & Holloware

Head Quarter:

ALLEGRO SURGICAL CORP.
Bismillah Chowk, Pasrou Road,
SIALKOT - 51310 PAKISTAN.

Unit:

Jinnah Islamia College Road,
SIALKOT - 51310 PAKISTAN.

Tele No: +92-52-4596242, 4583234

Fax No: +92-52-4597345

E-mail : info@allegro.com.pk

URL : www.allegro.com.pk