



EAR, NOSE, THROAT SURGERY





EAR SPECULA, DIAGNOSTIC PRODUCTS

Ohrspekula, Diagnostikprodukte
Espéculos Auriculares, produits diagnostiques

Spéculms Auriculares, Prodotti diagnostici
Specoli Auricolari, Productos de diagnóstico

- 2.0
- 3.0
- 3.5
- 4.0
- 4.5
- 5.0
- 6.0
- 6.5
- 7.0
- 7.5 mm Ø



BOUCHERON
 LG12-001-001 Set of 4
 LG12-002-002 3.5 mm
 LG12-003-003 4.5 mm
 LG12-004-004 5.5 mm
 LG12-005-005 6.5 mm



PLOITZER
 LG12-006-001 Set of 4
 LG12-007-002 2 mm
 LG12-008-003 3 mm
 LG12-009-004 4 mm
 LG12-010-005 5 mm



HARTMANN
 for children
 LG12-011-001 Set of 3
 LG12-012-002 2 mm
 LG12-013-003 3.5 mm
 LG12-014-004 5 mm

- 2.0
- 3.0
- 3.5
- 4.0
- 4.5
- 5.0
- 6.0
- 6.5
- 7.0
- 7.5 mm Ø



HARTMANN
 Set of 4, For Adults
 LG12-015-001 4.0 mm
 LG12-016-002 5.0 mm
 LG12-017-003 6.0 mm
 LG12-018-004 7.5 mm

- LG12-019-001 Ø 2 mm ○
- LG12-020-002 Ø 2.5 mm ○
- LG12-021-003 Ø 3 mm ○
- LG12-022-004 Ø 4 mm ○
- LG12-023-005 Ø 5 mm ○

Hartmann
 Eustachian Catheters





TUNING FORKS

Stimmgabeln
Diapasones

Diapasons
Diapason



**HARTMANN /
FRENCH**
LG12-024-128
C 128



LUCAE
LG12-025-010
C 128
Variable up to h
(= Engl. B)



HARTMANN
LG12-026-010
C 128
Variable up to h
(= Engl. B)

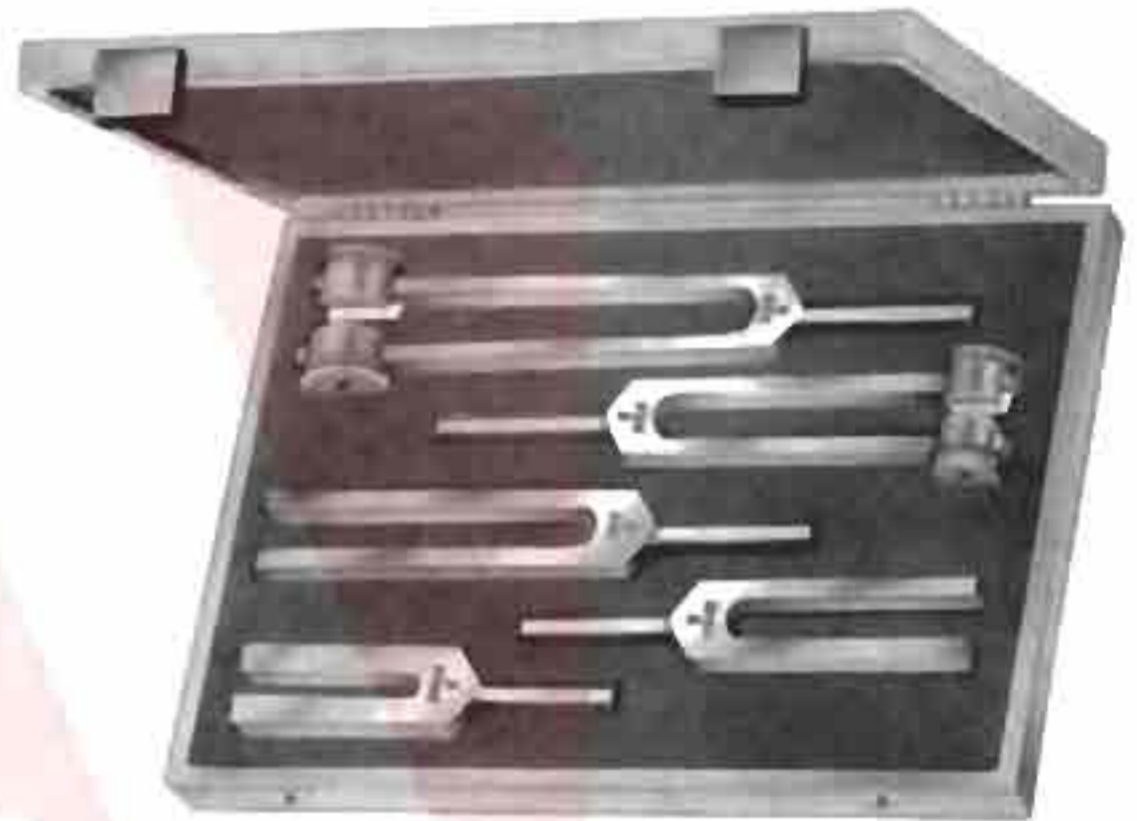

LG12-027-000 = Set 5

- LG12-028-0128 C 128
- LG12-029-0256 C 256
- LG12-030-0512 C 512
- LG12-031-1024 C 1024
- LG12-032-2048 C 2048

Aluminum

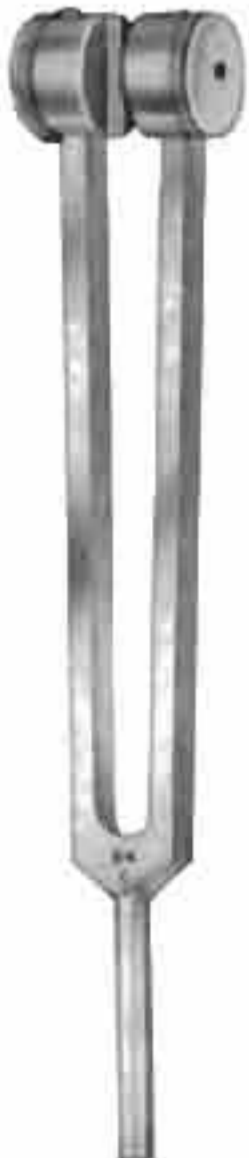

LG12-033-064
C 64



LG12-034-128
C 128



LG12-035-256
C 256



LG12-036-512
C 512



LG12-037-1024
C 1024



LG12-038-2048
C 2048



LG12-039-4096
C 4096



TUNING FORKS

Stimmgabeln
Diapasones

Diapasons
Diapason

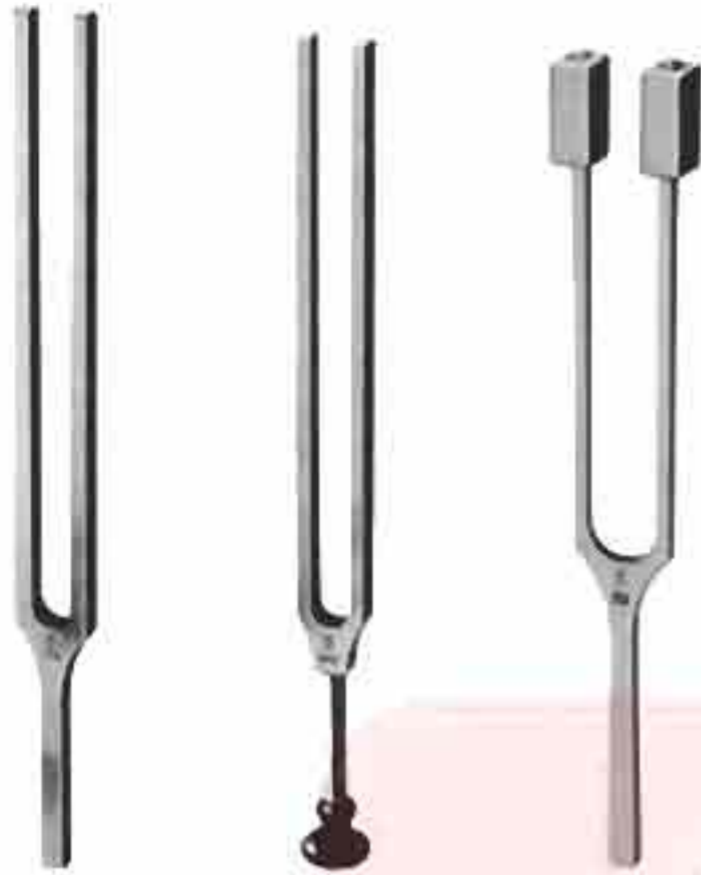

HARTMANN

LUCAE

HARTMANN-FRENCH

C ²	16			LG12-052-016
C ¹	32			LG12-053-032
C	64			LG12-054-064
C	128 c	LG12-040-128	LG12-046-128	LG12-055-128
C ¹	256 c	LG12-041-256	LG12-047-256	LG12-056-256
C ²	512 c ¹	LG12-042-512	LG12-048-512	
C ³	1024 c ¹	LG12-043-1024	LG12-049-1024	
C ⁴	2048 c ¹	LG12-044-2048	LG12-050-2048	
C ⁵	4096 c ¹	LG12-045-4096	LG12-051-4096	



HARTMANN
LG12-057-000 = Set 6

LUCAE
LG12-058-000 = Set 6

HARTMANN-FRENCH
LG12-059-000 = Set 7

LG12-060-128 128C
LG12-061-256 256C¹
LG12-062-512 512C²
LG12-063-1024 1024C³
LG12-064-2048 2048C⁴
LG12-065-4096 4096C⁵

LG12-066-128 128C
LG12-067-256 256C¹
LG12-068-512 512C²
LG12-069-1024 1024C³
LG12-070-2048 2048C⁴
LG12-071-4096 4096C⁵

LG12-072-016 16C²
LG12-073-032 32C²
LG12-074-064 64C
LG12-075-128 128C
LG12-076-256 256C¹



RYDEL-SEIFFER
LG12-077-001
C 65 / C 128
With Clamps = C 64
Without Clamps = C 128



LG12-078-001



KOENIG
LG12-079-001
A 109
Variable up to g



LG12-080-001
a¹ 109



TYMPANUM NEEDLE

Trommelfellnadeln,
Agujas Para Timpano,

Aiguilles Pour Le Tympan,
Aghi Per Timpano,



327-168-160 327-169-190



LUCAE
LG12-081-160
for children, 16 cm, 6 1/2"
LG12-082-190
for adults, 19 cm, 7 1/2"
Tympanum Perforators, bayonet-shaped
LG12-083-180
for children, 18 cm, 7"
Tympanum Perforator, bayonet-shaped,
handle 90 angled to the lancet



AGNEW
LG12-084-190
Tympanum Perforator, angular
19 cm, 7 1/2"



POLITZER
LG12-085-165
16.5 cm, 6 1/2"

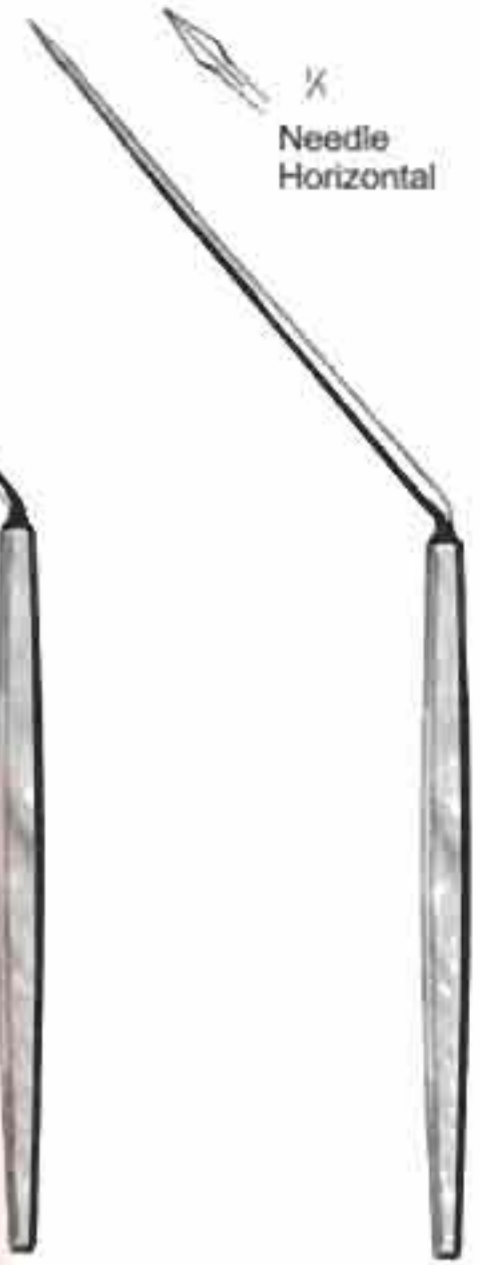

POLITZER
LG12-086-165
16.5 cm, 6 1/2"



POLITZER
LG12-087-160
16 cm, 6 1/2"



BUCK
LG12-088-150
15 cm, 6"



SEXTON
LG12-089-180
18 cm, 7"



SEXTON
LG12-091-170
17 cm, 6 3/4"



GERZOG-SEXTON
LG12-092-170
17 cm, 6 3/4"



POLITZER
LG12-093-160
16 cm, 6 1/2"



TYMPANUM NEEDLE, EAR CURETTES

Trommelfellnadeln, Ohrküretten
Agujas Para Tímpano, Curettes Auriculaires

Aiguilles Pour Le Tympan, Curettes Auriculaires
Aghi Per Timpano, Cuette Auricolari



BARBARA
16 cm, 6 1/4"

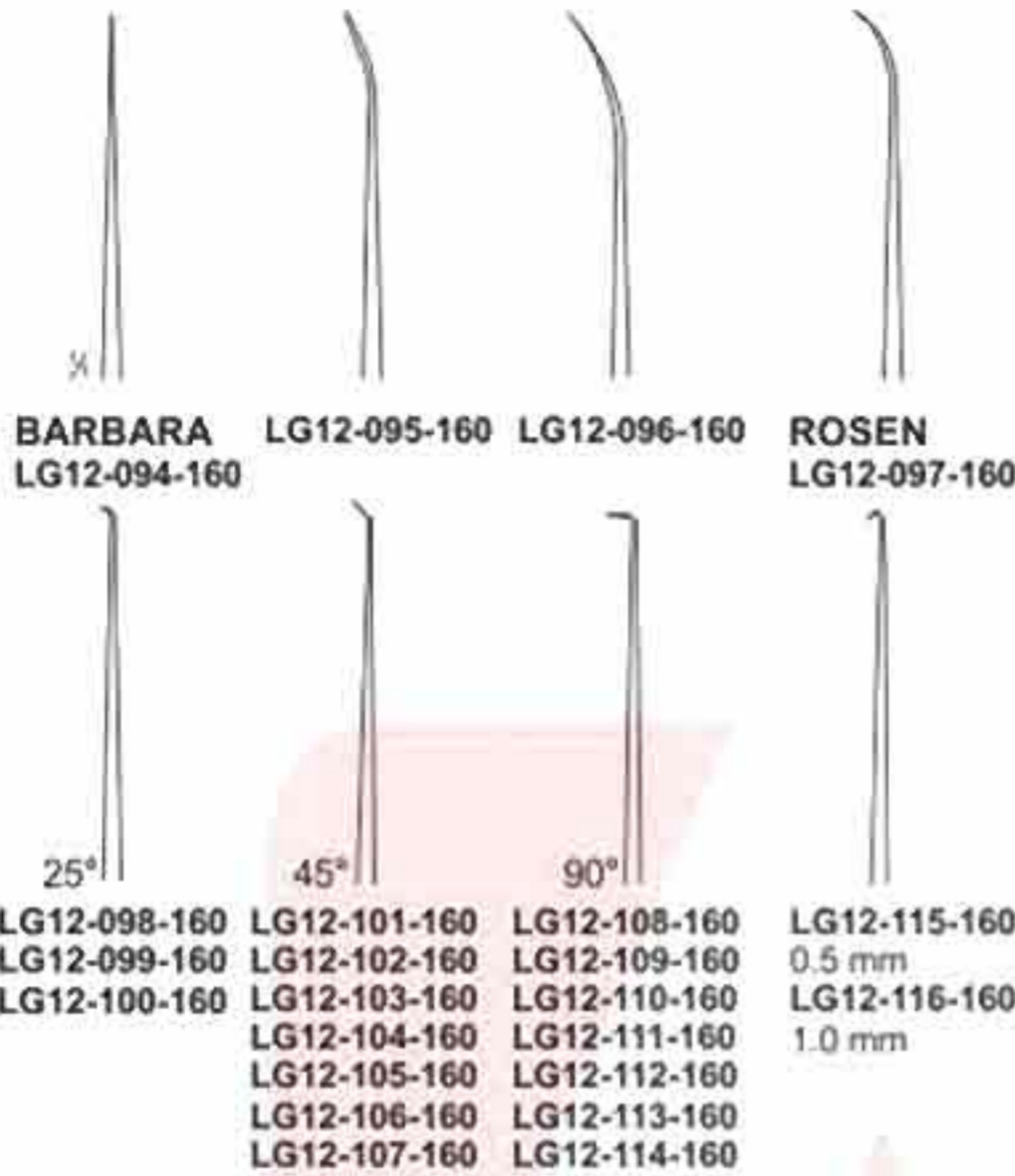

LEMPERT
17 cm, 6 3/4"

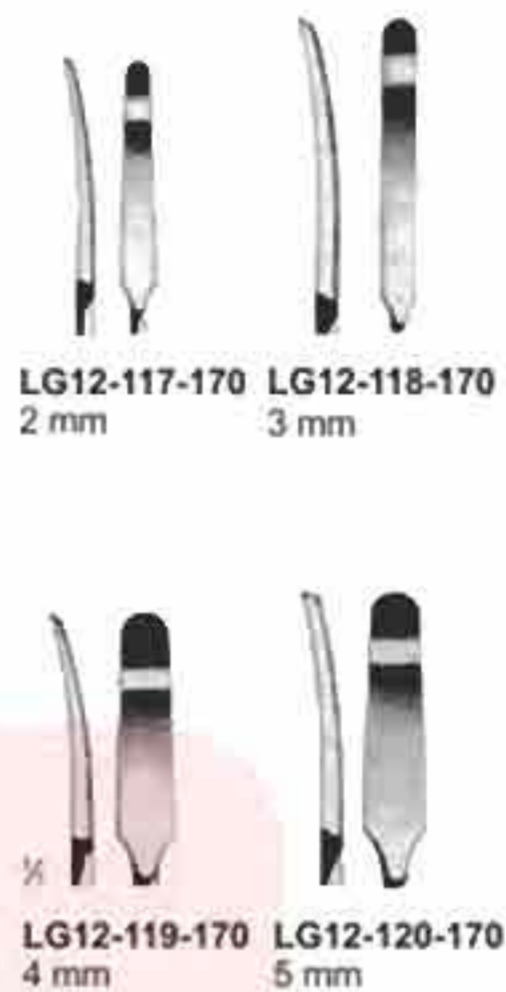

SHAPLEIGH
13 cm, 5 1/4"

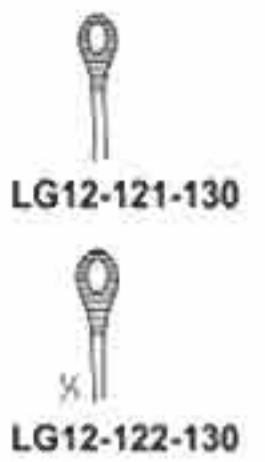

BUCK
16.5 cm, 6 1/2"

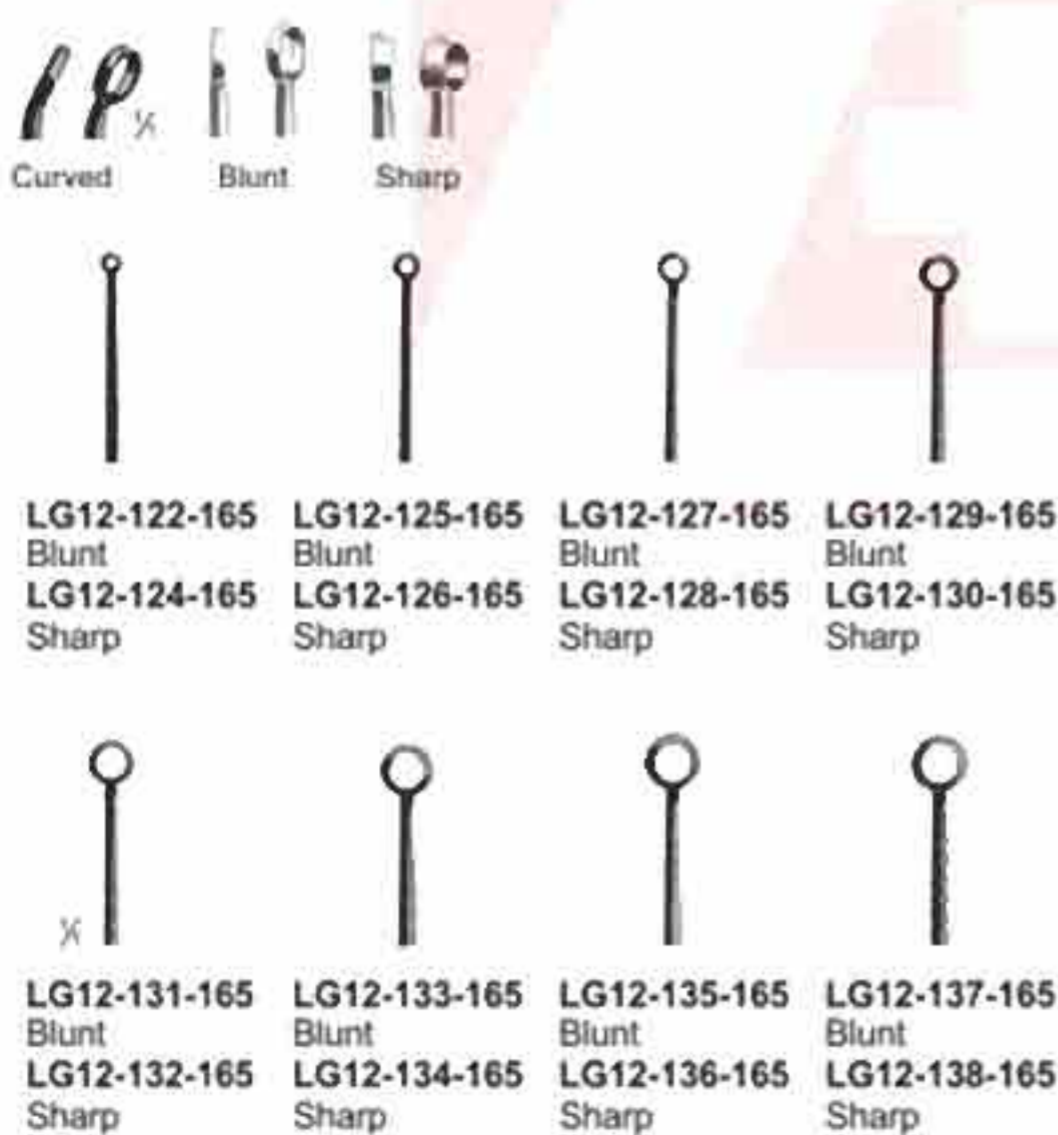

LANGENBECK
LG12-139-130
13 cm, 5 1/4"



BARTH
LG12-140-180
18 cm, 7"



JANDEN
LG12-141-150
15 cm, 6"



EAR HOOKLETS, TYMPANUM NEEDLE

Ohrhäkchen, Trommelfellnadeln
Ganchitos Auriculares, Agujas Para Tímpano

Crochets Auriculaires, Aiguilles Pour Le Tympan
Uncini Auricolari, Aghi Per Timpano



ROSEN
16 cm, 6 1/4"

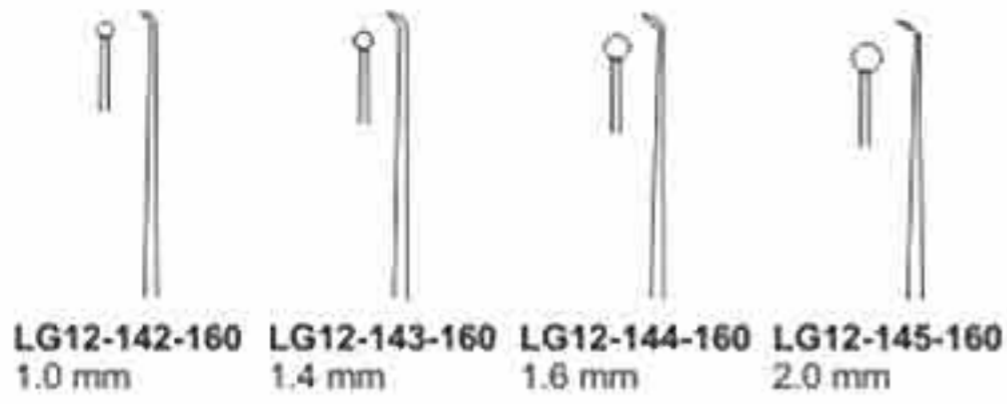

LG12-142-160 1.0 mm
LG12-143-160 1.4 mm
LG12-144-160 1.6 mm
LG12-145-160 2.0 mm

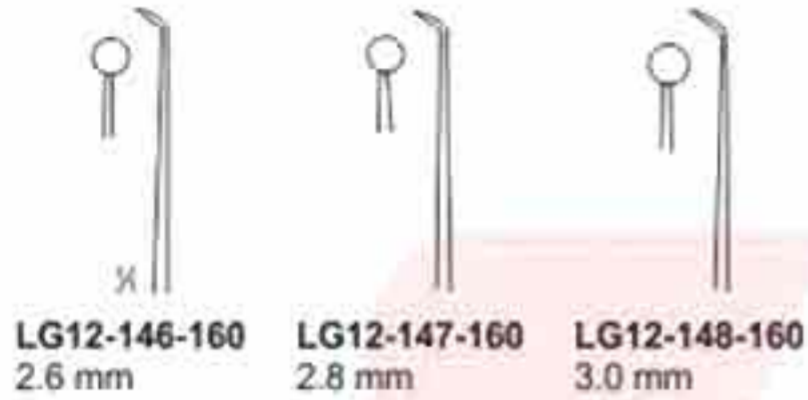

LG12-146-160 2.6 mm
LG12-147-160 2.8 mm
LG12-148-160 3.0 mm



PLESTER
16 cm, 6 1/4"

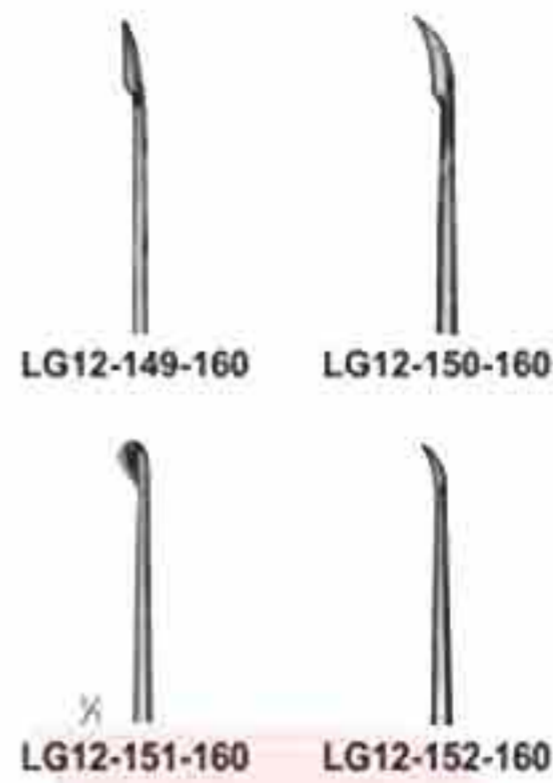

LG12-149-160
LG12-150-160
LG12-151-160
LG12-152-160



SCHUKNECHT
16 cm, 6 1/4"

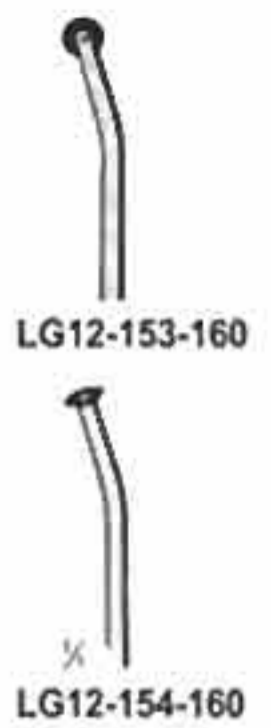

LG12-153-160
LG12-154-160



SCHUKNECHT
LG12-155-160
16 cm, 6 1/4"



SCHUKNECHT
LG12-156-160
16 cm, 6 1/4"



BILLEAU
16.5 cm, 6 1/2"



LG12-157-165
LG12-158-165
LG12-159-165



SNELLEN
16.5 cm, 6 1/2"



LG12-160-165
LG12-161-165



EAR HOOKLETS, TYMPANUM NEEDLE

Ohrhäkchen, Trommelfellnadeln
Ganchitos Auriculares, Agujas Para Tímpano

Crochets Auriculaires, Aiguilles Pour Le Tympan
Uncini Auricolari, Aghi Per Timpano



GROSS
LG12-162-165
16.5 cm, 6 1/2"



HARTMANN
LG12-163-165
16.5 cm, 6 1/2"



ZAUFAL
LG12-164-165
16.5 cm, 6 1/2"



WAGENER
14 cm, 5 1/2"

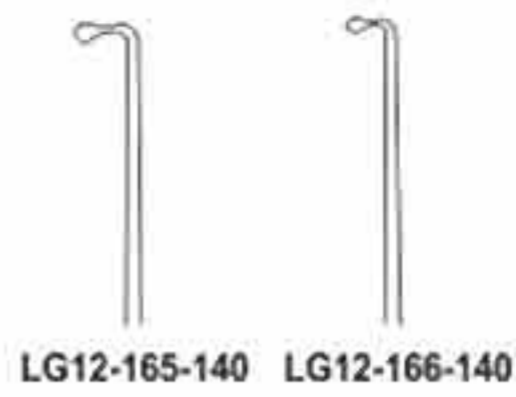

LG12-165-140 LG12-166-140

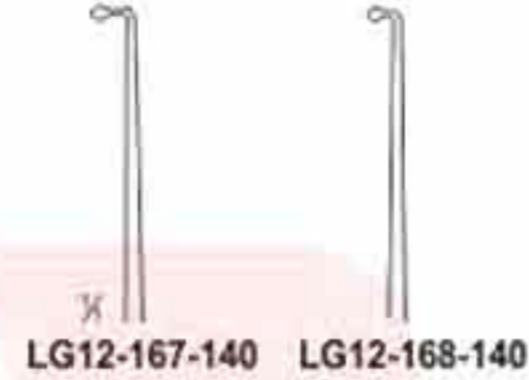

LG12-167-140 LG12-168-140



LUCAE
14 cm, 5 1/2"

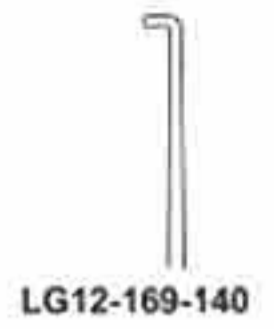

LG12-169-140

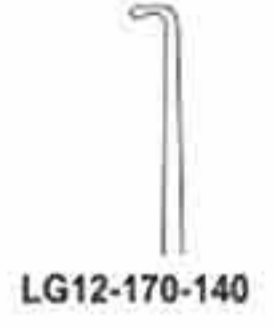

LG12-170-140

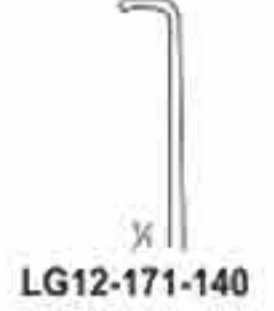

LG12-171-140



FISCH
18 cm, 7"

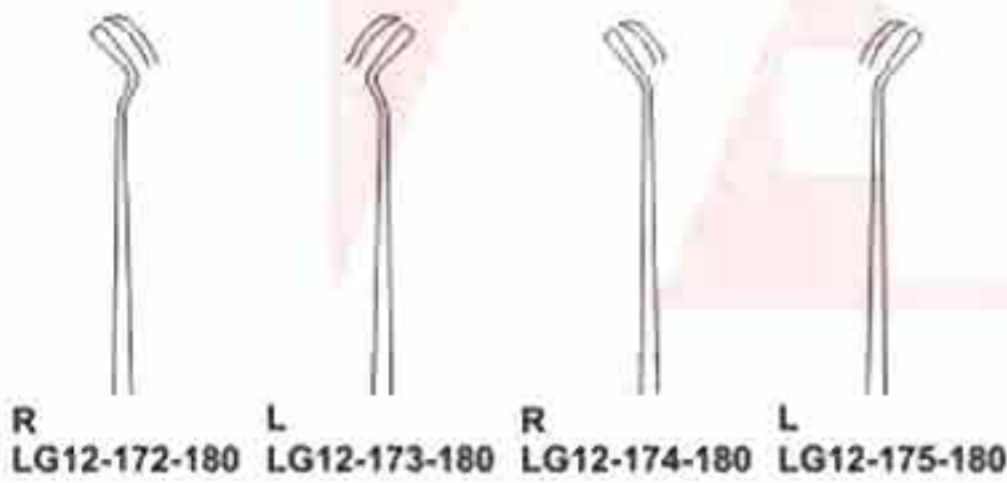

R LG12-172-180 L LG12-173-180 R LG12-174-180 L LG12-175-180



ROSEN
18 cm, 7"

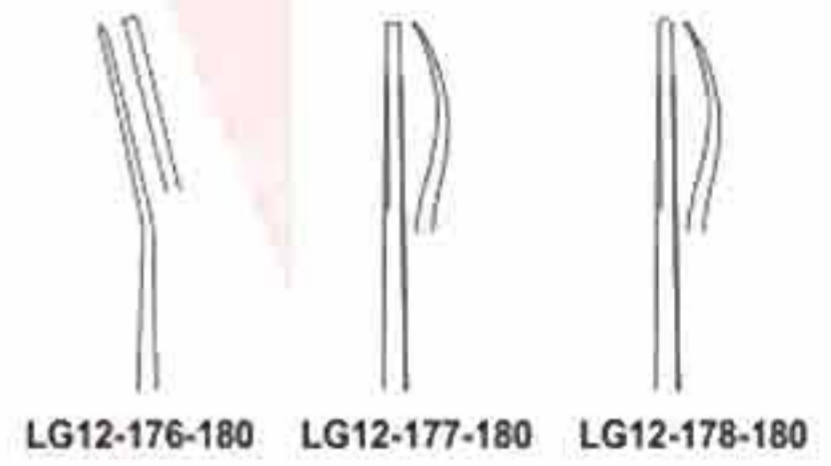

LG12-176-180 LG12-177-180 LG12-178-180

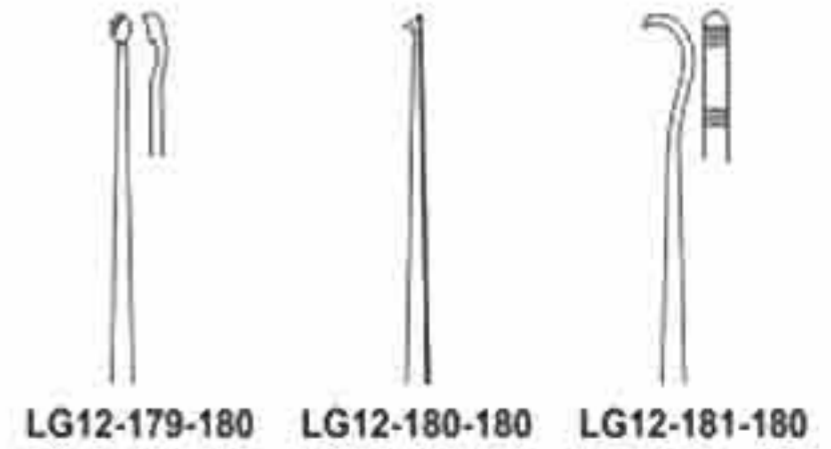

LG12-179-180 LG12-180-180 LG12-181-180



EAR POLYPUS FORCEPS, EAR SYRINGES

Ohrpolypenzangen, Ohrspritzen

Pinzas Para Pólipos Auriculares, Seringues à oreilles

Pinces Pour Polypes Auriculaires, Siringhe per orecchi

Pinze Per Polipi Auricolari, Jeringas para el oído

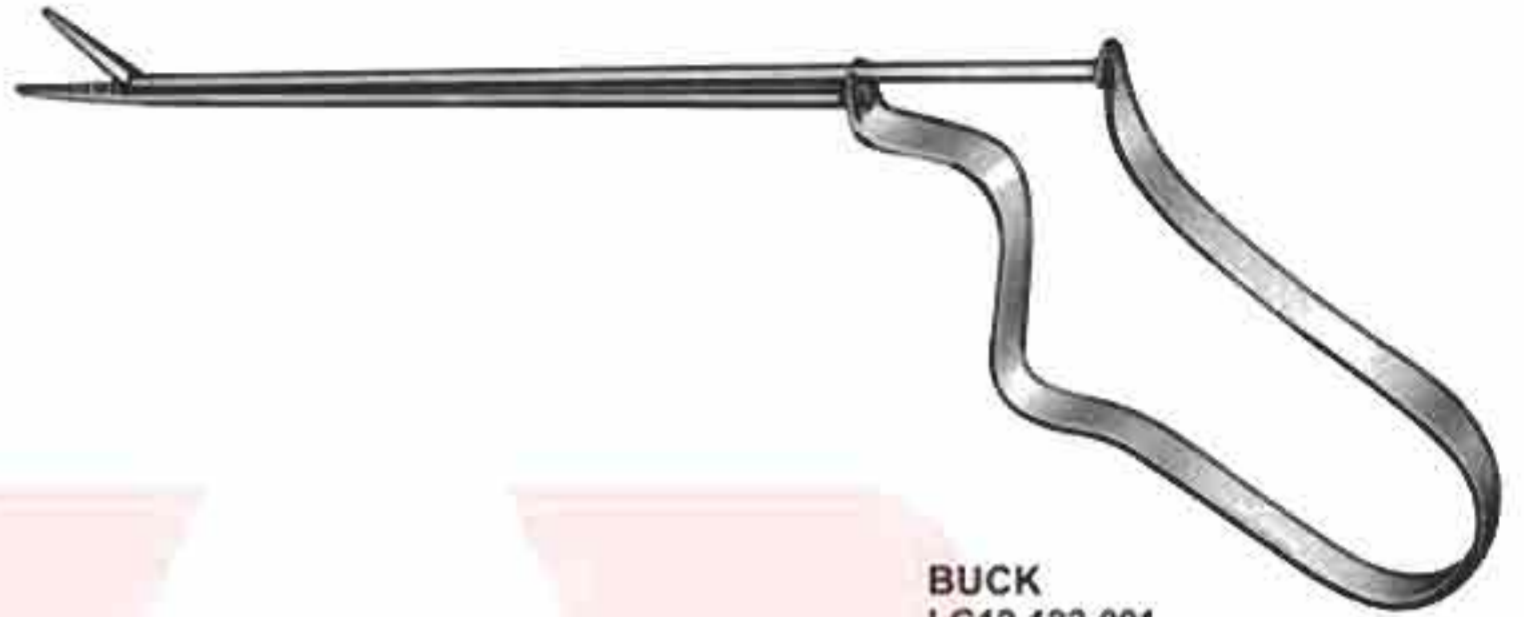
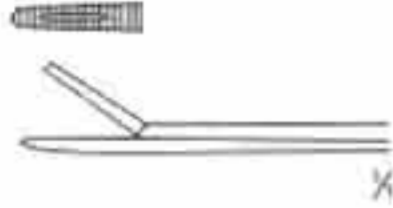

BUCK
LG12-182-001



QUIRE
LG12-183-120
12 cm, 4 3/4"



REINER
LG12-184-001
Tip Only



REINER
LG12-185-002
Tip Only



LG12-186-003
Shield



LG12-187-000 50CC Complete
LG12-188-000 100CC Complete
75CC Complete 150CC Complete
With Tip & Shield



EAR SYRINGES, ALLIGATOR EAR FORCEPS

Ohrspritzen, alligator-ohrfaßzangen

Seringues à oreilles, Pinces crocodiles à oreilles

Siringhe per orecchi, Pinze alligatore per orecchi

Jeringas para el oído, Pinzas de boca de cocodrilo para el oído



HARTMANN-WULLSTEIN
LG12-189-085



HARTMANN-WULLSTEIN
LG12-190-085



HARTMANN
LG12-191-085
LG12-192-140



HARTMANN
LG12-193-085
LG12-194-140



HARTMANN-NOYES
LG12-195-085



DUCKBILL
LG12-196-085



WEINGÄRTNER
LG12-197-085



HARTMANN
LG12-198-085 = 2.0 mm
LG12-199-140 = 2.5 mm
LG12-200-165 = 3.0 mm



HARTMANN
LG12-201-085 = 2.0 mm
LG12-202-140 = 2.5 mm
LG12-203-165 = 3.0 mm



STRÜMPEL
LG12-204-085



HARTMAN
LG12-205-085



HARTMANN
LG12-206-085



HARTMANN-HOFFMANN
LG12-207-085





MICRO EAR FORCEPS

Mikro-Ohrzangchen
Micro Pinzas Auriculares

Micro Pinces Auriculaires
Micro Pinze Auricolari

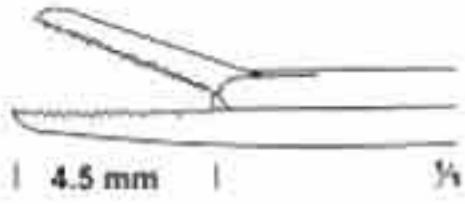

LG12-208-080
8 cm, 3"
Straight-Serrated
4.5 x 0.8 mm

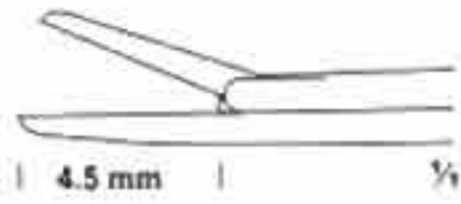

LG12-209-080
8 cm, 3"
Straight-Smooth
4.5 x 0.8 mm

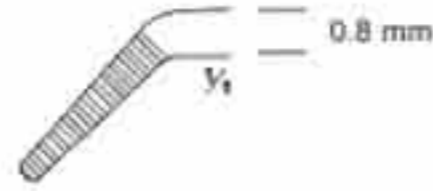

LG12-210-080
left

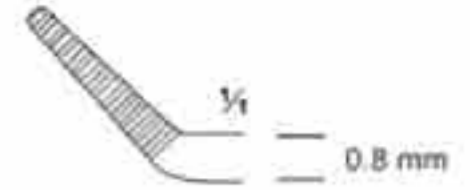

LG12-211-080
right

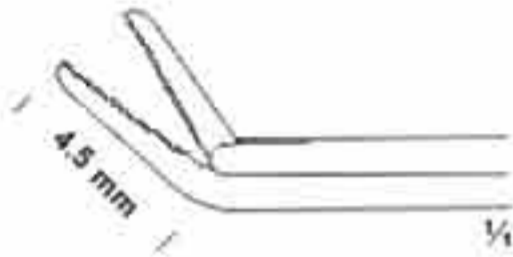

LG12-212-080
curved up

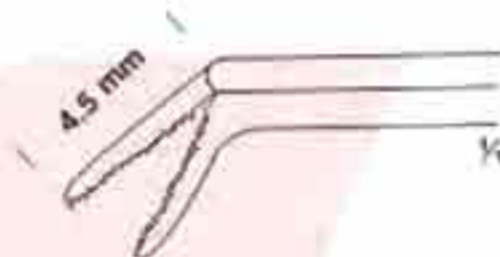

LG12-213-080
curved down

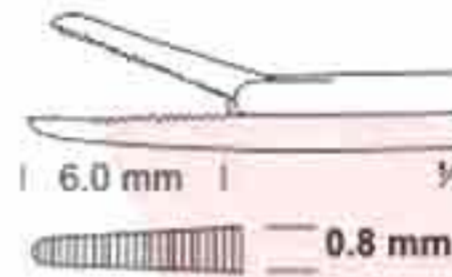

LG12-214-080
8 cm, 3"
Straight-Serrated
6 x 0.8 mm

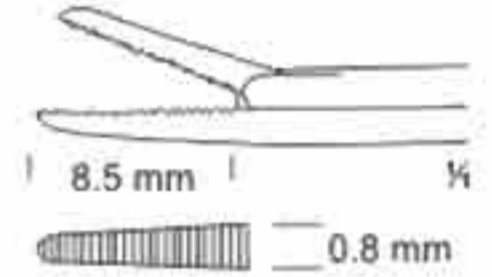

LG12-215-080
8 cm, 3"
Straight-Serrated
8.5 x 0.8 mm

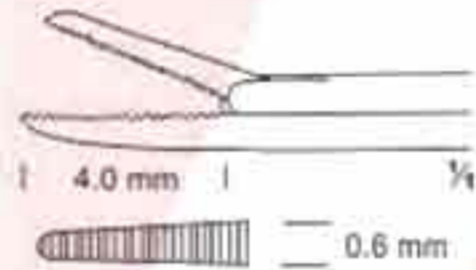

LG12-216-080
8 cm, 3"
Straight-Serrated
4 x 0.6 mm

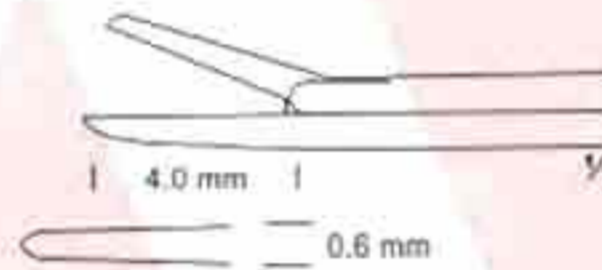

LG12-217-080



LG12-218-001
7.5 cm, 3"
With Stylus
1.0 mm



LG12-219-002
7.5 cm, 3"
With Stylus
1.5 mm



LG12-220-003
7.5 cm, 3"
With Stylus
2.0 mm



MICRO-EAR FORCEPS



MICRO EAR FORCEPS, MASTOID RONGEURS

Mikro-Ohrzangchen, Ohr-Knochenstanzen

Micro Pinzas Auriculares, Pinzas Cortantes Para Huesos

Micro Pincers Auriculaires, Ostéotomes Emporte-pièces

Micro Pinze Auricolari, Pinze Osteotomi



WULLSTEIN

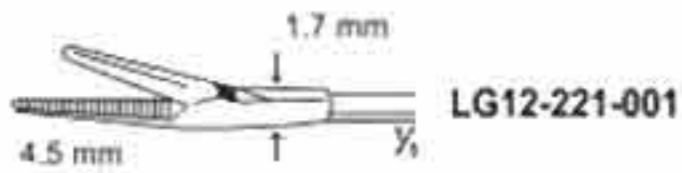

LG12-221-001

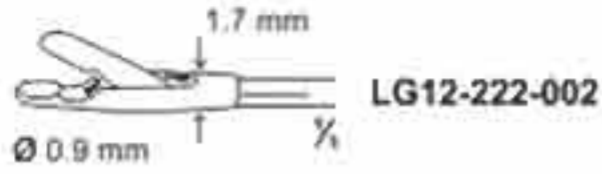

LG12-222-002

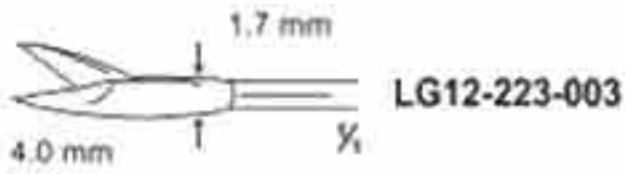

LG12-223-003



LG12-224-060
left

LG12-225-060
right

HOUSE-DIETER



LG12-226-060
left

LG12-227-060
right

HOUSE-DIETER



∩ 1 mm

∩ 2 mm

∩ 3 mm

CITELLI
LG12-228-060 6 cm, 2 1/2"
LG12-229-060 6 cm, 2 1/2"
LG12-230-060 6 cm, 2 1/2"



BEYER
LG12-231-090
9 cm, 3 1/2"



MICRO EAR FORCEPS

Mikro-Ohrzängchen
Micro Pinzas Auriculares

Micro Pincers Auriculaires
Micro Pinze Auricolari



LG12-232-080
8 cm, 3 1/4"
Straight

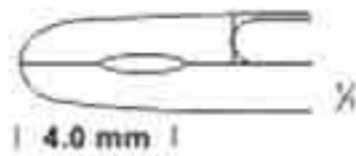

4.0 mm



LG12-233-080
8 cm, 3 1/4"
Curved right



LG12-235-080
8 cm, 3 1/4"
Curved left



LG12-234-080
8 cm, 3 1/4"
Curved up



LG12-236-080
8 cm, 3 1/4"
Curved down

LG12-237-001
Micro scissor
straight, sharp / sharp



BELLUCCI LG12-238-002
Micro scissor
curved up, blunt / blunt



BELLUCCI LG12-240-004
Micro scissor
curved to the right,
sharp / sharp



BELLUCCI LG12-239-003
Micro scissor
curved to the left,
sharp / sharp



BELLUCCI LG12-241-005
Micro scissor
horizontal cutting

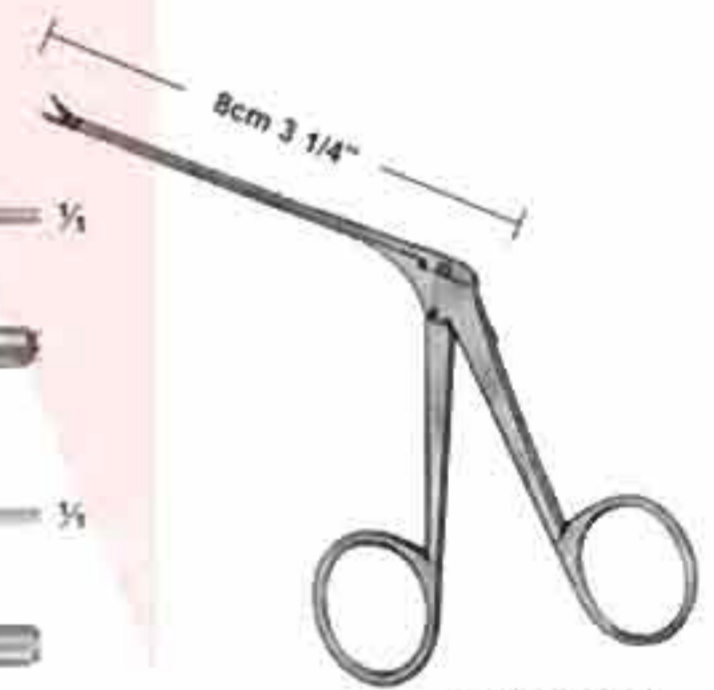

BELLUCCI
8 cm, 3 1/4"



CRURA-NIPPER
LG12-242-080
8 cm, 3 1/4"

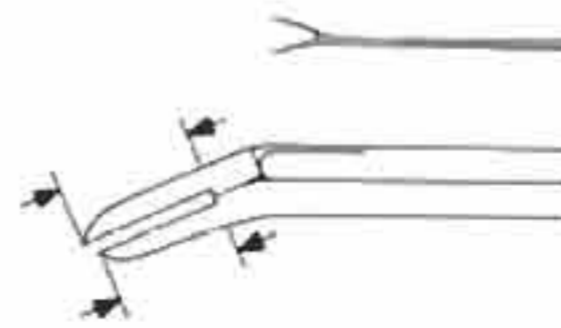

LG12-244-080
8 cm, 3 1/4"
0.8 x 3.5 mm



LG12-245-080
8 cm, 3 1/4"
0.8 x 6.0 mm



McGEE
LG12-243-080
8 cm, 3 1/4"



EAR FORCEPS

Ohrpoinzetten
Pinzas Auriculares

Pinces Auriculaires
Pinze Auricolari



TROELTSCH
LG12-244-110
11 cm, 4 1/2"



TROELTSCH
LG12-245-130
13 cm, 5"



TROELTSCH
LG12-246-120
12 cm, 5 1/4"



LUCAE
LG12-247-140
14 cm, 5 1/2"



JANSEN
LG12-248-160
16 cm, 6 1/4"



NASAL SPECULUM

Nasenspekula
Especulos Nasaes

Spéculums Nasaux
Specoli Nasali



KILLIAN
13 cm, 5 1/4"



MODIFIED WIEN

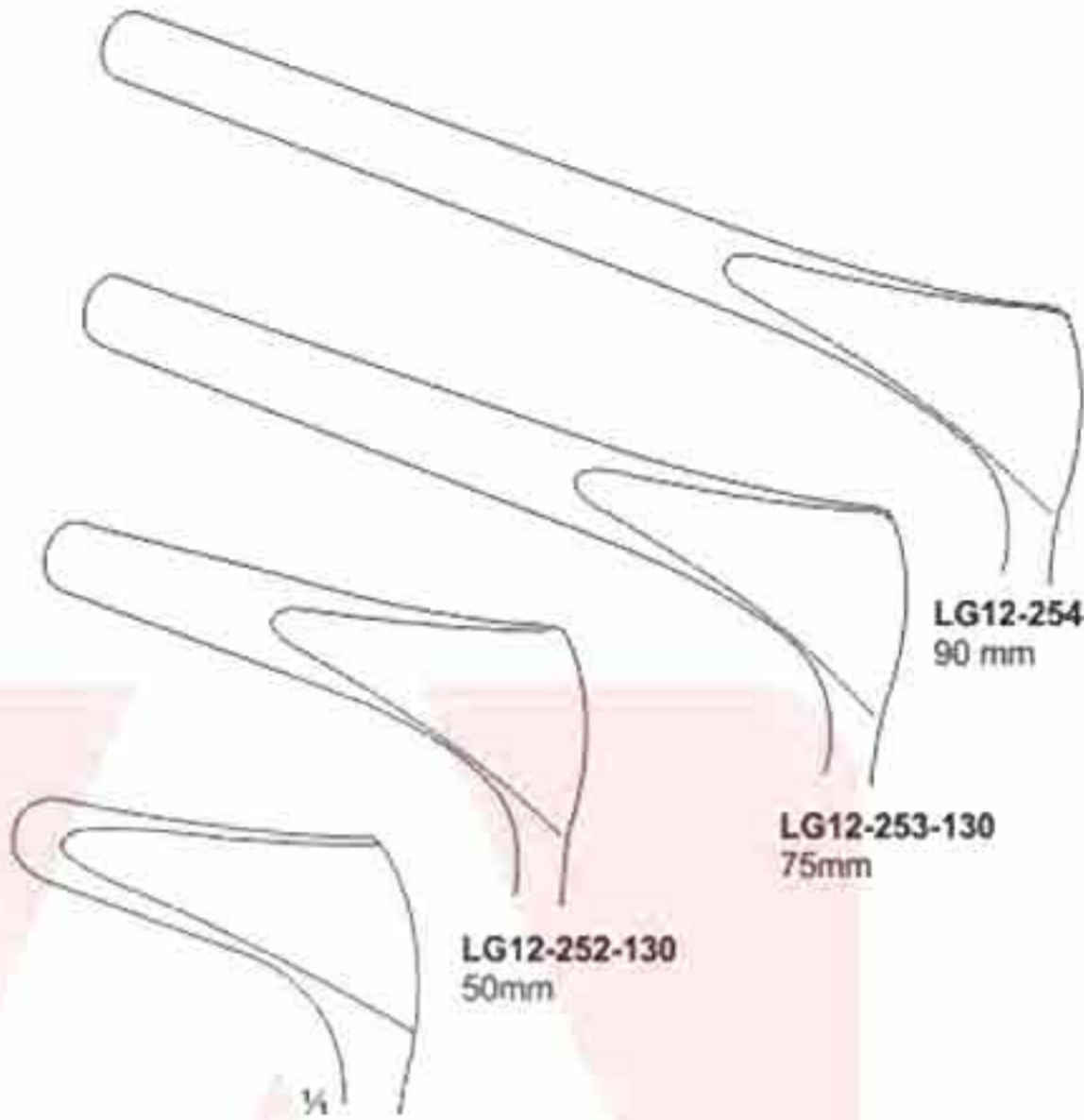

LG12-254-130
90 mm

LG12-253-130
75mm

LG12-252-130
50mm



LG12-251-130
35 mm

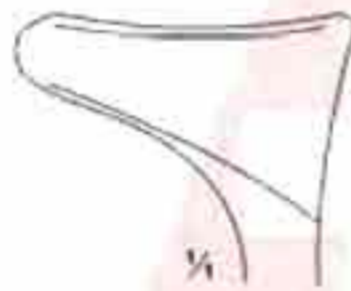

LG12-255-130
13.0 cm, 5 1/4"
2.5 cm Tip



LG12-256-130
13.25 cm, 5 1/4"
3 cm Tip

With Fixing Screw



COTTLE
LG12-257-150
15 cm, 6"



NASAL SPECULUM

Nasenspekula
Especulos Nasaes

Spéculums Nasaux
Specoli Nasali



COTTLE
15 cm, 6"

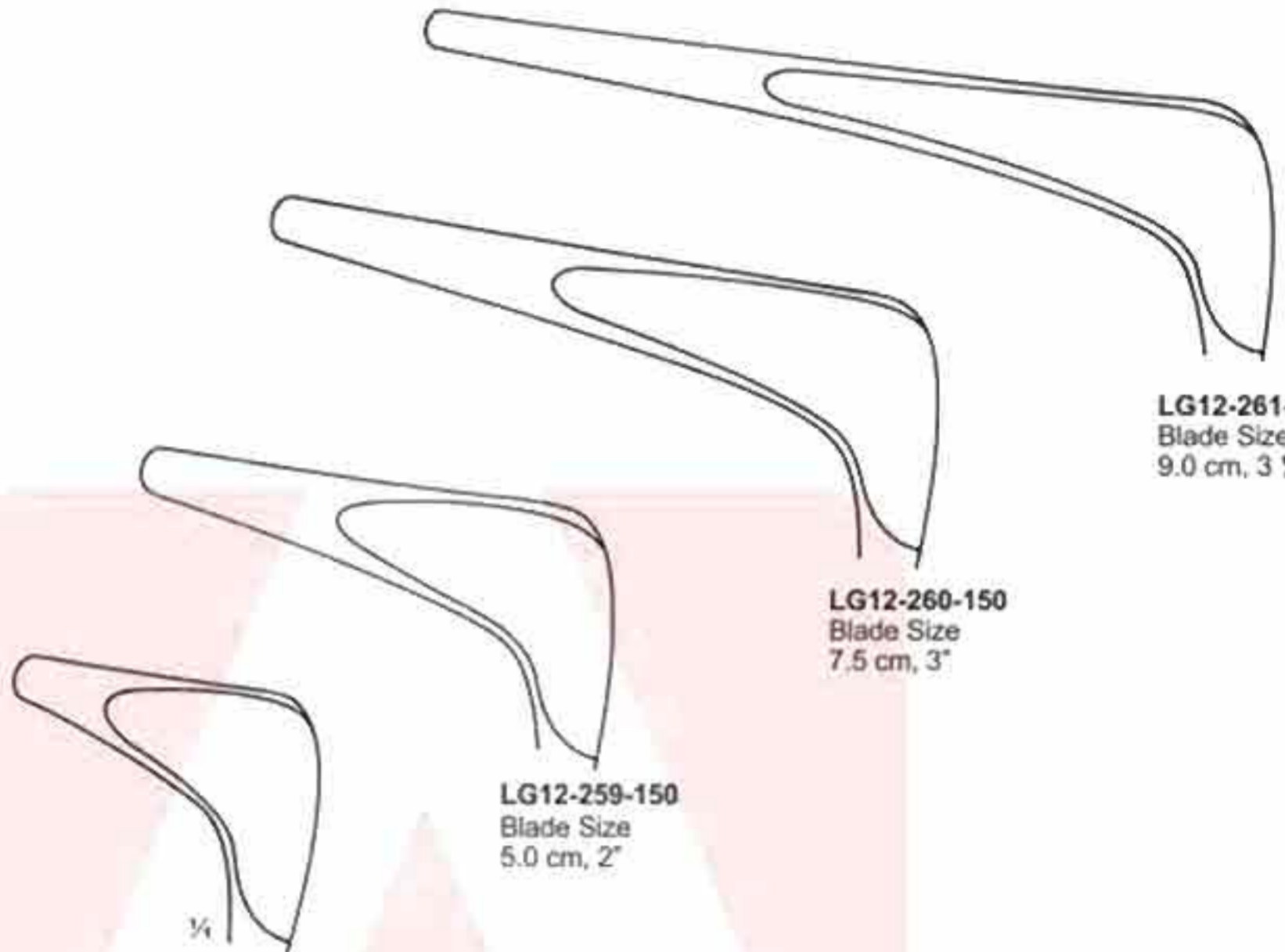

LG12-258-150
Blade Size
3.5 cm, 1 1/2"

LG12-259-150
Blade Size
5.0 cm, 2"

LG12-260-150
Blade Size
7.5 cm, 3"

LG12-261-150
Blade Size
9.0 cm, 3 1/2"

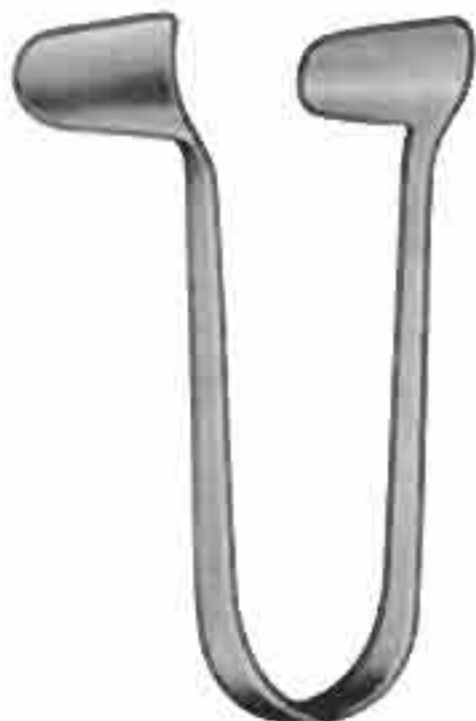

THUDICHUM
(Golfsmith)



LG12-266-065
6.5 cm, 2 1/2"



LG12-267-065
6.5 cm, 2 1/2"



LG12-268-065
6.5 cm, 2 1/2"



VOLTOLINI
(Duplay)



LG12-269-001



LG12-270-002



LG12-271-003



NASAL SPECULUM

Nasenspekula
Especulos Nasaes

Spéculums Nasaux
Specoli Nasali



TIECK-HALLE



LG12-272-135
13.5 cm, 5 1/2"



BECKMANN
LG12-273-130
13 cm, 5"



1/4



BECKMANN
15 cm, 6"



LG12-274-150



LG12-275-150

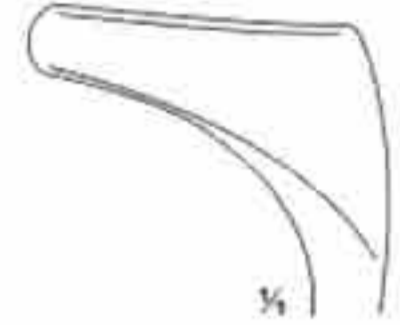

1/4
LG12-276-150



HARTMANN-HALLE
15 cm, 6"

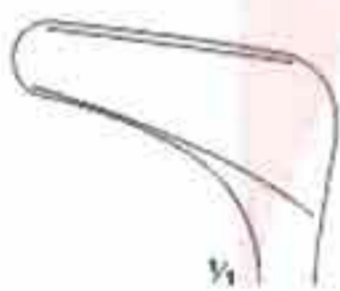

1/4
LG12-277-150

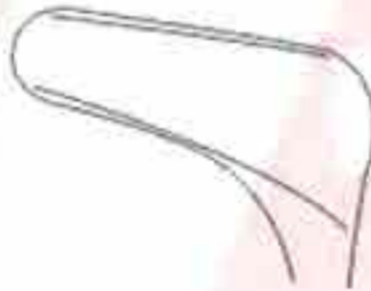

1/4
LG12-278-150



1/4
LG12-279-150



HARTMANN
15 cm, 6"

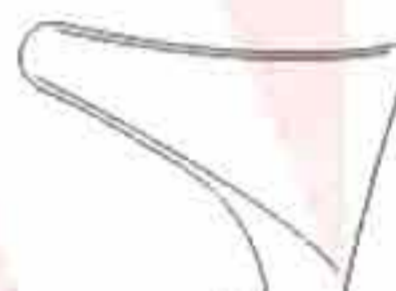

1/4
LG12-280-150



1/4
LG12-281-150

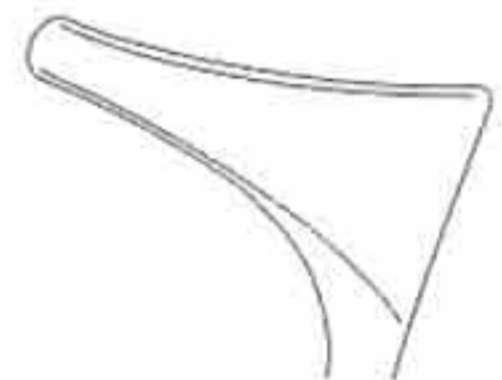

1/4
LG12-282-150



NASAL SPECULUM

Nasenspekula
Especulos Nasaes

Spéculums Nasaux
Specoli Nasali



MODIFIED WIEN
14.5 cm, 5 3/4"

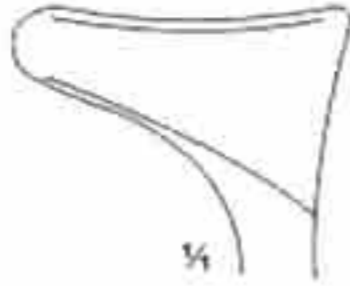

LG12-283-145
2.5 cm Tip



LG12-284-145
3 cm Tip



VIENNA NASAL SPECULUM
LG12-285-140 - Infant
LG12-286-140 - Child
LG12-288-140 - Adult
14 cm, 5 1/2"

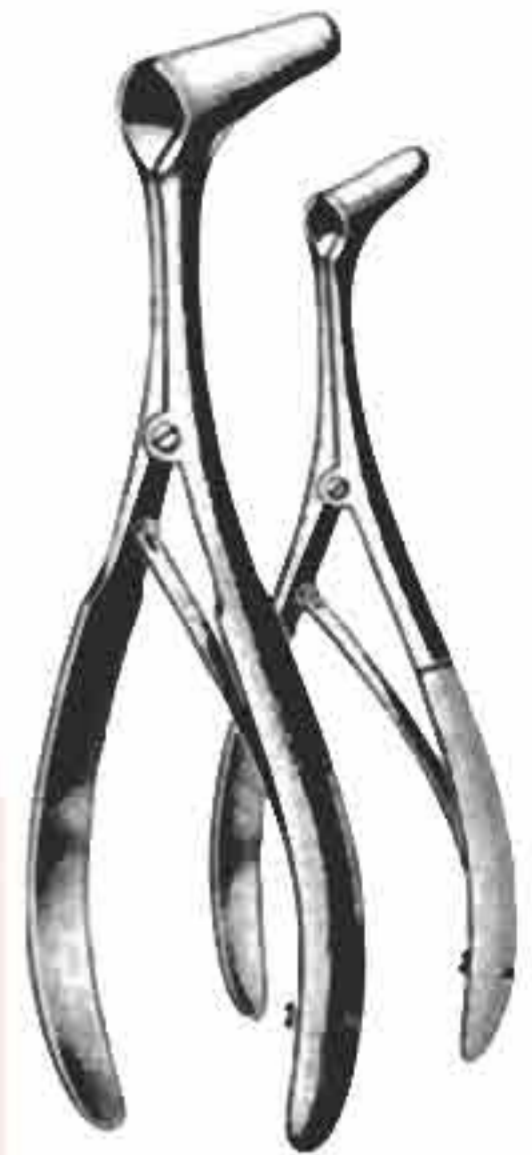

HALLE NASAL SPECULUM
LG12-289-140 - Infant
LG12-290-140 - Adult
14 cm, 5 1/2"



VIENNA NASAL SPECULUM
LG12-291-140 - Adult
14 cm, 5 1/2"



COTTLE SEPTAL SPECULUM
LG12-292-150 15 cm, 6" Blade 2.8 cm
LG12-293-150 15 cm, 6" Blade 5 cm
LG12-294-150 15 cm, 6" Blade 7.5 cm
LG12-295-150 15 cm, 6" Blade 10 cm



KILLIAN NASAL SPECULUM
LG12-296-130 5 cm, 2" Small blade
LG12-297-130 7.5 cm, 3" Medium blade
13 cm, 5 1/4"



SEPTUM FORCEPS

Nasenpolyenzangen
Pinzas Para Pólipos Nasaes

Pinces À Polypes Nasaux
Pinze Per Polipi Nasali



HARTMANN
LG12-298-160
16 cm, 6 1/4"
LG12-299-200
20 cm, 8"



HEYMANN-KNIGHT
LG12-300-180
18 cm, 7"

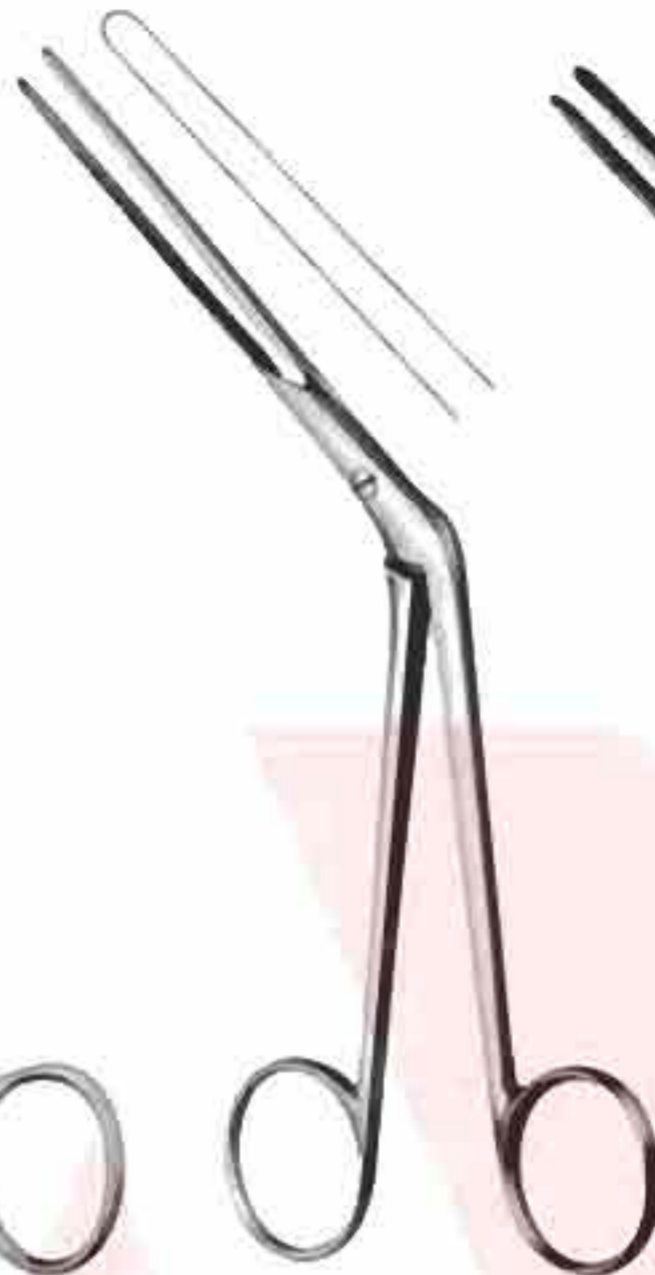

LUBET-BARBON
LG12-301-200
20 cm, 8"



KILLIAN
LG12-302-170
17 cm, 6 1/2"



WESTMACOTT



1/4"
LG12-303-200
20 cm, 8"



1/4"
LG12-304-200
20 cm, 8"

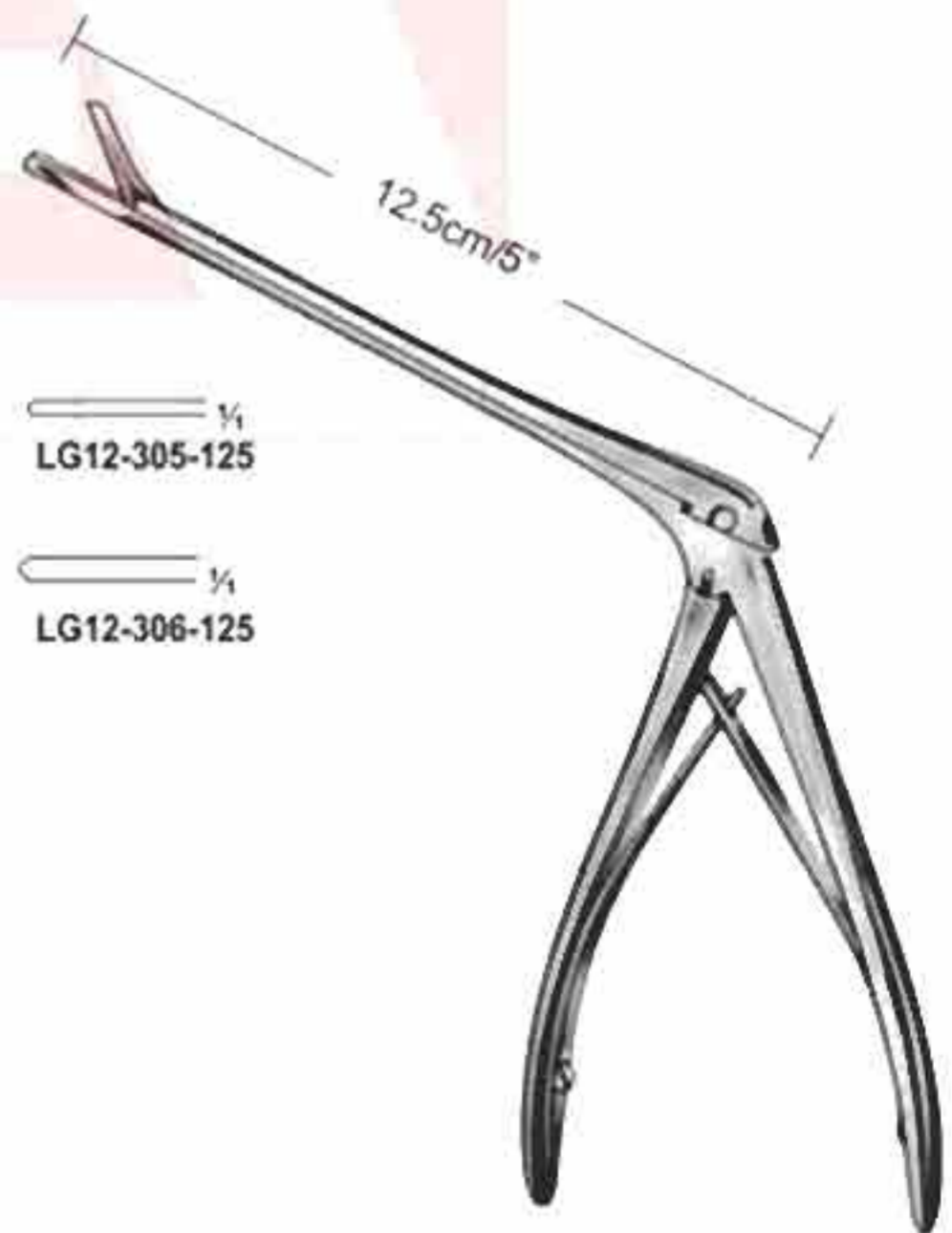

STRUYCKEN

1/4"
LG12-305-125

1/4"
LG12-306-125

12.5cm/5"



SEPTUM FORCEPS

Nasenpolypenzangen
Pinzas Para Pólipos Nasaes

Pinces À Polypes Nasaux
Pinze Per Polipi Nasali

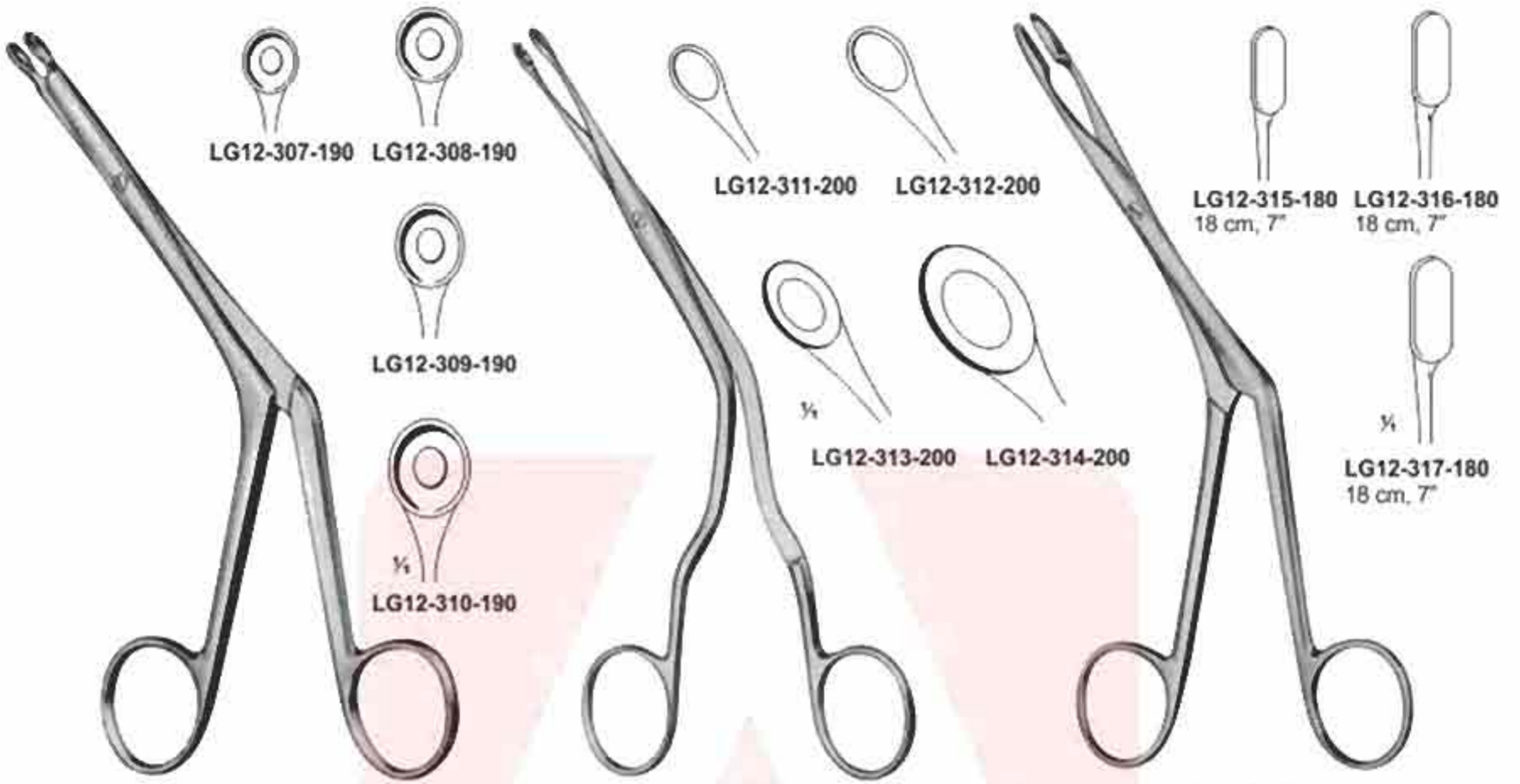

BRUENINGS
19 cm, 7 1/2"

LUC
20 cm, 8"

HEYMANN

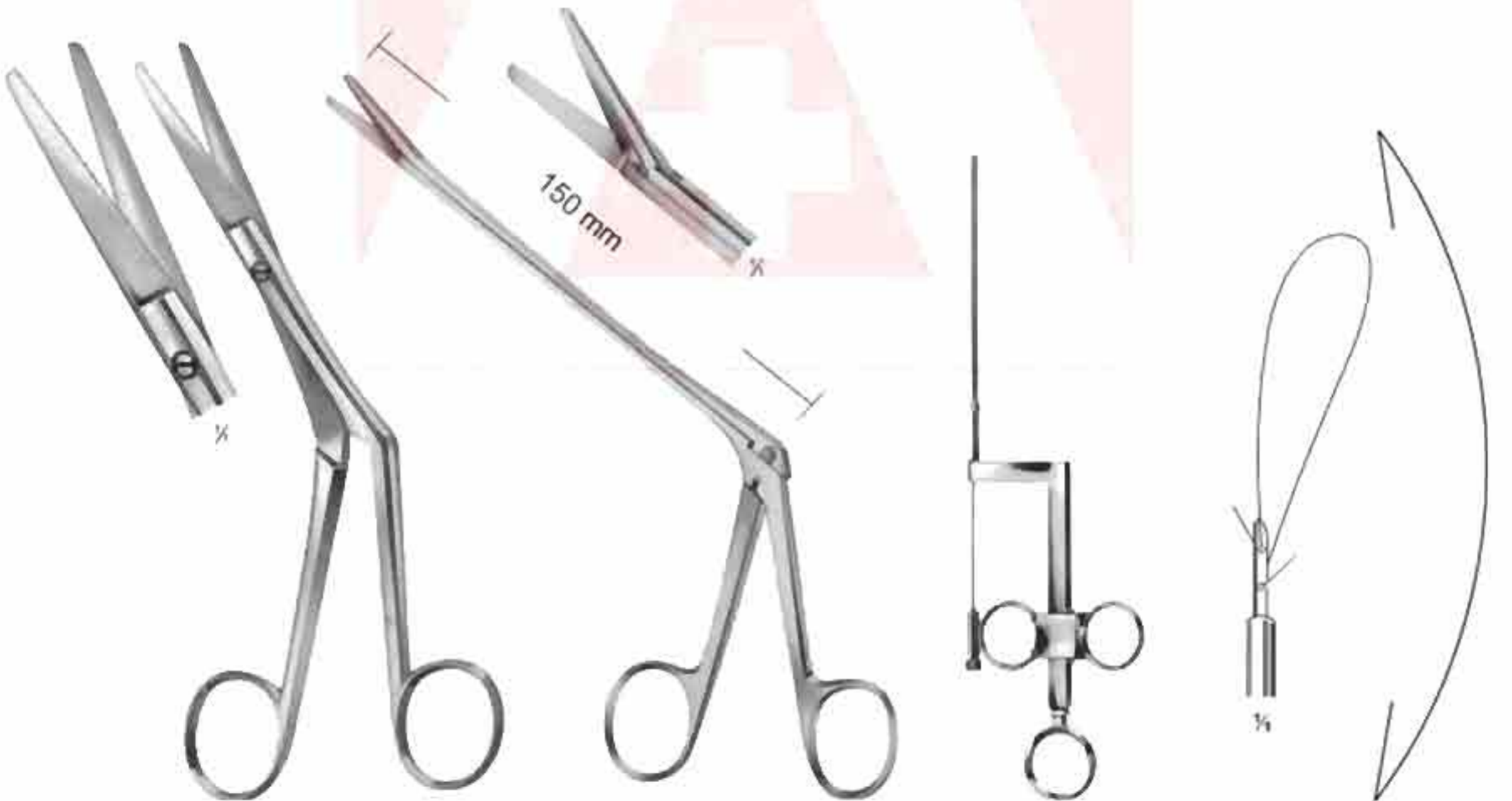

KIRSTEIN
LG12-318-180
Nasal Scissors,
blades serrated
18 cm, 7"

OLIVECRONE
LG12-319-225
Nasal Scissors,
22.5 cm, 9"

WILDE
LG12-320-250
Nasal Polypus Snare,
bayonet-shaped

LG12-321-001
Ø 0,3 mm
Wire Loops for nasal snares,
package of 100 pieces.
Sales unit: PH= 100 pieces



GLABELLA RASPS, NASAL RASPS

Glabellaraspein Nasenraspein

Escofinas Para Glabela, Escofinas Nasaes, Escofinas Nasaes

Râpes Pour La Glabelle, Râpes Nasaes, Râpes Nasaes

Raspe Per Glabella, Raspe Nasali, Raspe Nasali

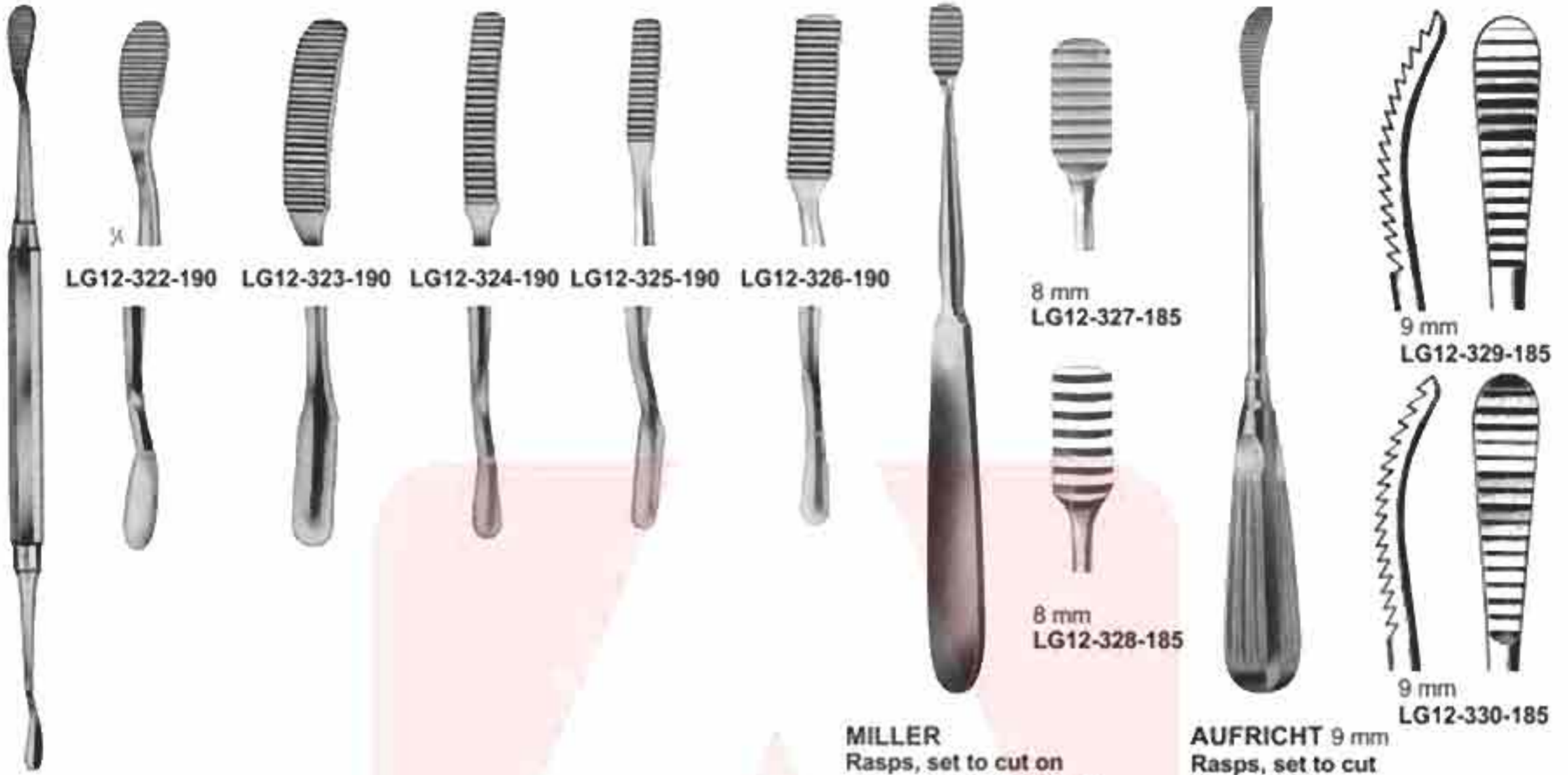

LG12-322-190 LG12-323-190 LG12-324-190 LG12-325-190 LG12-326-190

8 mm
LG12-327-185

9 mm
LG12-329-185

8 mm
LG12-328-185

9 mm
LG12-330-185

MILLER-COLBURN
19 cm, 7 1/2"

MILLER
Rasps, set to cut on down stroke, fine teeth
8 mm
Rasps, set to cut on down stroke, coarse teeth
18.5 cm, 7 1/4"

AUFRICHT 9 mm
Rasps, set to cut on up stroke
9 mm
Rasps, set to cut on down stroke
18.5 cm, 7 1/4"



LG12-331-180
Large Serrations

LEWIS
18 cm, 7"

MALTZ
LG12-332-180
straight
Rasp
18 cm, 7"

MALTZ
LG12-333-180
Rasp, teeth set to cut on down stroke
18 cm, 7"



GLABELLA RASPS, NASAL RASPS

Glabellaraspein Nasenraspein Escofinas Para Glabela, Râpes Pour La Glabelle, Râpes Nasaes, Râpes Nasaes
Escofinas Nasaes, Escofinas Nasaes Raspe Per Glabella, Raspe Nasali, Raspe Nasali

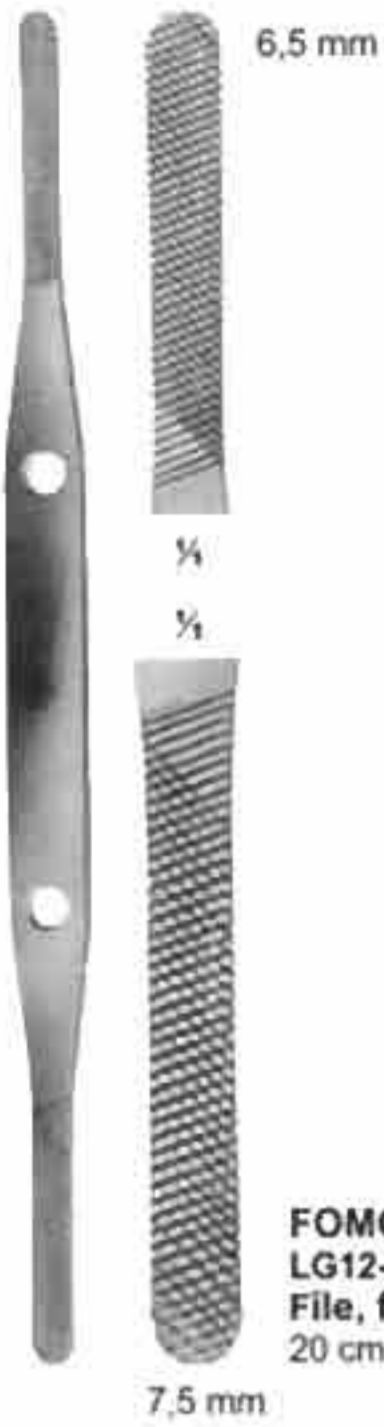

FOMON
LG12-334-200
File, fine / coarse
20 cm, 8"



FOMON
Rasp, fine /
coarse teeth
LG12-335-200
20 cm, 8"

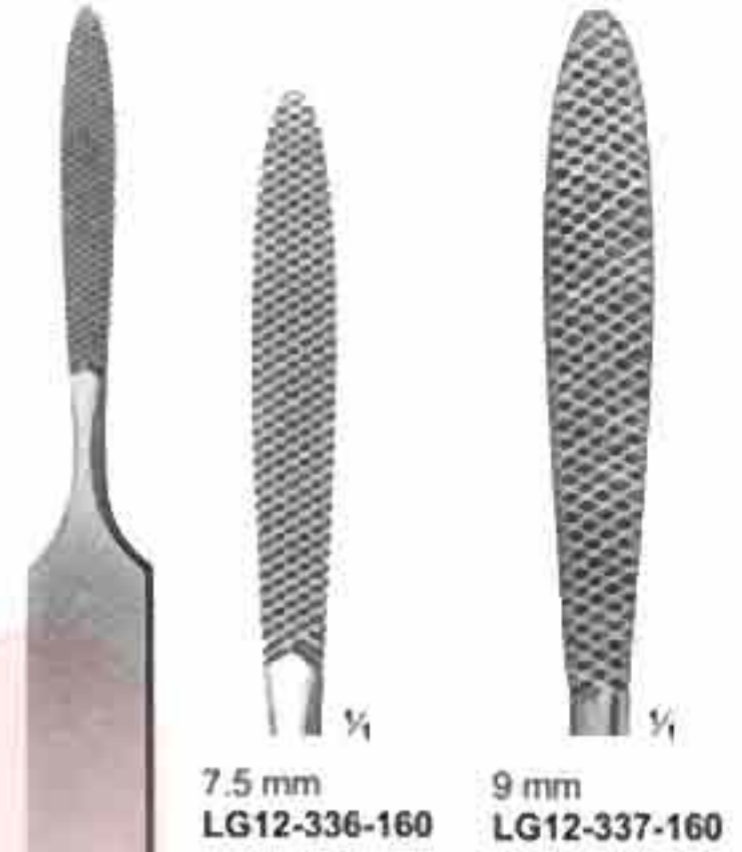

7.5 mm
LG12-336-160

9 mm
LG12-337-160

JOSEPH
fine chequered
coarse chequered
Rasp, for filling nasal bones
16 cm, 6 1/4"



With tungsten
carbide inserts

**RASPS, double
ended, with
tungsten
carbide inserts**
LG12-338-200
20 cm, 8"



LG12-339-001



LG12-340-002



LG12-341-003

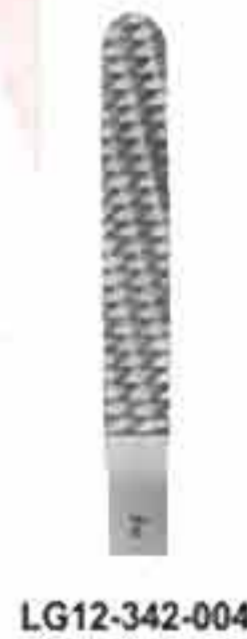

LG12-342-004

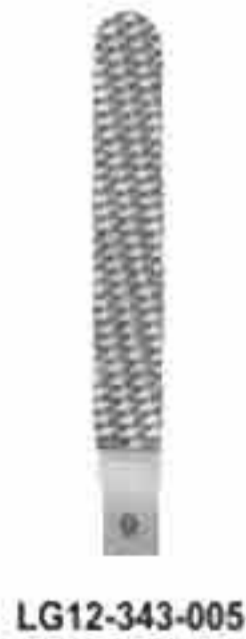

LG12-343-005



2



3



4



5



6



SPHENOID BONE PUNCHES

Pinzas Sacabocadas Para Esfenoides,
Pinzas Sacabocadas Para Seno Maxilar

Pinze Taglienti Per Seno Sfenoidale,
Pinze Taglienti Per Seno Mascellare

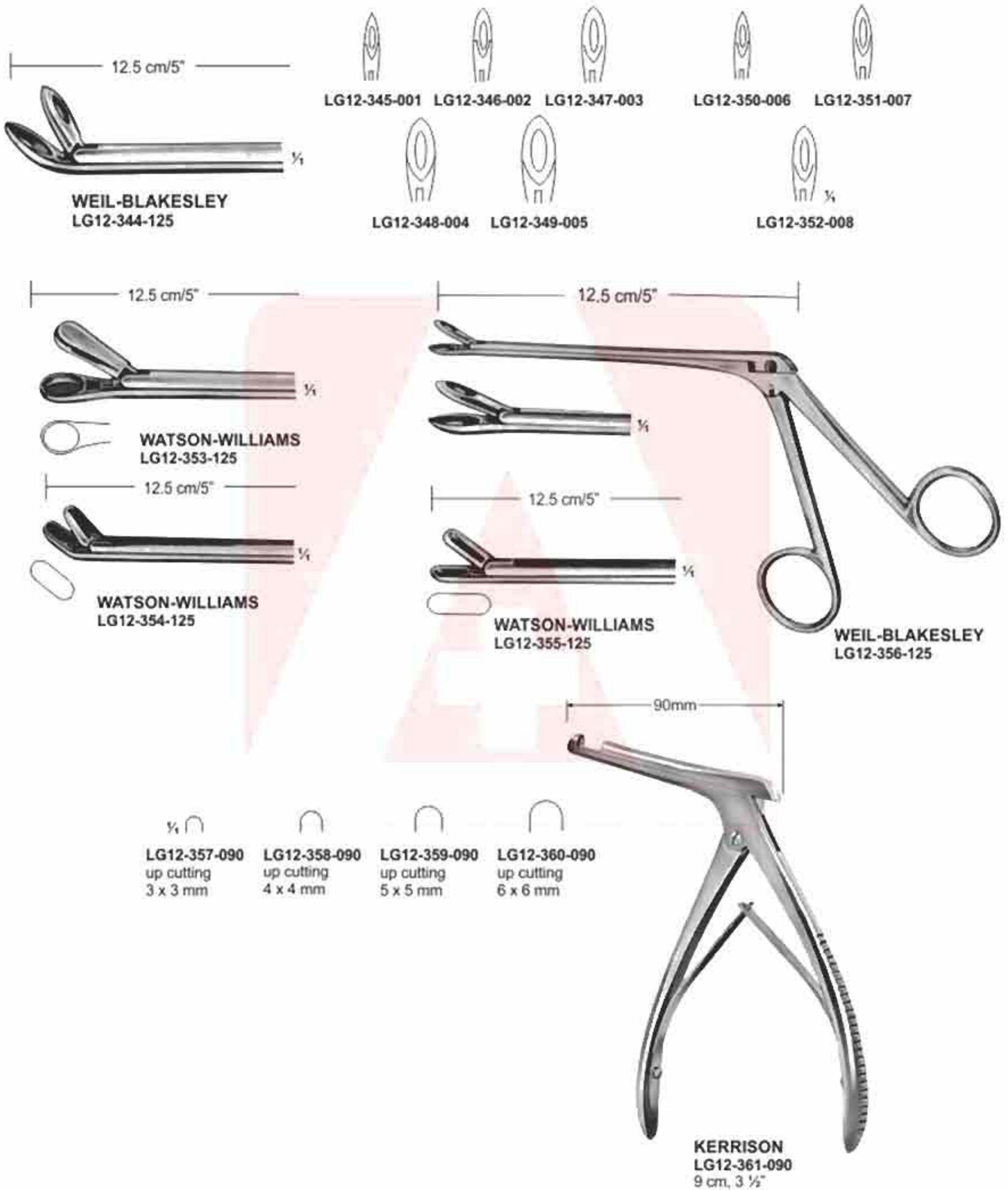



TONSIL PUNCHES

Tonsillenzangen
Pinzas Para Amígdalas

Pinces Pour Amygdalas
Pinze Per Tonsille

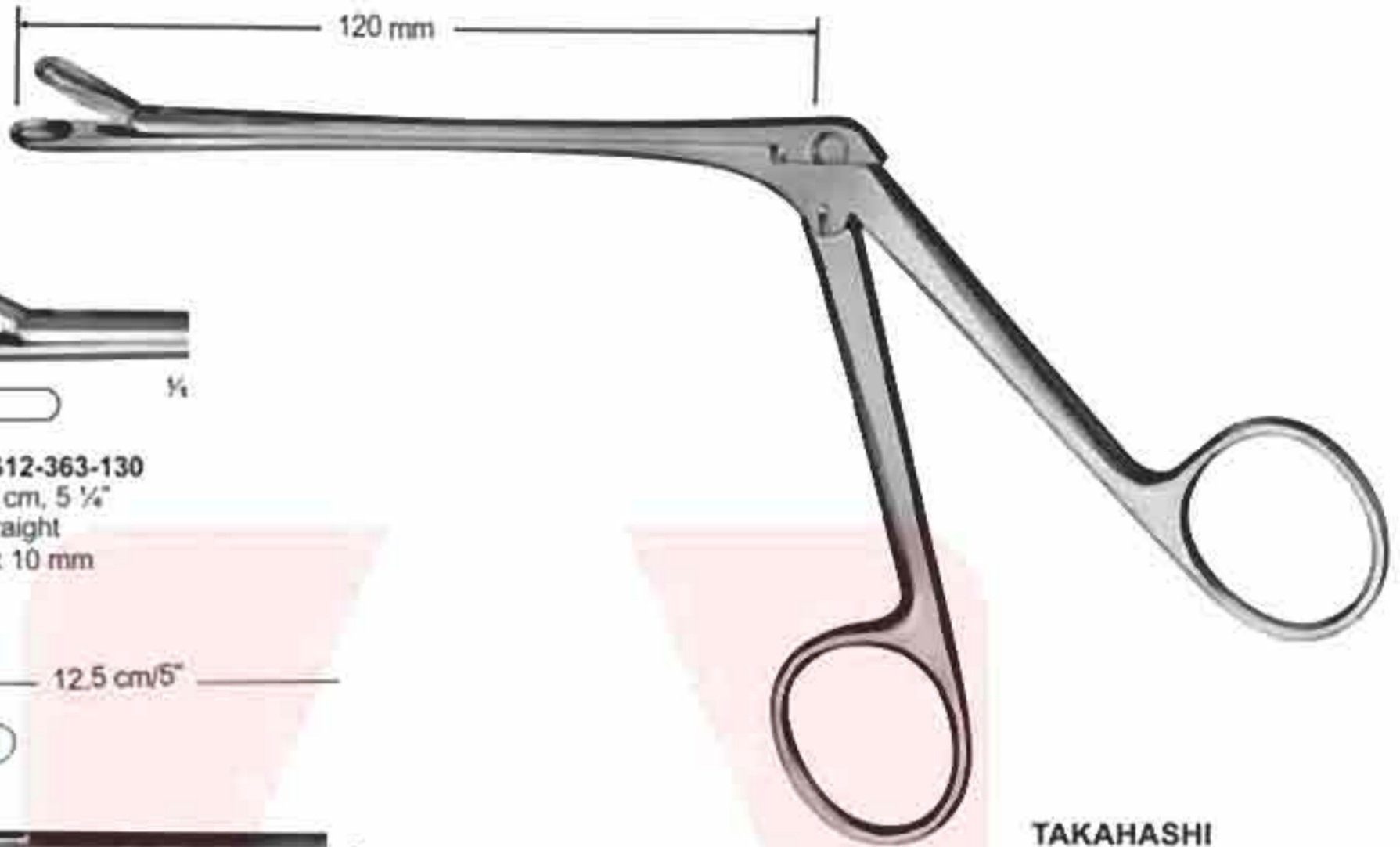

TAKAHASHI
19 cm, 7 1/2"



LG12-363-130
13 cm, 5 1/4"
Straight
5 x 10 mm

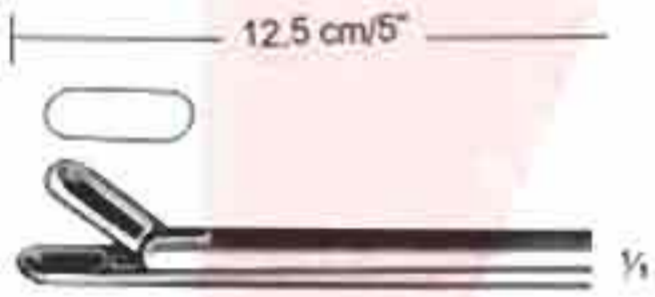

WATSON-WILLIAMS
LG12-364-125

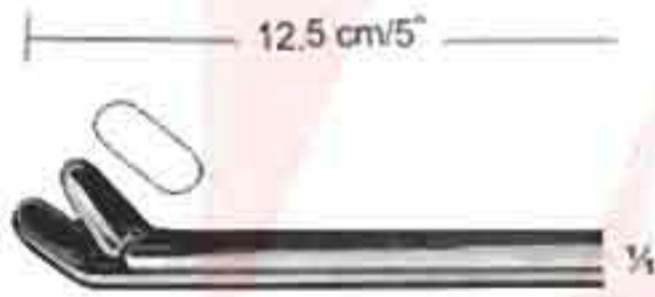

WATSON-WILLIAMS
LG12-365-125

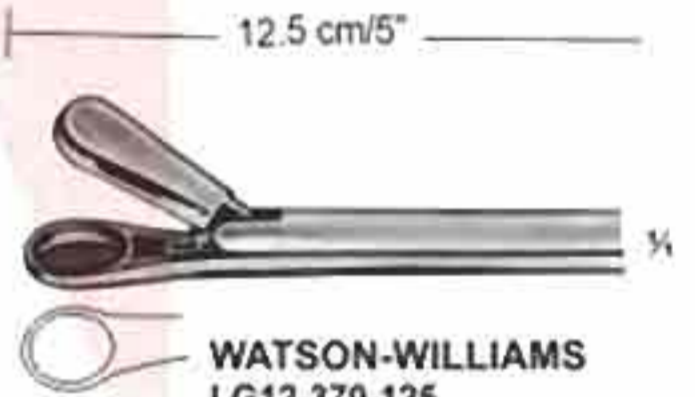

WATSON-WILLIAMS
LG12-370-125



LG12-371-125



LG12-372-125

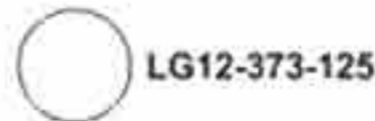

LG12-373-125



LG12-374-125

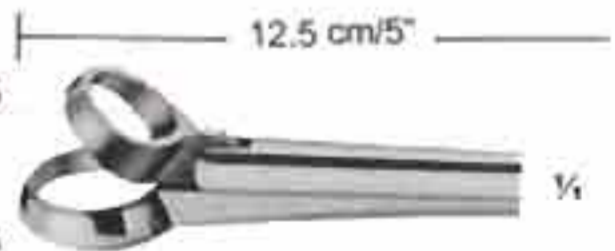

HARTMANN
Nasal Cutting Forceps



LG12-366-125



LG12-367-125



GRUENWALD-HENKE
Nasal Cutting Forceps
Nasal Cutting forceps



LG12-368-125



LG12-369-125

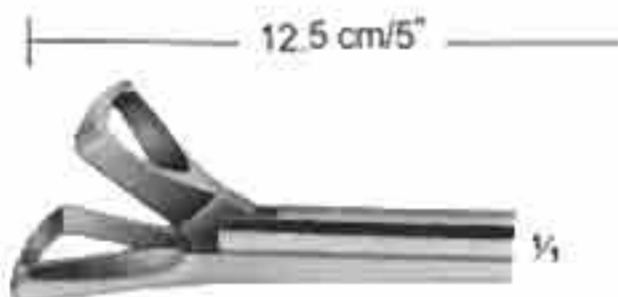

SCHMEDEN
Nasal Cutting Forceps

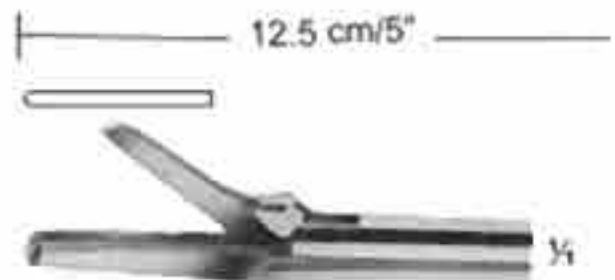

STRUYCKEN
Nasal Cutting Forceps
LG12-375-125



SUCTION TUBE

Sauger, Saugrohre
Tubos de aspiración

Tubos d aspiracion
Tubi d aspirazion



FERGUSSON

LG12-376-180 Ø 2.0 mm, 6 F.G.
LG12-377-180 Ø 2.5 mm, 7-8 F.G.
LG12-378-180 Ø 3.0 mm, 9 F.G.
LG12-379-180 Ø 4.0 mm, 12 F.G.
LG12-380-180 Ø 5.0 mm, 15 F.G.
18 cm, 7"



PLESTER

LG12-381-195 Ø 1.5 mm, 4-5 F.G.
LG12-382-195 Ø 2.0 mm, 6 F.G.
LG12-383-195 Ø 2.5 mm, 7-8 F.G.
LG12-384-195 Ø 3.0 mm, 9 F.G.
19.5 cm, 8"



NASAL SUCTION TUBES

LG12-385-160 Ø 5 mm
16 cm, 6 1/4"



FRAZIER

LG12-386-180 Ø 3 mm
LG12-387-180 Ø 5 mm
18 cm, 7"



FRAZIER



LG12-388-175
Outside 4,5 diam.
17.5 cm, 7"



LG12-389-175
Outside 5,5 diam.
17.5 cm, 7"



DERMAL PUNCH

Hauttrephine
Trépano para piel

Trépan cutané
Trefina cutanea



2mm Ø
LG12-390-001

3mm Ø
LG12-391-002

4mm Ø
LG12-392-003

5mm Ø
LG12-393-004

6mm Ø
LG12-394-005

7mm Ø
LG12-395-006

KEYES
LG12-390-001 — LG12-395-006
Dermal Punches



TONGUE DEPRESSOR
LG12-396-145
14.5 cm, 5 1/4"



TONGUE DEPRESSOR
LG12-397-145
14.5 cm, 5 1/4"



BUCHWALD
LG12-398-180
Tongue Depressor
18 cm, 7"



BRUENINGS
LG12-399-190
Tongue Depressor
19 cm, 7 1/2"



MOUTH GAG, LIP & CHEEK RETRACTORS

Mundsperrer, Lippen- u. Wangenhalter
Abrebocas, Separadores Para Labios y Mejillas

Ouvre-bouche, Ecarteurs Des Lèvres et Joues
Apribocca, Separatori Per Labbra e Guancia



ROSER-KONIG
LG12-400-160
16 cm, 6 1/4"
Mouth Gag



DENHARDT
LG12-401-125
12.5 cm, 5"
Mouth Gag
with silicon inserts,
interchangeable



FERGUSON-ACKLAND
LG12-402-145
14.5 cm, 5 3/4"



DOYEN-COLLIN
LG12-403-120 12 cm, 5"
LG12-404-140 14 cm, 5 1/2"
Mout Gag



MOLT
LG12-405-110
11 cm, 4 1/2"



MOUTH GAG, LIP & CHEEK RETRACTORS

Mundsperrer, Lippen- u. Wangenhalter
Abrebocas, Separadores Para Labios y Mejillas

Ouvre-bouche, Ecarteurs Des Lèvres et Joues
Apribocca, Separatori Per Labbra e Guancia



HEISTER
LG12-406-130 13 cm, 5"
Mouth Gag

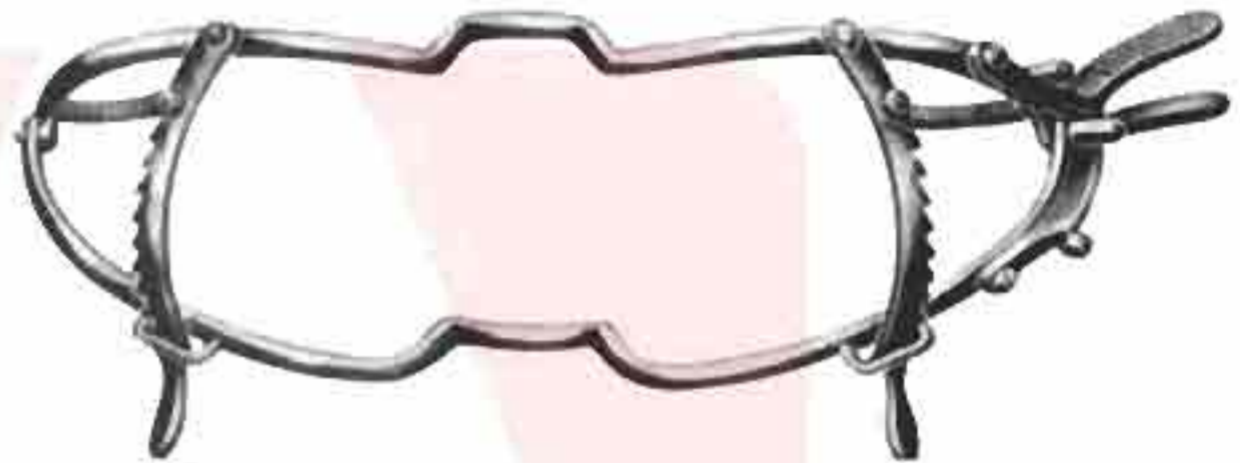

WHITEHEAD
LG12-407-090 9 cm, 3 1/2"
LG12-408-110 11 cm, 4 1/4"
LG12-409-130 13 cm, 5"
LG12-410-150 15 cm, 6"
Mouth Gag



WHITEHEAD
LG12-411-110 11 cm, 4 1/4"
LG12-412-130 13 cm, 5"
LG12-413-150 15 cm, 6"
Mouth Gag
with tongue depressor



WHITEHEAD-JENNINGS
LG12-414-090 9 cm, 3 1/2"
LG12-415-110 11 cm, 4 1/4"
LG12-416-130 13 cm, 5"
LG12-417-150 15 cm, 6"
Mouth Gag



MOUTH GAGE

Mundsperrer
Abrebocas

Ouvre-bouche
Apribocca

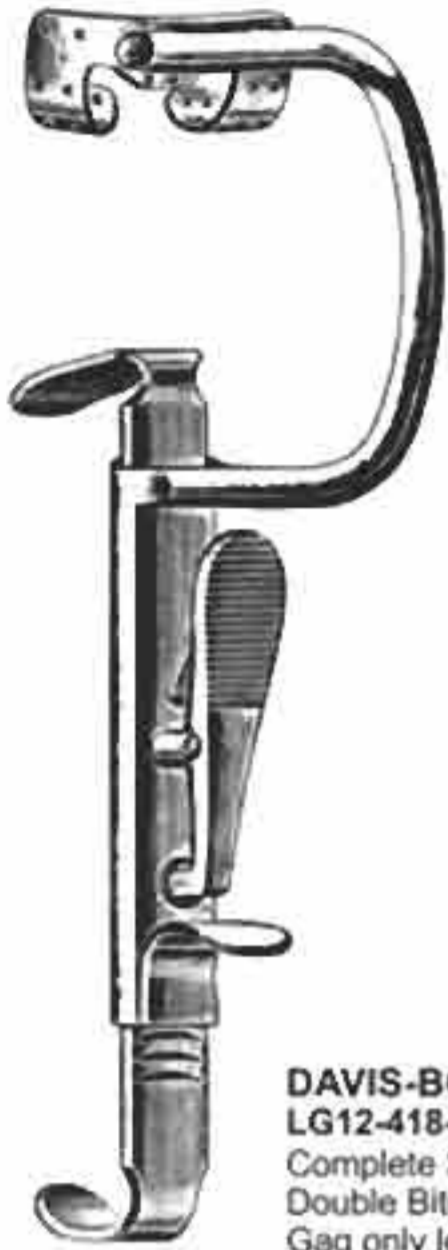

DAVIS-BOYLE
LG12-418-001
Complete Set
Double Bite-Lift Side
Gag only left side



12-550-001



LG12-420-002



LG12-421-003



LG12-422-004



LG12-423-005

DAVIS-BOYLE
LG12-419-001 20 X 25mm
LG12-420-002 22 X 60mm
LG12-421-003 25 X 75mm
LG12-422-004 25 X 90mm
LG12-423-005 27 X 105mm
Tongue Blades only.



LG12-424-001
Gag Only

MCIVOR



27 x 95 mm



22 x 85 mm



22 x 70 mm

LG12-425-001
Complete Set
with 3 Blades

MCIVOR
blade



MODELL WURZBURG
LG12-426-001 66 x 28 mm
LG12-427-002 75 x 32 mm
LG12-428-003 83 x 34 mm
LG12-429-004 93 x 37 mm
LG12-430-005 100 x 38 mm



TONSIL GRASPING FORCEPS, TONSIL FORCEPS

Tonsillenfasszangen, Tonsillenklemmen
Pinzas Para Amigdalas

Pinces Pour Amygdalas
Pinze Per Tonsille

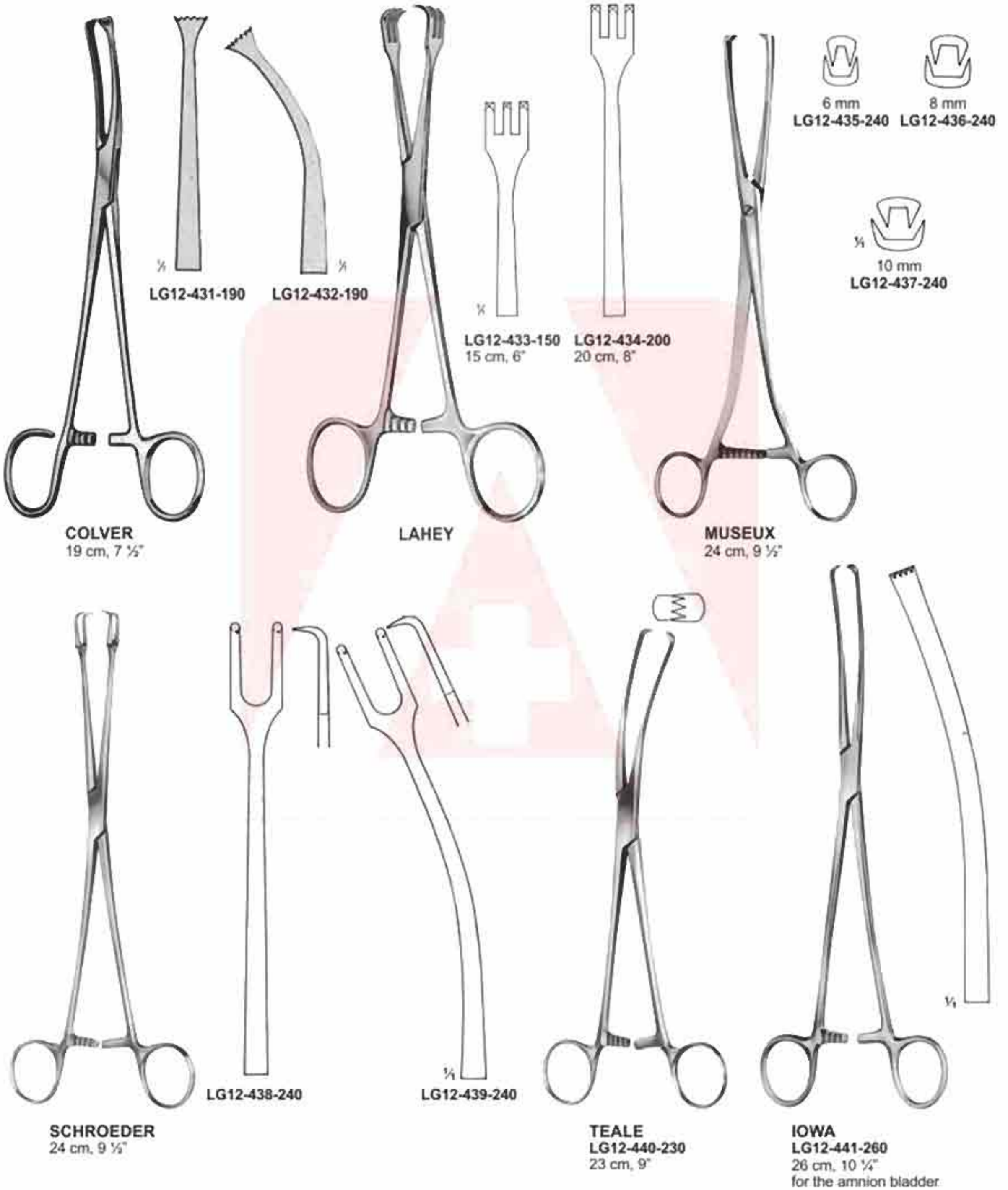



TONSIL FORCEPS

Tonsillenklemmen
Pinzas Para Amigdalas

Pinces Pour Amygdalas
Pinze Per Tonsille



STAUDE-MOORE
LG12-442-170
17 cm, 6 3/4"
strong pattern



POZZI
LG12-443-255
25.5 cm, 10 1/4"



SCHROEDER
LG12-444-250
25 cm, 10"



BRAUN
LG12-445-250
25 cm, 10"



DUPLAY
LG12-446-280
28 cm, 11"



BEACHAM
LG12-447-260
26 cm, 10 1/4"



SKENE
LG12-448-240
24 cm, 9 1/2"



TONSIL SNARES, ALAR HOOKLETS

Tonsillenschnürer, Nasenflügelhäkchen

Cierra-nudos Para Amígdalas, Ganchitos Para Alas De Nariz

Serre-noeuds Pour Amygdalas, Crochets Pour Les Ailes Du Nez

Serranodi Per Tonsille, Uncini Per Le Pinne Nasali

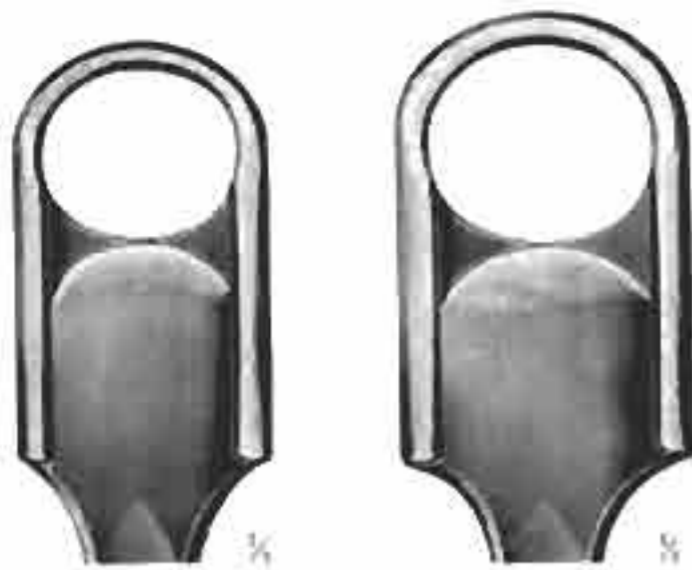

LG12-449-001

LG12-450-002



LG12-451-003

Complete, with 3 tips fig. 1-3



SLUDER-BALLENGER

LG12-452-004

complete, with 3 tips fig. 1-3

Blades For Tonsillotome Handle



GAYNNE EVANS

Tonsil dissector,

double ended

LG12-453-200

20 cm 8"



LUER
LG12-454-110
11 cm, 4 1/4"



JACKSON
LG12-455-150
15 cm, 6"



Left

BOSE
LG12-456-160
16 cm, 6 1/4"



Right

BOSE
LG12-457-160
16 cm, 6 1/4"



ITERSON
16 cm, 6 1/4"



LG12-458-160
Sharp



LG12-459-160
Blunt



SCHOENBORN
LG12-460-210
21 cm, 8 1/4"



LUKENS
LG12-461-170
17 cm, 6 1/2"



LARYNGEAL MIRRORS, LARYNGEAL MIRROR HANDLES

Kehlkopfspiegel, Kehlkopfspiegel-griffe

Miroirs Laryngiens, Manche Pour Miroirs Laryngiens

Espejos Laringeos, Mangos Para Espejos Laringeos

Specchi Laringel, Manico Per Specchi Laringei



LARYNGEAL MIRROR
with Handle



LG12-462-001
fig 00 = 8mm



LG12-463-002
fig 0 = 10mm



LG12-464-003
fig 1 = 12mm



LG12-465-004
fig 2 = 14mm



LG12-466-005
fig 3 = 16mm



LG12-467-006
fig 4 = 18mm



LG12-468-007
fig 5 = 20mm



LG12-469-008
fig 6 = 22mm



LG12-470-009
fig 7 = 24mm



LG12-471-010
fig 8 = 26mm



Mirror
LG12-472-150
15 cm, 6"



Handle for
All Sizes
LG12-473-150
15 cm, 6"



LG12-474-001
1 - Electric mirror handle with light
2 - With three spare battery



TRACHEAL TUBES

Trachealkanülen
Cánulas Traqueales

Canules Tracheales
Cannule Tracheali



LUER



CHEVALIER-JACKSON

Fig.	mm ø	N		
		46-90 mm	95 mm	46-90 mm
0	4 mm	LG12-475-004		
1	5 mm	LG12-476-005		
2	6 mm	LG12-477-006		
3	7 mm	LG12-478-007		
4	8 mm	LG12-479-008	LG12-485-008	LG12-491-008
5	9 mm	LG12-480-009	LG12-486-009	LG12-492-009
6	10 mm	LG12-481-010	LG12-487-010	LG12-493-010
7	11 mm	LG12-482-011	LG12-488-011	LG12-494-011
8	12 mm	LG12-483-012	LG12-489-012	LG12-495-012
9	13 mm	LG12-484-013	LG12-490-013	LG12-496-013

Fig.	mm ø	N
		46-90 mm
0	4 mm	LG12-497-004
1	5 mm	LG12-498-005
2	6 mm	LG12-499-006
3	7 mm	LG12-500-007
4	8 mm	LG12-501-008
5	9 mm	LG12-502-009
6	10 mm	LG12-503-010
7	11 mm	LG12-504-011
8	12 mm	LG12-505-012
9	13 mm	LG12-506-013



SPEAKING TUBE
outer tube closed
inner tube closed
LG12-507-001

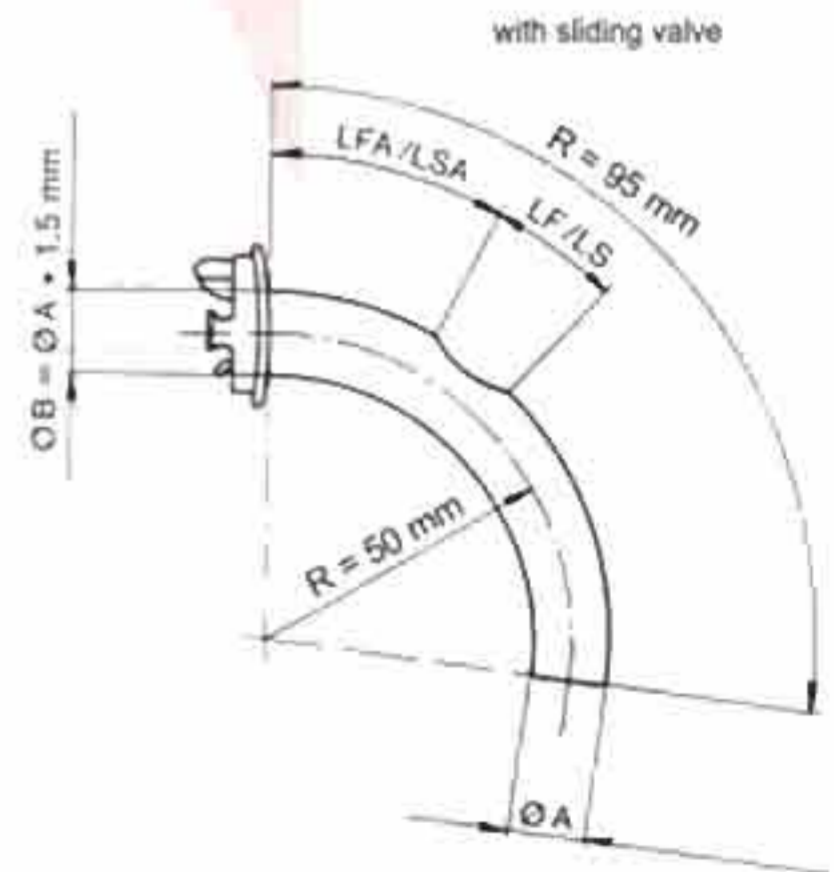
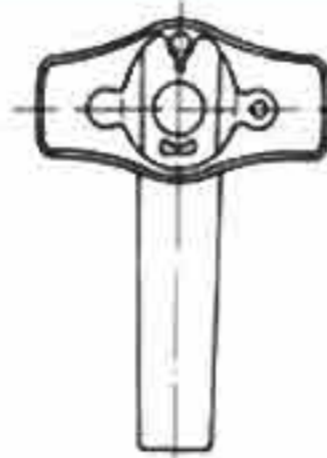

Fig.	Item	Ø A	L	Radius
A	LG12-508-008	08mm	95mm	50mm
A	LG12-509-009	09mm	95mm	50mm
A	LG12-510-010	10mm	95mm	50mm
A	LG12-511-011	11mm	95mm	50mm
A	LG12-512-012	12mm	95mm	50mm
A	LG12-513-013	13mm	95mm	50mm



TRACHEOTOMY SET

Tracheotomie
Traqueotomia

Tracheotomie
Tracheotomia

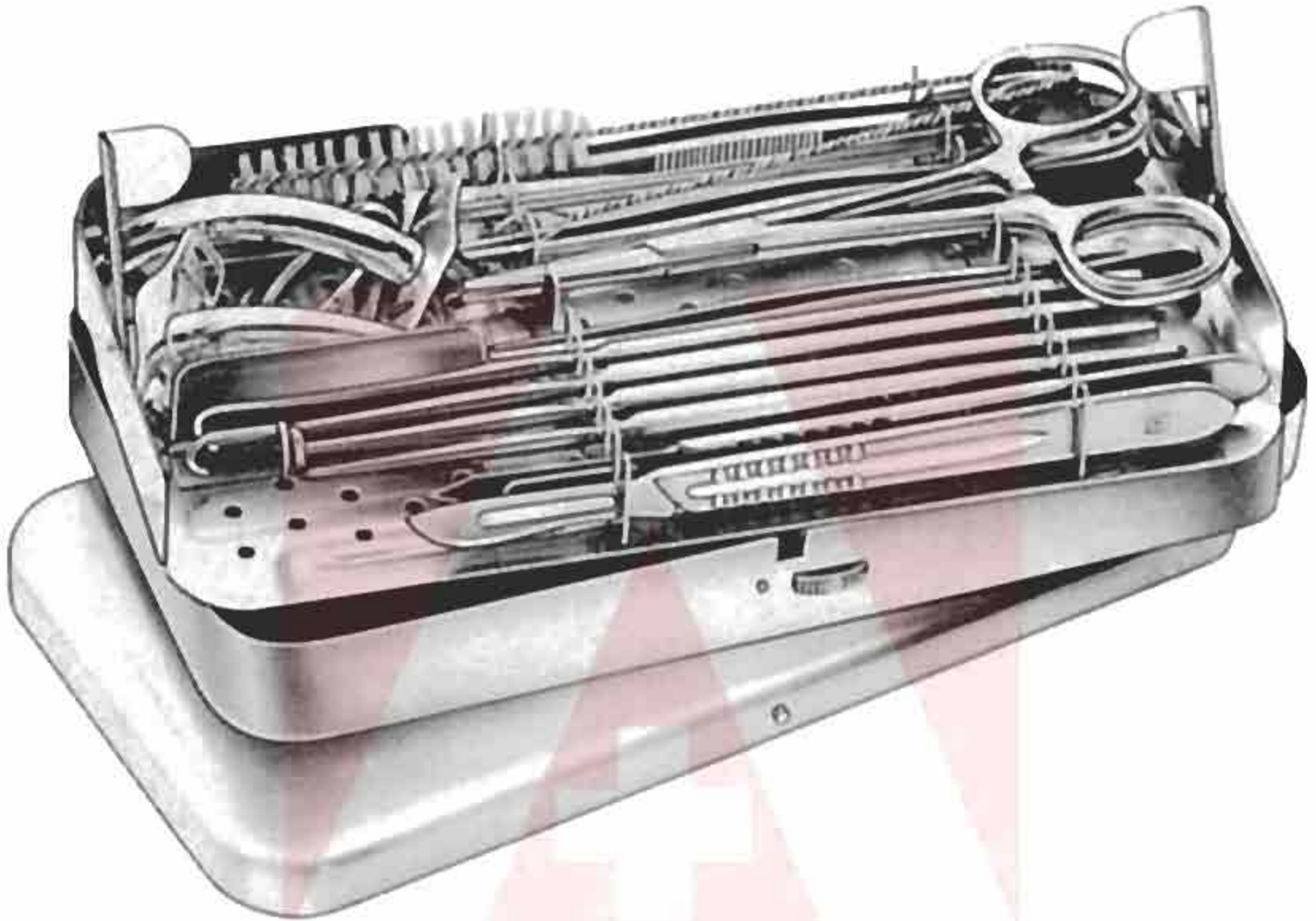

- | | |
|--------------|--|
| LG12-514-001 | 1 Metal Case |
| | In Metal Case Consisting Of: |
| LG12-515-002 | 1 Handle With 1 Blade Fig. 20 |
| LG12-516-003 | 1 Handle With 1 Blade Fig. 23 |
| LG12-517-004 | 1 Thumb Forceps 13cm |
| LG12-518-005 | 1 Tissue Forceps 13cm, 1 x 2 teeth |
| LG12-519-006 | 2 Pean Artery Forceps 13cm |
| LG12-520-007 | 1 Grooved Director 13cm |
| LG12-521-008 | 1 Trachea Dilator |
| LG12-522-009 | 2 Trachea Retractors, Iterson, Blunt |
| LG12-523-010 | 1 Trachea Retractor, Bose, Sharp, Left |
| LG12-524-011 | 1 Trachea Retractor, Bose, Sharp Right |
| LG12-525-012 | 1 Luer Trachea Tube Standard |
| LG12-526-013 | 1 Luer Trachea Tube Standard |
| LG12-527-014 | 1 Cleaning Brush |



BRONCHO-ESOPHAGOSCOPY FORCEPS

Broncho-Oesophagoskopiezangen
Pinzas Para Broncho-Esofagoscopia

Pinces Pour Broncho-Esofagoscopie
Pinze Per Broncho-Esofagoscopia



BRÜNINGS
LG12-528-001
Universal handle, with lever
on the left, for use with
tubes
LG12-532-200 to
LG12-537-500



AESCULAP
LG12-529-140
14 cm, 5 1/2"
Universal handle, with lever
on the right, for use with
tubes
LG12-532-200 to
LG12-537-500



HUBER
LG12-530-140
14 cm, 5 1/2"
Universal handle, with lever
on the right, for use with
tubes
LG12-532-200 to
LG12-537-500



BRÜNINGS
LG12-531-200
20 cm, 8"
Curved Tube with Stylet,



BRÜNINGS
LG12-532-200 20 cm, 8"
LG12-533-250 25 cm, 10"
LG12-534-300 30 cm, 12"
LG12-535-350 35 cm, 14"
LG12-536-400 40 cm, 16"
LG12-537-500 50 cm, 20"
Straight Tubes with
Stylet, stiff



EXCHANGEABLE TIPS

Auswechselbare Zangenaufsätze
Pinzas Intercambiables

Embouts Interchangeables
Pinze Intercambiabili

LG12-538-001



LG12-539-002



KAHLER
LG12-540-003



EICKEN
LG12-541-004



FRAENKEL
LG12-542-005



FRAENKEL
LG12-543-006



SCHEINMANN
LG12-544-007



BRÜNINGS

LG12-545-008 Ø 2 mm. Ø 2 mm. Ø 3 mm. Ø 4 mm.
LG12-546-009 Ø 3 mm.
LG12-547-010 Ø 4 mm.



BRÜNINGS
LG12-548-011



LANGE
LG12-549-012



LANGE
LG12-550-013



KRAUSE
LG12-551-014
LG12-552-015



SCHEINMANN
LG12-553-016



SCHEINMANN
LG12-554-017



CORDES
LG12-555-018



CORDES
LG12-556-019



ROSENBERG
LG12-557-020



STRUYCKEN
LG12-558-021

