



Allegro Surgical Corporation

Surgical Instruments Catalogue



INTRODUCTION

INTRODUCTION

In 1956 Mr. Feroz Baig started his business single handed and was a maker of surgical instruments in local market. He was very technical, skilled in hand made instruments, buyers just provide instrument and patterns and he developed the instruments by hand.

In 1967 His two elder sons Azeem & Aaleam baig join his father local business and contact with foreign buyers, they used new equipments and designs for instruments, they were very appreciated by foreign buyers and they started the export under the company "HEALTH & WEALTH"

In 1977 The 3rd younger brother M. Anwar Baig join the company and well trained by his father & big brothers, it is the time when they boost the business with efficiency & hard working of Mr. Anwar Baig and they produce a huge variety of instruments.

In 1981 Mr. Anwar Baig establish his company Allegro surgical corp. where from he got a great confidence and trust of medical professionals and company became a world known healthcare source in medical community.

2007-2011

Now Mr.Imran Baig is running the company and from his period of joining company growing very smoothly and also launched company branches in USA, ITALY, BELGIUM.

Now the Allegro is a GROUP of listed companies

Allegro Surgical Corp (Serving for Surgical, Dental & Holloware)

Allegro Tools (Serving for Jewelry, Optial, Watch & General Tools)

Allegro Inc (Serving for Beauty Care Instruments)

Mr.Baig also started a project for big factory unit for Allegro which is almost going to complete soon.

www.allegro.com.pk (Allegro Surgical Corp)
www.allegro-tools.com (Allegro Tools)
www.allegro-inc.us (Allegro inc (USA) (Beauty Care)



TABLE OF CONTENTS









| S. No. | | | Page No. |
|--------|---|---|----------|
| 02 | <i>Scalpel Holders, Amputation & Saws</i> |  | 21 |
| 03 | <i>Scissors</i> |  | 31 |
| 04 | <i>Haemostatic Forceps</i> |  | 52 |
| 05 | <i>Dressing & Tissue Forceps</i> |  | 79 |
| 06 | <i>Needle Holders</i> |  | 95 |
| 07 | <i>Retractors</i> |  | 101 |
| 08 | <i>General Instruments</i> |  | 149 |

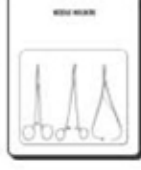
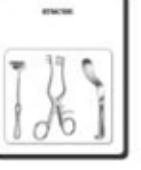

TABLE OF CONTENTS

| S. No. | | | Page No. |
|--------|--|---|----------|
| 13 | <i>Intestinal & Rectal Instruments</i> |  | 240 |
| 17 | <i>Index</i> |  | 299 |

S I N C E 1 9 8 1



SCALPEL HOLDERS, AMPUTATION & SAWS

- SCALPEL HOLDERS
- DISSECTING KNIVES
- AMPUTATION KNIVES
- SAWS





SCALPEL HANDLES

Skalpgriffe
Mangos de bisturíes

Manches pour bistouris
Manici per bisturi



SCALPEL HANDLE #4
LG2-001-120
12.75 cm, 5"
Blade Size
20, 22, 25



SCALPEL HANDLE #3
LG2-002-120
12.75 cm, 5"
Blade Size
10, 11, 12, 15



**SCALPEL HANDLE/
GRADUATED #3**
LG2-003-120
12.75 cm, 5"
Blade Size
10, 11, 12, 15



SCALPEL HANDLE #4L
LG2-004-210
21 cm, 8 1/4"



SCALPEL PLASTIC HANDLE
LG2-005-001
8



COLLIN
LG2-006-001
9



Fig. 10



Fig. 11

Blade Sizes



Fig. 12



Fig. 15



Fig. 20



Fig. 22



SCALPEL HANDLES

Skalpellgriffe
Mangos de bisturíes

Manches pour bistouris
Manici per bisturi



**#3, #4 SCALPEL
HANDLE**
LG2-007-160
16 cm, 6"



**#7 SCALPEL
HANDLE**
LG2-008-165
16.5 cm, 6 1/4"
Blade
10, 11, 12, 15



**SCALPEL
HANDLE
4L long**
LG2-009-210
21 cm, 8 1/4"



**SCALPEL
HANDLE
3L LONG**
LG2-010-210
21 cm, 8 1/4"
Blade Size
10, 11, 12, 15



**#3 SCALPEL HANDLE /
LONG ANGLED**
LG2-011-200
20.25 cm, 8 1/4"
Blade Size
10, 11, 12, 15



SCALPEL HANDLES

Skalpellgriffe
Mangos de bisturíes

Manches pour bistouris
Manici per bisturi



SCALPEL
HANDLE
LG2-012-115
11.5 cm, 4 1/2"



SCALPEL
HANDLE
LG2-013-160
16 cm, 6 1/4"



SCALPEL
HANDLE
LG2-014-127
12.7 cm, 5"



SCALPEL
HANDLE
LG2-015-110
11 cm, 4 1/4"



SCALPEL
HANDLE
LG2-016-127
12.7 cm, 5"



SCALPEL
HANDLE
LG2-017-135
13.5 cm, 5 1/4"



TROUTMAN-CHRIS
LG2-018-090
9 cm, 3 1/2"



TROUTMAN-CHRIS
LG2-019-090
9 cm, 3 1/2"



BLADE HOLDER
BLADE BREAKER
LG2-020-110
11 cm, 4 1/4"



CASTROVIEJO
LG2-021-130
13 cm, 5 1/4"



S I C E 1 9 8 1



DISSECTING KNIVES

Anatomische skalpelle
Bisturías para disección

Bistouris à dissection
Bisturi para dissezione



DIEFFENBACH
16 cm, 6 1/4"



Fig. 1
LG2-022-160
16 cm, 6 1/4"



Fig. 2
LG2-023-160
16 cm, 6 1/4"



Fig. 3
LG2-024-160
16 cm, 6 1/4"



Fig. 4
LG2-025-160
16 cm, 6 1/4"



Fig. 5
LG2-026-160
16 cm, 6 1/4"



Fig. 6
LG2-027-160
16 cm, 6 1/4"



Fig. 7
LG2-028-160
16 cm, 6 1/4"



Fig. 8
LG2-029-160
16 cm, 6 1/4"



Fig. 9
LG2-030-160
16 cm, 6 1/4"



Fig. 15
LG2-031-160
16 cm, 6 1/4"



Fig. 16
LG2-032-160
16 cm, 6 1/4"



DISSECTING KNIVES

Anatomische skalpelle
Bisturíes para disección

Bistouris à dissection
Bisturi para dissezione



COLLIN
14.5 cm, 5 3/4"



Fig. 1
LG2-033-145
14.5 cm, 5 3/4"



Fig. 2
LG2-034-145
14.5 cm, 5 3/4"



Fig. 3
LG2-035-145
14.5 cm, 5 3/4"



Fig. 4
LG2-036-145
14.5 cm, 5 3/4"



Fig. 5
LG2-037-145
14.5 cm, 5 3/4"



Fig. 6
LG2-038-145
14.5 cm, 5 3/4"



DIEFFENBACH
13.5 cm, 5 1/4"



Fig. 1
LG2-039-135
13.5 cm, 5 1/4"



Fig. 2
LG2-040-135
13.5 cm, 5 1/4"



Fig. 3
LG2-041-135
13.5 cm, 5 1/4"



Fig. 4
LG2-042-135
13.5 cm, 5 1/4"



Fig. 5
LG2-043-135
13.5 cm, 5 1/4"



Fig. 6
LG2-044-135
13.5 cm, 5 1/4"



Fig. 7
LG2-045-135
13.5 cm, 5 1/4"



Fig. 8
LG2-046-135
13.5 cm, 5 1/4"



Fig. 9
LG2-047-135
13.5 cm, 5 1/4"



Fig. 10
LG2-048-135
13.5 cm, 5 1/4"



DISSECTING KNIVES

Anatomische skalpelle
Bisturíes para disección

Bistouris à dissection
Bisturi para dissezione



02-056-170
17 cm, 6 3/4"



Fig. 1
LG2-049-170
17 cm, 6 3/4"



Fig. 3
LG2-050-170
17 cm, 6 3/4"



Fig. 5
LG2-051-170
17 cm, 6 3/4"



Fig. 7
LG2-052-170
17 cm, 6 3/4"



Fig. 9
LG2-053-170
17 cm, 6 3/4"



Fig. 10
LG2-054-170
17 cm, 6 3/4"



Fig. 12
LG2-055-170
17 cm, 6 3/4"



Fig. 14
LG2-056-170
17 cm, 6 3/4"



Fig. 16
LG2-057-170
17 cm, 6 3/4"



Fig. 18
LG2-058-170
17 cm, 6 3/4"



DISSECTING KNIVES

Anatomische skalpelle
Bisturíes para disección

Bistouris à dissection
Bisturi para dissezione



DISSECTING KNIFE
15 cm, 6"
with metal handle



LG2-059-150
15 cm, 6"



30 mm



LG2-060-150
15 cm, 6"



36 mm



LG2-061-155
15.5 cm, 6"



40 mm



LG2-062-160
16 cm, 6 1/4"

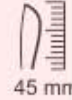

45 mm



LG2-063-160
16 cm, 6 1/4"



50 mm



LG2-064-150
15 cm, 6"



27 mm



LG2-065-150
15 cm, 6"



35 mm



LG2-066-160
16 cm, 6 1/4"

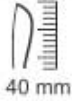

40 mm



LG2-067-160
16 cm, 6 1/4"

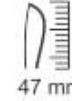

47 mm



LG2-068-170
17 cm, 6 3/4"

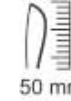

50 mm



DISSECTING KNIVES

Anatomische skalpelle
Bisturías para disección

Bistouris à dissection
Bisturi para dissezione



COLLIN Blade
LG2-069-130 13 cm, 5"
LG2-070-160 16 cm, 6 ¼"
LG2-071-190 19 cm, 7 ½"
LG2-072-220 22 cm, 8 ½"
LG2-073-280 28 cm, 11 ¼"



CATLIN Blade
LG2-074-160 16 cm, 6 ¼"
LG2-075-190 19 cm, 7 ½"
LG2-076-220 22 cm, 8 ½"



LISTON Blade
LG2-077-160 16 cm, 6 ¼"
LG2-078-190 19 cm, 7 ½"
LG2-079-220 22 cm, 8 ½"



LANGENBECK Blade
LG2-080-120 12 cm, 4 ¾"



DIEFFENBACH
LG2-081-130
13 cm, 5"



DIEFFENBACH
LG2-082-130
13 cm, 5"



SIMON
LG2-083-235
23.5 cm, 9 ¼"



Fig. 1
LG2-084-235



Fig. 2
LG2-085-235



Fig. 3
LG2-086-235



Fig. 4
LG2-087-235



DISSECTING KNIVES

Anatomische skalpelle
Bisturías para disección

Bistouris à dissection
Bisturi para dissezione



WALB
LG2-088-001

WALB
LG2-089-002

WALB
LG2-090-003

VIRCHOW
LG2-091-004

VIRCHOW
LG2-092-005

VIRCHOW
LG2-093-006



AMPUTATION & RESECTION

Amputationsmesser, Cuchillos para amputación
Couteaux à amputation, coltelli per amputazione

Resektionsmesser, Cuchillos para resección
Couteaux à résection, Coltelli per resezione



AMPUTATION KNIFE
LG2-094-290
29 cm, 11 1/2"



AMPUTATION KNIFE
LG2-095-325
32.5 cm, 13"



CATLIN
LG2-096-290
29 cm, 11 1/2"



RESECTION KNIFE
LG2-097-180
18 cm, 7"



LANGENBECK
LG2-098-180
18 cm, 7"



LANGENBECK
LG2-099-180
18 cm, 7"



RAZOR
LG2-100-001
Hollow Blades On Both Sides
LG2-101-002
Blade Flat / Hollow

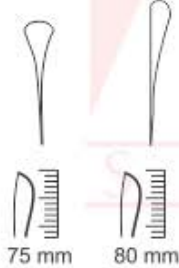

CHARRIERE
LG2-102-270 27 cm, 11"
LG2-103-300 30 cm, 12"



CHARRIERE
LG2-104-350
35 cm, 13 3/4"

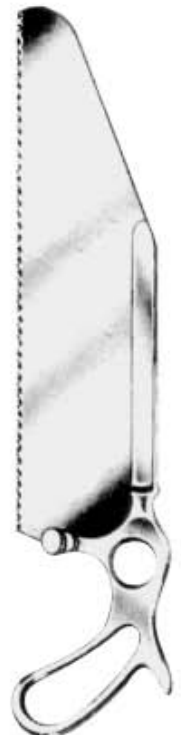

SATTERLEE
LG2-105-310
31 cm, 12 1/4"



SCISSORS





OPERATING SCISSORS

Chirurgische scheren

Tijeras quirúrgicas

Ciseaux chirurgicaux

Forbici per chirurgia



STANDARD STRAIGHT

| | |
|-------------|-----------------|
| LG3-001-115 | 11.5 cm, 4 1/2" |
| LG3-002-130 | 13.0 cm, 5" |
| LG3-003-140 | 14.0 cm, 5 1/2" |
| LG3-004-150 | 15.0 cm, 6" |
| LG3-005-160 | 16.0 cm, 6 1/4" |
| LG3-006-175 | 17.5 cm, 7" |
| LG3-007-185 | 18.5 cm, 7 1/4" |
| LG3-008-200 | 20.0 cm, 8" |

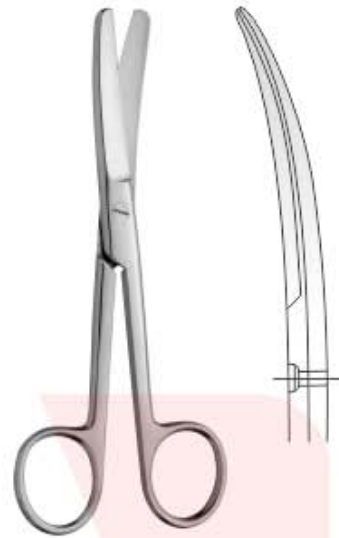

STANDARD CURVED

| | |
|-------------|-----------------|
| LG3-009-115 | 11.5 cm, 4 1/2" |
| LG3-010-130 | 13.0 cm, 5" |
| LG3-011-140 | 14.0 cm, 5 1/2" |
| LG3-012-150 | 15.0 cm, 6" |
| LG3-013-160 | 16.0 cm, 6 1/4" |
| LG3-014-175 | 17.5 cm, 7" |
| LG3-015-185 | 18.5 cm, 7 1/4" |
| LG3-016-200 | 20.0 cm, 8" |



STANDARD STRAIGHT

| | |
|-------------|-----------------|
| LG3-017-115 | 11.5 cm, 4 1/2" |
| LG3-018-130 | 13.0 cm, 5" |
| LG3-019-140 | 14.0 cm, 5 1/2" |
| LG3-020-150 | 15.0 cm, 6" |
| LG3-021-160 | 16.0 cm, 6 1/4" |
| LG3-022-175 | 17.5 cm, 7" |
| LG3-023-185 | 18.5 cm, 7 1/4" |
| LG3-024-200 | 20.0 cm, 8" |

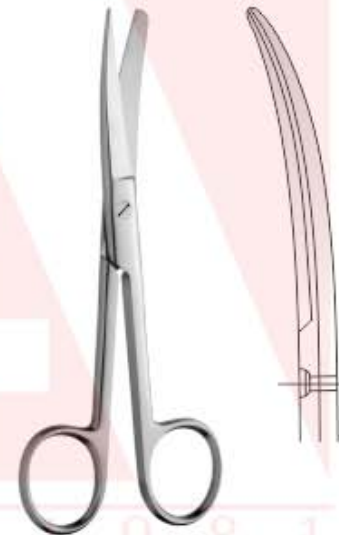

STANDARD CURVED

| | |
|-------------|-----------------|
| LG3-025-115 | 11.5 cm, 4 1/2" |
| LG3-026-130 | 13.0 cm, 5" |
| LG3-027-140 | 14.0 cm, 5 1/2" |
| LG3-028-150 | 15.0 cm, 6" |
| LG3-029-160 | 16.0 cm, 6 1/4" |
| LG3-030-175 | 17.5 cm, 7" |
| LG3-031-185 | 18.5 cm, 7 1/4" |
| LG3-032-200 | 20.0 cm, 8" |

S I N C E 1 9 8 1

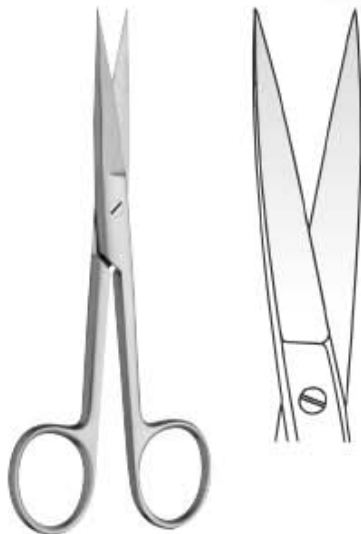

STANDARD STRAIGHT

| | |
|-------------|-----------------|
| LG3-033-115 | 11.5 cm, 4 1/2" |
| LG3-034-130 | 13.0 cm, 5" |
| LG3-035-140 | 14.0 cm, 5 1/2" |
| LG3-036-150 | 15.0 cm, 6" |
| LG3-037-160 | 16.0 cm, 6 1/4" |
| LG3-038-175 | 17.5 cm, 7" |
| LG3-039-185 | 18.5 cm, 7 1/4" |
| LG3-040-200 | 20.0 cm, 8" |

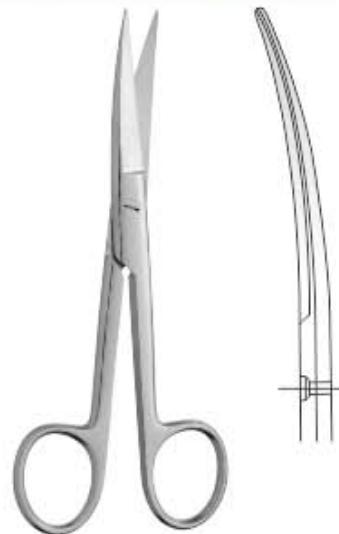

STANDARD CURVED

| | |
|-------------|-----------------|
| LG3-041-115 | 11.5 cm, 4 1/2" |
| LG3-042-130 | 13.0 cm, 5" |
| LG3-043-140 | 14.0 cm, 5 1/2" |
| LG3-044-150 | 15.0 cm, 6" |
| LG3-045-160 | 16.0 cm, 6 1/4" |
| LG3-046-175 | 17.5 cm, 7" |
| LG3-047-185 | 18.5 cm, 7 1/4" |
| LG3-048-200 | 20.0 cm, 8" |



OPERATING SCISSORS

Chirurgische scheren

Tijeras quirúrgicas

Ciseaux chirurgicaux

Forbici per chirurgia



STANDARD STRAIGHT

| | |
|-------------|-----------------|
| LG3-049-115 | 11.5 cm, 4 1/2" |
| LG3-050-130 | 13.0 cm, 5" |
| LG3-051-140 | 14.0 cm, 5 1/2" |
| LG3-052-150 | 15.0 cm, 6" |
| LG3-053-160 | 16.0 cm, 6 1/4" |
| LG3-054-175 | 17.5 cm, 7" |
| LG3-055-185 | 18.5 cm, 7 1/4" |
| LG3-056-200 | 20.0 cm, 8" |

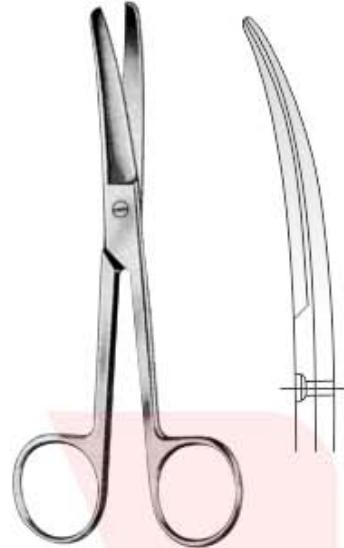

STANDARD CURVED

| | |
|-------------|-----------------|
| LG3-057-115 | 11.5 cm, 4 1/2" |
| LG3-058-130 | 13.0 cm, 5" |
| LG3-059-140 | 14.0 cm, 5 1/2" |
| LG3-060-150 | 15.0 cm, 6" |
| LG3-061-160 | 16.0 cm, 6 1/4" |
| LG3-062-175 | 17.5 cm, 7" |
| LG3-063-185 | 18.5 cm, 7 1/4" |
| LG3-064-200 | 20.0 cm, 8" |



STANDARD STRAIGHT

| | |
|-------------|-----------------|
| LG3-065-115 | 11.5 cm, 4 1/2" |
| LG3-066-130 | 13.0 cm, 5" |
| LG3-067-140 | 14.0 cm, 5 1/2" |
| LG3-068-150 | 15.0 cm, 6" |
| LG3-069-160 | 16.0 cm, 6 1/4" |
| LG3-070-175 | 17.5 cm, 7" |
| LG3-071-185 | 18.5 cm, 7 1/4" |
| LG3-072-200 | 20.0 cm, 8" |



STANDARD CURVED

| | |
|-------------|-----------------|
| LG3-073-115 | 11.5 cm, 4 1/2" |
| LG3-074-130 | 13.0 cm, 5" |
| LG3-075-140 | 14.0 cm, 5 1/2" |
| LG3-076-150 | 15.0 cm, 6" |
| LG3-077-160 | 16.0 cm, 6 1/4" |
| LG3-078-175 | 17.5 cm, 7" |
| LG3-079-185 | 18.5 cm, 7 1/4" |
| LG3-080-200 | 20.0 cm, 8" |



STANDARD STRAIGHT

| | |
|-------------|-----------------|
| LG3-081-115 | 11.5 cm, 4 1/2" |
| LG3-082-130 | 13.0 cm, 5" |
| LG3-083-140 | 14.0 cm, 5 1/2" |
| LG3-084-150 | 15.0 cm, 6" |
| LG3-085-160 | 16.0 cm, 6 1/4" |
| LG3-086-175 | 17.5 cm, 7" |
| LG3-087-185 | 18.5 cm, 7 1/4" |
| LG3-088-200 | 20.0 cm, 8" |



STANDARD CURVED

| | |
|-------------|-----------------|
| LG3-089-115 | 11.5 cm, 4 1/2" |
| LG3-090-130 | 13.0 cm, 5" |
| LG3-091-140 | 14.0 cm, 5 1/2" |
| LG3-092-150 | 15.0 cm, 6" |
| LG3-093-160 | 16.0 cm, 6 1/4" |
| LG3-094-175 | 17.5 cm, 7" |
| LG3-095-185 | 18.5 cm, 7 1/4" |
| LG3-096-200 | 20.0 cm, 8" |

S I N C E 1 9 8 1



OPERATING, DISSECTING SCISSORS

Chirurgische scheren, Präparierscheren
Tijeras quirúrgicas, Tijeras de disección

Ciseaux chirurgicaux, Ciseaux à dissection
Forbici per chirurgia, Forbici per dissezione



GRAZIL
B/B

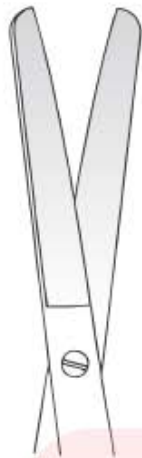

LG3-097-130
13.0 cm, 5"
LG3-098-145
14.5 cm, 5 3/4"
Straight



LG3-099-130
13.0 cm, 5"
LG3-100-145
14.5 cm, 5 3/4"
Curved



GRAZIL
S/B



LG3-101-130
13.0 cm, 5"
LG3-102-145
14.5 cm, 5 3/4"
Straight



LG3-103-130
13.0 cm, 5"
LG3-104-145
14.5 cm, 5 3/4"
Curved



GRAZIL
S/S



LG3-105-130
13.0 cm, 5"
LG3-106-145
14.5 cm, 5 3/4"
Straight



LG3-107-130
13.0 cm, 5"
LG3-108-145
14.5 cm, 5 3/4"
Curved



DEAVER
LG3-109-140
14.0 cm, 5 1/2"
Straight, S/B



LG3-110-140
14.0 cm, 5 1/2"
curved

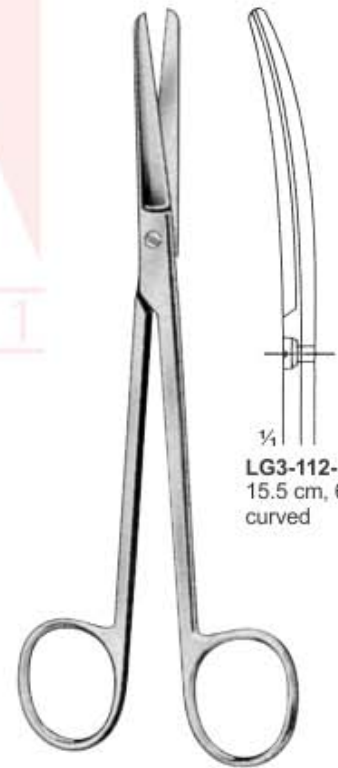

MIXTER
LG3-111-155
15.5 cm, 6"
Straight, S/S



LG3-112-155
15.5 cm, 6"
curved



DISSECTING & GYNECOLOGICAL SCISSORS

Präparierscheren, Gynäkologische Scheren
Tijeras de disección, Tijeras para ginecología

Ciseaux à dissection, ciseaux à gynécologie
Forbici per dissezione, Forbici per ginecologia



INCISION SCISSORS
LG3-113-130 13.0 cm, 5"
LG3-114-145 14.5 cm, 5 ½"



INCISION SCISSORS
LG3-115-155
15.5 cm, 6"



RICHTER
LG3-116-145
14.5 cm, 5 ½"



FERGUSSON
LG3-117-140 14.0 cm, 5 ½"
LG3-118-165 16.5 cm, 6 ½"
LG3-119-180 18.0 cm, 7"



MAYO
LG3-120-145 14.5 cm, 5 ½"
LG3-121-150 15.0 cm, 6"
LG3-122-170 17.0 cm, 6 ¾"
Straight, B/B



LG3-123-145 14.5 cm, 5 ½"
LG3-124-150 15.0 cm, 6"
LG3-125-170 17.0 cm, 6 ¾"
Curved, B/B



MAYO-STILLE
LG3-126-150 15.0 cm, 6"
LG3-127-170 17.0 cm, 6 ¾"
Straight, B/B



LG3-128-150
15.0 cm, 6"
LG3-129-170
17.0 cm, 6 ¾"
Curved, B/B



MAYO-NOBLE



LG3-130-170
17.0 cm, 6 ¾"
Straight

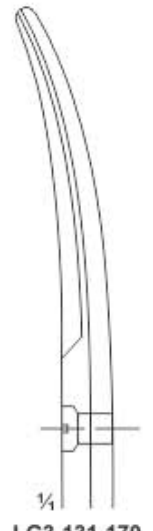

LG3-131-170
17.0 cm, 6 ¾"
Curved



OPERATING, DISSECTING SCISSORS

Chirurgische scheren, Präparierscheren
Tijeras quirúrgicas, Tijeras de disección

Ciseaux chirurgicaux, Ciseaux à dissection
Forbici per chirurgia, Forbici per dissezione



- LG3-131-145 14.5 cm, 5 3/4"
- LG3-132-180 18.0 cm, 7"
- LG3-133-200 20.0 cm, 8"
- LG3-134-230 23.0 cm, 9"
- LG3-135-250 25.0 cm, 10"
- LG3-136-280 28.0 cm, 11"

METZENBAUM
Blunt / Blunt
Straight



- LG3-137-180 14.5 cm, 5 3/4"
- LG3-138-180 18.0 cm, 7"
- LG3-139-200 20.0 cm, 8"
- LG3-140-230 23.0 cm, 9"
- LG3-141-250 25.0 cm, 10"
- LG3-142-280 28.0 cm, 11"

METZENBAUM
Blunt / Blunt
Curved



METZENBAUM-JAMISON
LG3-143-152
15.25 cm, 6"

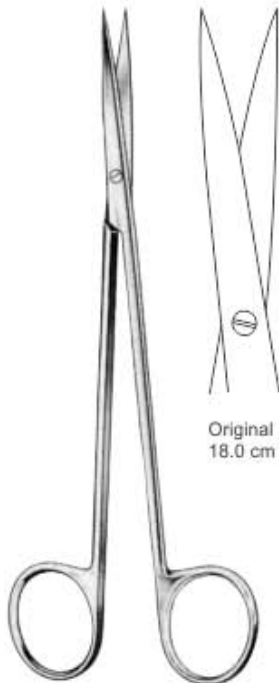

Original
18.0 cm

- METZENBAUM**
Sharp/Sharp, Str.
- LG3-144-145 14.5 cm, 5 1/2"
 - LG3-145-180 18.0 cm, 7"
 - LG3-146-200 20.0 cm, 8"
 - LG3-147-230 23.0 cm, 9"
 - LG3-148-250 25.0 cm, 10"
 - LG3-149-280 28.0 cm, 11"
 - LG3-150-300 30.0 cm, 12"

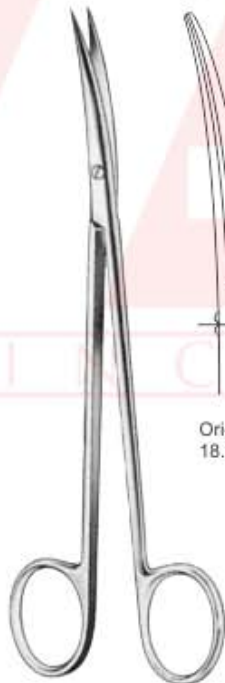

Original
18.0 cm

- METZENBAUM**
Sharp/Sharp, Cvd.
- LG3-151-145 14.5 cm, 5 1/2"
 - LG3-152-180 18.0 cm, 7"
 - LG3-153-200 20.0 cm, 8"
 - LG3-154-230 23.0 cm, 9"
 - LG3-155-250 25.0 cm, 10"
 - LG3-156-280 28.0 cm, 11"
 - LG3-157-300 30.0 cm, 12"

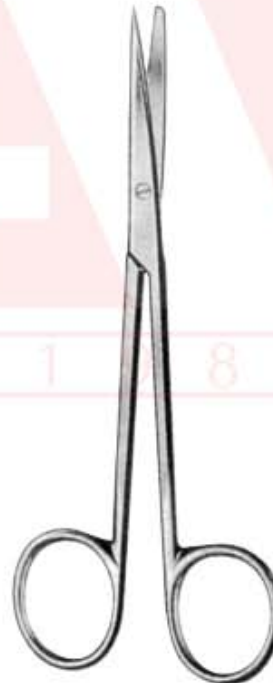

- METZENBAUM**
Sharp/Blunt, Str.
- LG3-158-145 14.5 cm, 5 1/2"
 - LG3-159-180 18.0 cm, 7"
 - LG3-160-200 20.0 cm, 8"
 - LG3-161-230 23.0 cm, 9"
 - LG3-162-250 25.0 cm, 10"
 - LG3-163-280 28.0 cm, 11"
 - LG3-164-300 30.0 cm, 12"

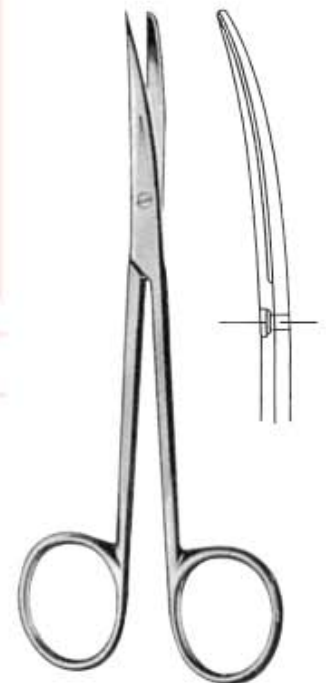

- METZENBAUM**
Sharp/Blunt, Cvd.
- LG3-165-145 14.5 cm, 5 1/2"
 - LG3-166-180 18.0 cm, 7"
 - LG3-167-200 20.0 cm, 8"
 - LG3-168-230 23.0 cm, 9"
 - LG3-169-250 25.0 cm, 10"
 - LG3-170-280 28.0 cm, 11"
 - LG3-171-300 30.0 cm, 12"



FACE-LIFE, DISSECTING, NASAL SCISSORS

Face-lift, Präparierscheren, Nasenscheren
face-Lift, Tijeras de disección, Tijeras nasales

Face-lift, Ciseaux à dissection, Ciseaux nasaux
Face-lift, Forbici per dissezione, Forbici nasali



METZENBAUM DISSECTING
LG3-172-203 20.3 cm, 8"
LG3-173-229 22.9 cm, 9"
LG3-174-284 28.4 cm, 11"
Curved



METZENBAUM-BABY
LG3-175-115
11.5 cm, 4 1/2"
Straight

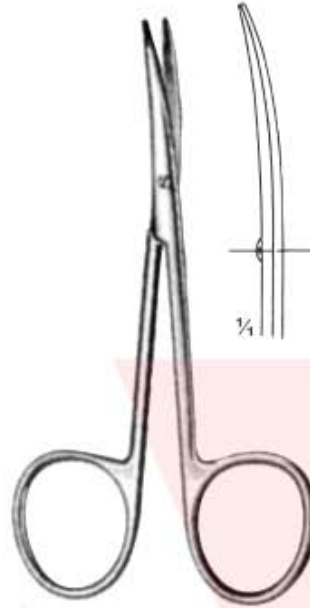

METZENBAUM-BABY
LG3-176-115
11.5 cm, 4 1/2"
Curved

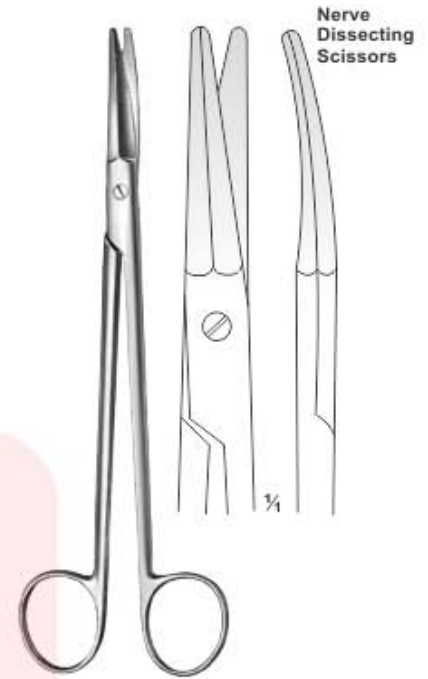

KAYE FACE-LIFT SCISSORS
LG3-177-185
18.5 cm, 7 1/4"

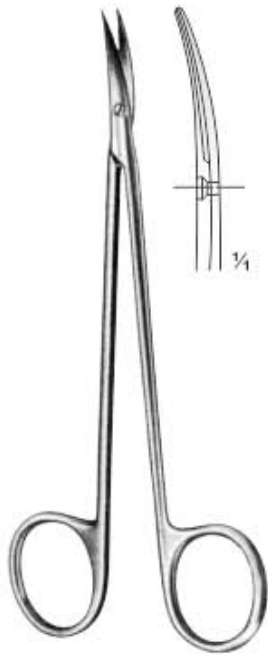

Straight
LG3-178-150
15.0 cm, 6"



Curved
LG3-179-150
15.0 cm, 6"



LEXER
LG3-180-160
16.0 cm, 6 1/4"



LEXER
LG3-181-160
16.0 cm, 6 1/4"



THOREK-FELDMAN
Gall Bladder Scissor
LG3-182-180
18.0 cm, 7"



LEXER-BABY
LG3-183-100
10.0 cm, 4"



OPERATING, DISSECTING SCISSORS

Chirurgische scheren, Präparierscheren
Tijeras quirúrgicas, Tijeras de disección

Ciseaux chirurgicaux, Ciseaux à dissection
Forbici per chirurgia, Forbici per dissezione

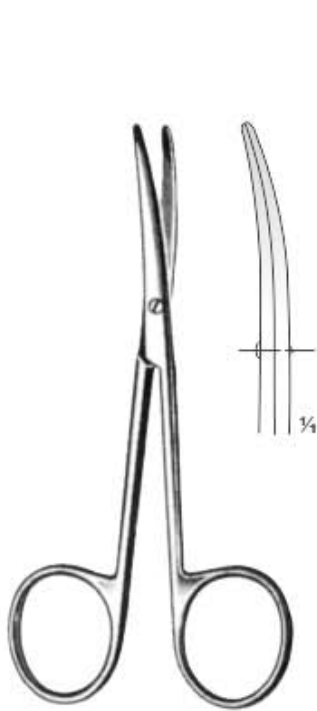

LEXER-BABY
LG3-184-100
10.0 cm, 4"

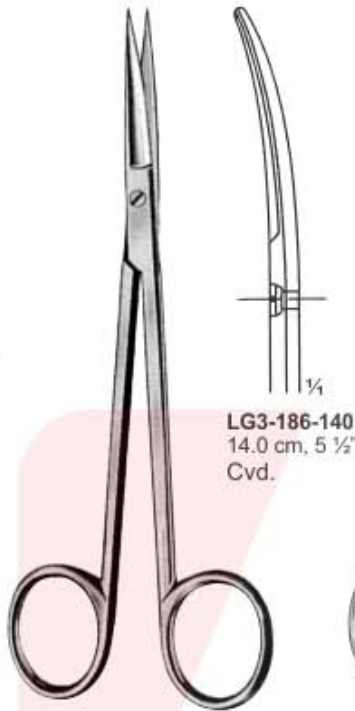

LG3-186-140
14.0 cm, 5 1/2"
Cvd.

SANVENERO
LG3-185-140
14.0 cm, 5 1/2"
Str.



LG3-188-140
14.0 cm, 5 1/2"
Cvd.

JOSEPH
LG3-187-140
14.0 cm, 5 1/2"
Str.

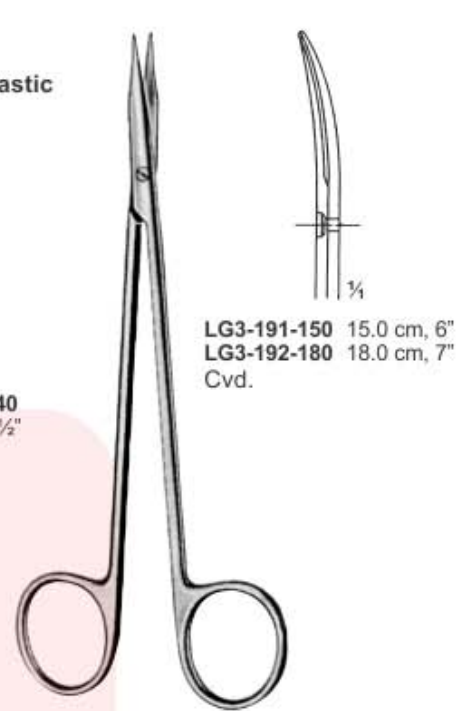

LG3-191-150 15.0 cm, 6"
LG3-192-180 18.0 cm, 7"
Cvd.

REYNOLDS
LG3-189-150 15.0 cm, 6"
LG3-190-180 18.0 cm, 7"
Str.



Plastic

KILNER
LG3-193-120 12.0 cm, 4 3/4"
LG3-194-150 15.0 cm, 6"
LG3-195-180 18.0 cm, 7"
LG3-196-200 20.0 cm, 8"
Str.



LG3-197-120 12.0 cm, 4 3/4"
LG3-198-150 15.0 cm, 6"
LG3-199-180 18.0 cm, 7"
LG3-200-200 20.0 cm, 8"
Cvd.

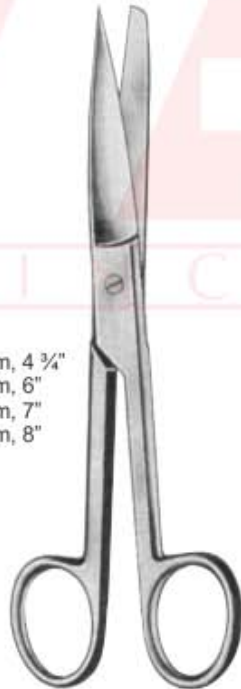

DOYEN
LG3-201-160
16.0 cm, 6 1/4"
S/B, Str.



DOYEN
LG3-202-160
16.0 cm, 6 1/4"
B/B, Str.



LG3-203-160
16.0 cm, 6 1/4"
B/B, Cvd.



DOYEN
LG3-204-175
17.5 cm, 6 3/4"
B/B, Str.

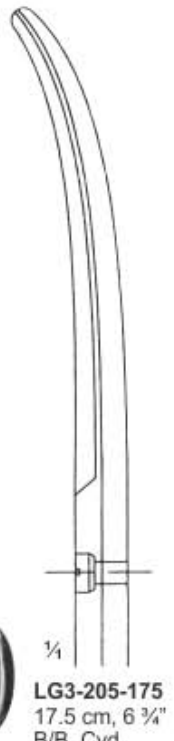

LG3-205-175
17.5 cm, 6 3/4"
B/B, Cvd.



DISSECTING & GYNECOLOGICAL SCISSORS

Präparierscheren, Gynäkologische Scheren
Tijeras de disección, Tijeras para ginecología

Ciseaux à dissection, ciseaux à gynécologie
Forbici per dissezione, Forbici per ginecologia



SIMS
LG3-206-200 20.0 cm, 8"
LG3-207-230 23.0 cm, 9"
Straight, B/B



LG3-208-200
20.0 cm, 8"
LG3-209-230
23.0 cm, 9"
S/B



LG3-210-200
20.0 cm, 8"
LG3-211-230
23.0 cm, 9"
S/S

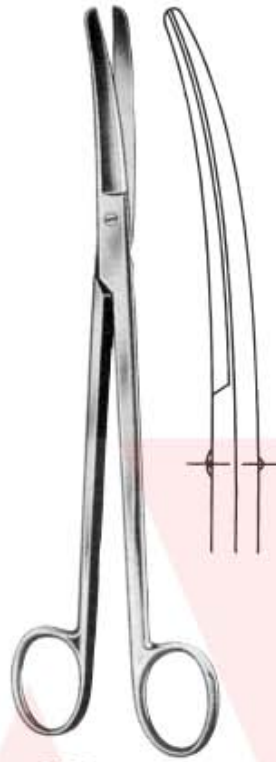

SIMS
LG3-212-200 20.0 cm, 8"
LG3-213-230 23.0 cm, 9"
Curved, B/B



LG3-214-200
20.0 cm, 8"
LG3-215-230
23.0 cm, 9"
S/B



LG3-216-200
20.0 cm, 8"
LG3-217-230
23.0 cm, 9"
S/S



KELLY
LG3-218-160 16.0 cm, 6 ¼"
LG3-219-180 18.0 cm, 7"
Str.



LG3-220-160
16.0 cm, 6 ¼"
LG3-221-180
18.0 cm, 7"
Curved



DUBOIS
LG3-222-270
27.0 cm, 10 ¾"



VEZIEN
LG3-223-180
18.0 cm, 7"



WETHEIM
LG3-224-145 14.5 cm, 5 ¾"
LG3-225-195 19.5 cm, 7 ¾"
LG3-226-225 22.5 cm, 8 ¾"





IRIS, TENDON SCISSORS

Irisscheren, Schnenscheren

Tijeras para Iridectomía, Tijeras para tendones

Ciseaux à iridectomie, Ciseaux à Ténotomie

Forbici per iridectomia, Forbici per tenotomia



LITTLER

LG3-227-115
11.5 cm, 4 ½"
Curved,
sharp/sharp



LG3-228-140
14 cm, 5 ½"
Curved,
sharp/sharp



STRABISMUS



LG3-229-115
11.5 cm, 4 ½"
Curved, blunt/blunt

LG3-230-115
11.5 cm, 4 ½"
Straight, blunt/blunt



IRIS



LG3-231-100
10 cm, 4"
Large Rings, Straight
Sharp / Sharp
LG3-232-100
10 cm, 4"
Large Rings, Curved
Sharp / Sharp



IRIS

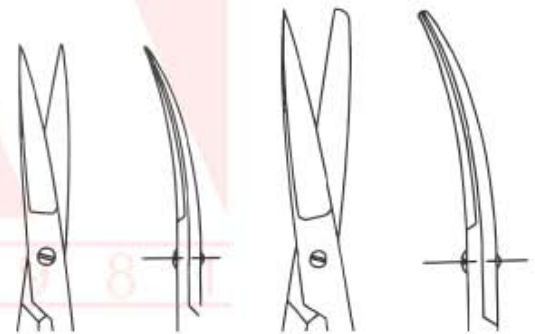

| Item | Description | Tip |
|-------------|------------------------|-------------|
| LG3-233-090 | 09 cm, 3 ½" Straight | Sharp/Sharp |
| LG3-234-105 | 10.5 cm, 4 ¼" Straight | Sharp/Sharp |
| LG3-235-115 | 11.5 cm, 4 ½" Straight | Sharp/Sharp |
| LG3-236-120 | 12.0 cm, 4 ¾" Straight | Sharp/Sharp |
| LG3-237-090 | 09 cm, 3 ½" Curved | Sharp/Blunt |
| LG3-238-105 | 10.5 cm, 4 ¼" Curved | Sharp/Blunt |
| LG3-239-115 | 11.5 cm, 4 ½" Curved | Sharp/Blunt |
| LG3-240-120 | 12.0 cm, 4 ¾" Curved | Sharp/Blunt |



IRIS SCISSORS

Irisscheren

Tijeras para Iridectomía

Ciseaux à iridectomie

Forbici per iridectomia



IRIS
LG3-241-110
11cm 4 1/4"
Standard Ring



KNAPP IRIS
LG3-242-102 Straight.
LG3-243-102 Curved
10.2 cm, 4"



WILMER IRIS
LG3-244-089
8.9 cm, 3 1/2"



IRIS
LG3-245-114
11.4 cm, 4 1/2"
Large Ring



LG3-246-115
11.5 cm, 4 1/2"

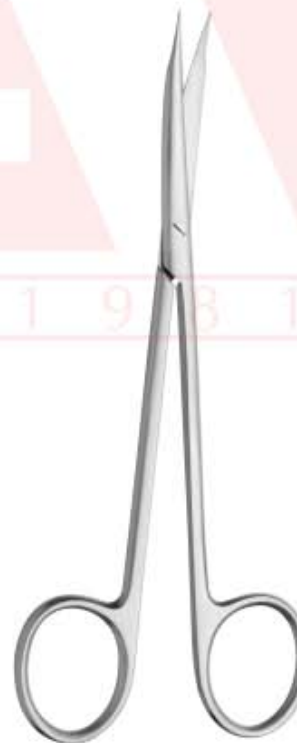

POTTS-REYNOLDS
TENOTOMY
LG3-247-120
12.0 cm, 4 3/4"
Curved



POTTS TENOTOMY
LG3-248-152 15.2 cm, 6"
LG3-249-178 17.8 cm, 7"
LG3-250-203 20.3 cm, 8"



DISSECTING SCISSORS

Präparierscheren
Tijeras de disección

Ciseaux à dissection
Forbici per dissezione



GOLDMAN-FOX
LG3-251-130
13.0 cm, 5"

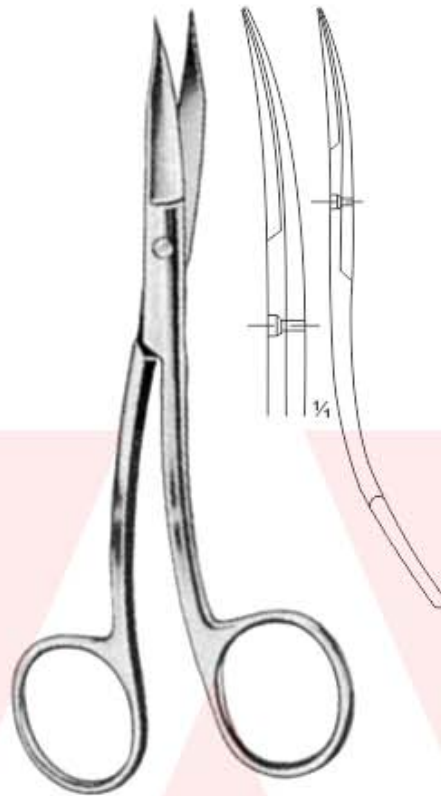

GOLDMAN-FOX (Spezial)
LG3-252-130
13.0 cm, 5"

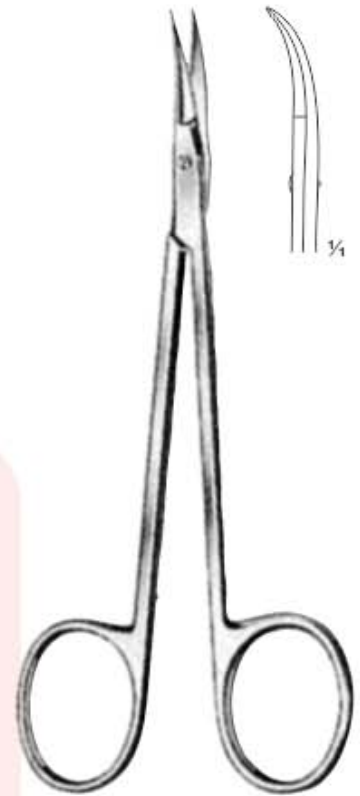

LG3-253-115
11.5 cm, 4 1/2"

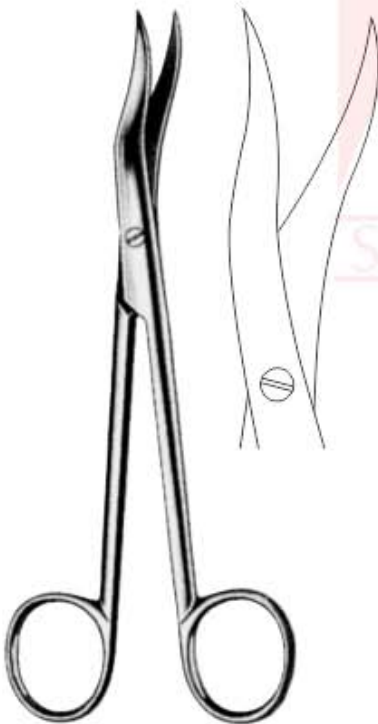

LG3-254-160
16.0 cm, 6 1/4"



LOCKLIN
LG3-255-165
16.5 cm, 6 1/2"

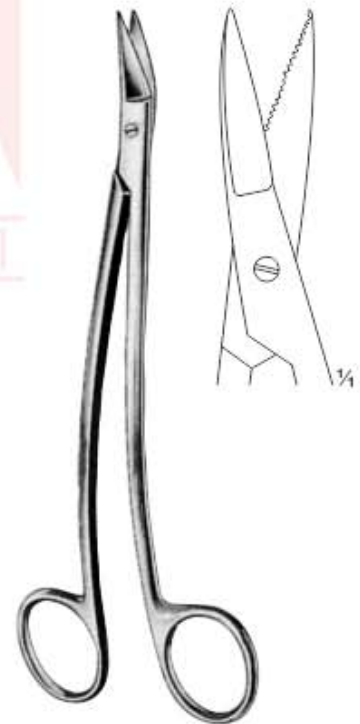

DEAN-DELICATE
LG3-256-170
17.0 cm, 6 3/4"

S I N C E 1 9 8 1



VASCULAR SCISSORS

Gefäßscheren
Tijeras vasculares

Ciseaux vasculaires
Forbici vascolari



HEGEMANN-DIETHRICH



25°
LG3-257-160
16.0 cm, 6 1/4"
LG3-258-190
19.0 cm, 7 1/2"



45°
LG3-259-160
16.0 cm, 6 1/4"
LG3-260-190
19.0 cm, 7 1/2"



60°
LG3-261-160
16.0 cm, 6 1/4"
LG3-262-190
19.0 cm, 7 1/2"



90°
LG3-263-160
16.0 cm, 6 1/4"
LG3-264-190
19.0 cm, 7 1/2"



125°
LG3-265-160
16.0 cm, 6 1/4"
LG3-266-190
19.0 cm, 7 1/2"



Delicate Blade
13 mm

POTTS-SMITH

LG3-267-191 19.1 cm, 7 1/2" angled 25°
LG3-268-133 13.3 cm, 5 1/4" angled 45°
LG3-269-191 19.1 cm, 7 1/2" angled 45°
LG3-270-191 19.1 cm, 7 1/2" angled 60°
LG3-271-191 19.1 cm, 7 1/2" angled 90°



POTTS-SMITH
19.0 cm, 7 1/2"



25°
LG3-272-190



45°
LG3-273-190



60°
LG3-274-190



FULTON
LG3-275-170
17.0 cm, 6 3/4"



HEATH
LG3-276-150
15.0 cm, 6"

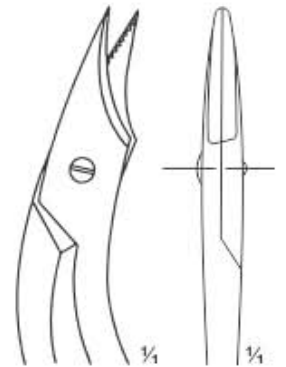



VASCULAR, GUM, OPERATING SCISSORS

Gefäßscheren, Zahnfleischscheren, Chirurgische Scheren
Tijeras vasculares, Tijeras para encías, Tijeras quirúrgicas

Ciseaux vasculaires, Ciseaux à gencives, Ciseaux chirurgicaux
Forbici vascolari, Forbici per gengiva, Forbici per chirurgia

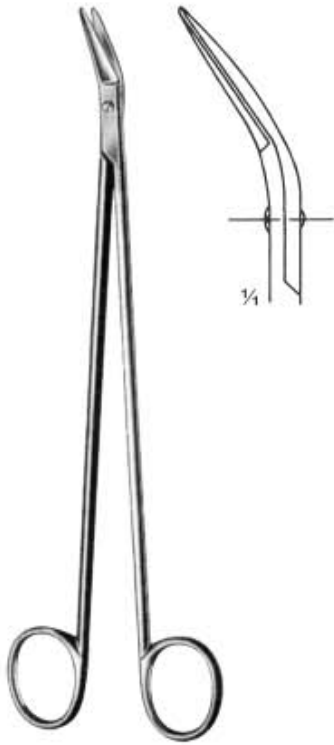

POTTS-SMITH
LG3-277-195
19.5 cm, 7 3/4"



**NELSON LUNG
DISSECTING**
LG3-278-229 Straight
LG3-279-229 Curved
22.9 cm, 9"



MC INDOE
LG3-280-190
19.0 cm, 7 1/2"



DISSECTING
LG3-281-115 11.5 cm, 4 1/4"
LG3-282-130 13.0 cm, 5"
LG3-283-140 14.0 cm, 5 1/2"



HEYMANN
LG3-284-195
19.5 cm, 7 3/4"

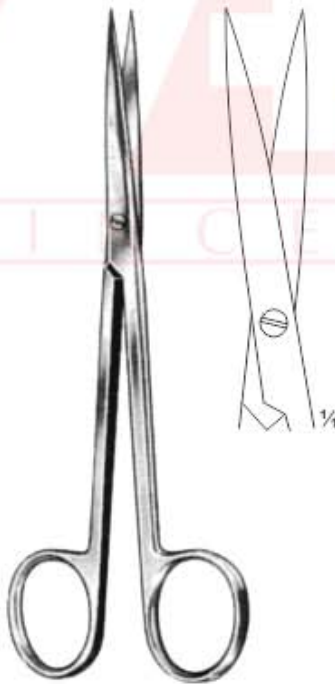

BROPHY (SULLIVAN)
LG3-285-140
14.0 cm, 5 1/2"
Str.

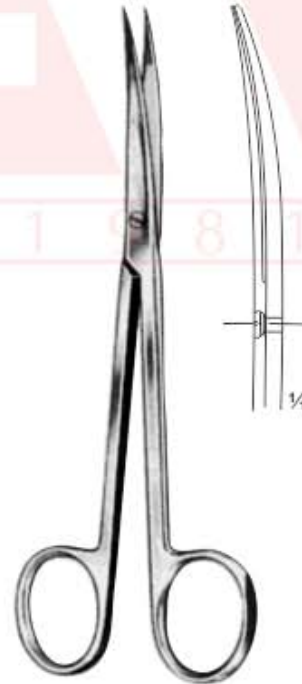

BROPHY (SULLIVAN)
LG3-286-140
14.0 cm, 5 1/2"
Cvd.



OPERATING FINE
LG3-287-120 Straight
LG3-288-120 Curved
12 cm, 4 3/4"



GUM & STITCH SCISSORS

Zahnfleischscheren, Fadenscheren,
Tijeras para encías, Tijeras para hilos,

Ciseaux à gencives, Ciseaux à ligatures,
Forbici per gengiva, Forbici per legature,



WALTON
LG3-289-100
10.0 cm, 4"



LG3-290-105
10.5 cm, 4"
LG3-291-115
11.5 cm, 4 1/2"



LG3-292-105
10.5 cm, 4"
LG3-293-115
11.5 cm, 4 1/2"

LG3-294-115
11.5 cm, 4 1/2"

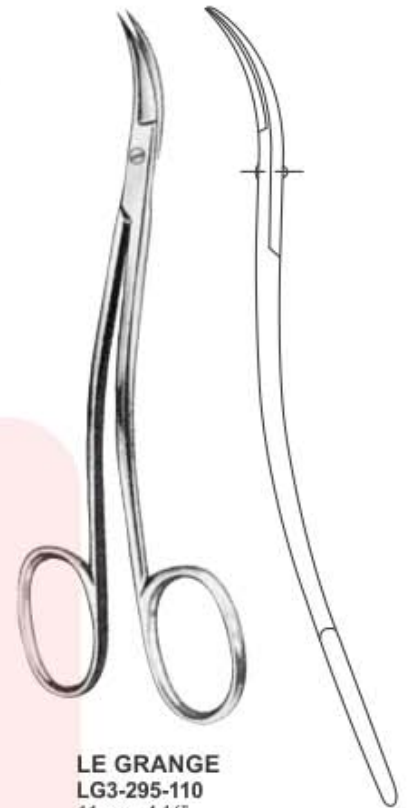

LE GRANGE
LG3-295-110
11 cm, 4 1/4"

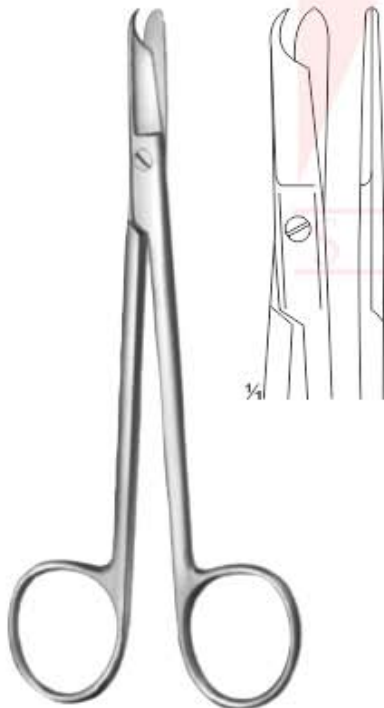

SPENCER
LG3-296-090
9 cm, 3 1/2"



SPENCER / DELICATE
LG3-297-110
11 cm, 4 1/2"



LITTAUER
LG3-298-140
14 cm, 5 1/2"



WIRE CUTTING SCISSORS, SCISSORS

Drahtscheren

Tijeras para alambres

Cisailles à fils

Forbici per filo metallico

Saw Edge

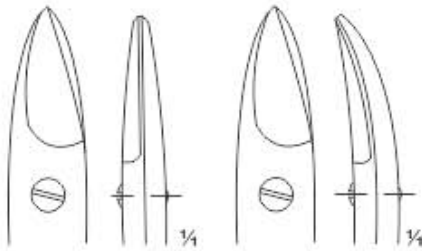

LG3-299-120
12.0 cm, 4 3/4"
Straight

LG3-300-120
12.0 cm, 4 3/4"
Curved



BEEBEE

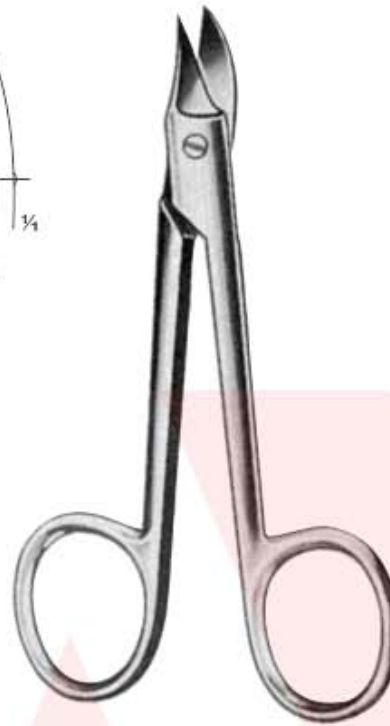

BEEBEE
LG3-301-105
10.5 cm, 4"



WIRE CUTTING
LG3-302-115
11.5 cm, 4 1/2"



NAIL SCISSORS
LG3-303-090
9 cm, 3 1/2"
Curved



NAIL SCISSORS
LG3-304-090
9 cm, 3 1/2"
Curved



NAIL SCISSORS
LG3-305-090
9 cm, 3 1/2"
Arrow Point
Curved

S I N C E 1 9 8 1



MICRO SCISSORS

Mikroscheren

Micro scissors

Micro-Ciseaux

Micro-Forbici

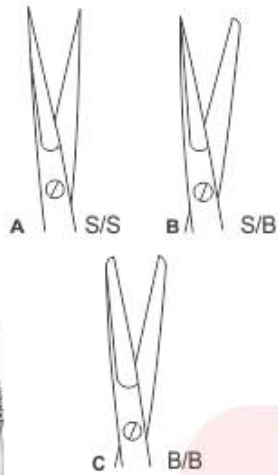

NOYES
A LG3-306-120
B LG3-307-120
C LG3-308-120
12 cm, 4 3/4"



NOYES
LG3-309-120
12 cm, 4 3/4"



WECKER
11.0 cm, 4 1/4"

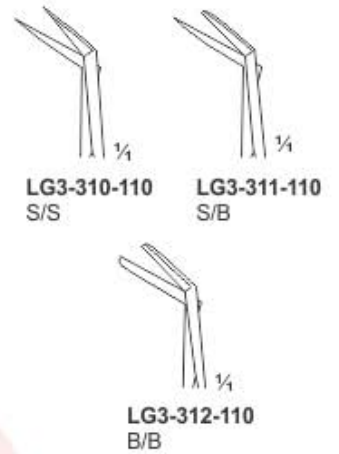

CASTROVIEJO
9.0 cm, 3 1/2"



LG3-313-090
B/B



LG3-314-090
B/B



LG3-315-090
B/S



LG3-316-090
S/S

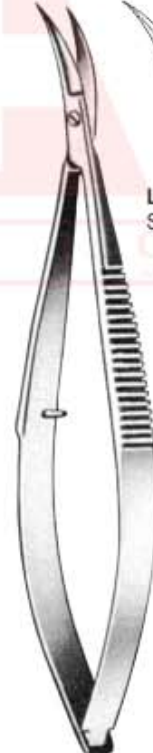

CASTROVIEJO
10.0 cm, 4"



LG3-317-100
Sharp



CASTROVIEJO
10.0 cm, 4"

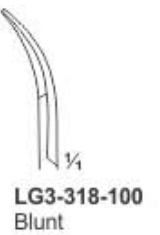

LG3-318-100
Blunt



MICRO SCISSORS

Mikroscheren
Micro scissors

Micro-Ciseaux
Micro-Forbici



WESTCOTT
LG3-319-110
11.0 cm, 4 1/4"



WESTCOTT
LG3-320-110
11.0 cm, 4 1/4"



CASTROVIEJO
LG3-321-100
10.0 cm, 4"



CASTROVIEJO
LG3-322-100
10.0 cm, 4"

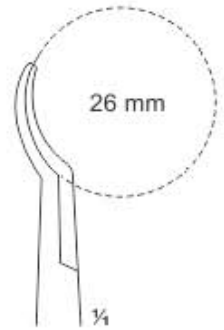

CASTROVIEJO
LG3-323-110
11.0 cm, 4 1/4"



CASTROVIEJO
LG3-324-110
11.0 cm, 4 1/4"



TROUTMAN
LG3-325-100
10.0 cm, 4"



TROUTMAN
LG3-326-100
10.0 cm, 4"

S I N C E 1 9 8 1



MICRO SCISSORS

Mikroscheren
Micro scissors

Micro-Ciseaux
Micro-Forbici



NOYES
LG3-327-150
15.0 cm, 6"



MICRO SCISSOR
14 cm, 5 1/2"



DISSECTION
LG3-328-140

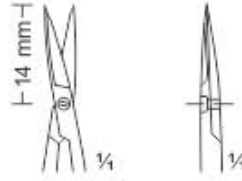

ADVENTITIA
LG3-329-140



MICRO SCISSOR
LG3-330-180
18 cm, 7"



LG3-331-120
12.0 cm, 4 3/4"



WESTCOTT
LG3-332-115
11.5 cm, 4 1/2"



WESTCOTT
LG3-333-115
11.5 cm, 4 1/2"



WESTCOTT



LG3-334-110
11 cm, 4 1/4"
Curved
Sharp/Sharp
LG3-335-110
11 cm, 4 1/4"
Curved-Micro
Sharp/Sharp

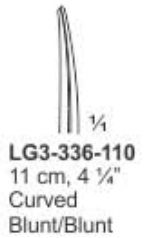

LG3-336-110
11 cm, 4 1/4"
Curved
Blunt/Blunt

SINCE 198



MICRO SCISSORS

Mikroscheren
Micro scissors

Micro-Ciseaux
Micro-Forbici

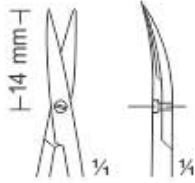

LG3-337-145
14.5 cm, 5 3/4"
Str.
LG3-338-145
14.5 cm, 5 3/4"
Cvd.

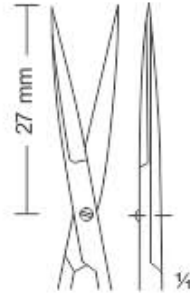

LG3-339-180
18.0 cm, 7"

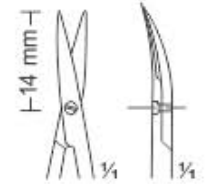

LG3-340-180
18.0 cm, 7" Str.
LG3-341-180
18.0 cm, 7" Cvd.



DISSECTION
LG3-342-180
18 cm, 7" B/B

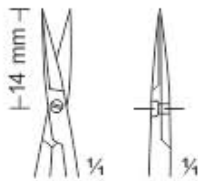

ADVENTITIA
LG3-343-180
18 cm, 7" S/S



16 cm, 6 1/4"
20 cm, 8"
22 cm, 8 3/4"



LG3-344-160
LG3-345-200
LG3-346-220



LG3-347-160
LG3-348-200
LG3-349-220



LG3-350-160
LG3-351-200
LG3-352-220



LG3-353-160
LG3-354-200
LG3-355-220



16 cm, 6 1/4"
20 cm, 8"
22 cm, 8 3/4"

LG3-356-160
LG3-357-200
LG3-358-220



LG3-359-160
LG3-360-200
LG3-361-220

18 cm, 7"



PLASTER SCISSORS

Gipsschere
Tijera para yeso

Ciseaux pour plâtre
Forbici per gesso



LG3-362-200
20 cm, 8"



UNIVERSAL (Colour Available)
LG3-363-145 14.5 cm, 5 3/4"
143 C/290 F Autoclavable
LG3-364-150 15 cm, 6"
143 C/290 F Autoclavable
LG3-365-160 16 cm, 6 1/4"
143 C/290 F Autoclavable
LG3-366-180 18 cm, 7"
143 C/290 F Autoclavable



UNIVERSAL BANDAGE
LG3-367-120
12 cm, 5"

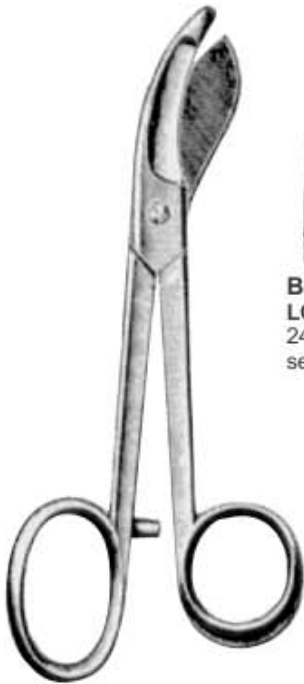

BRUNS
LG3-368-240
24 cm, 9 1/2"
saw edge



BRUNS
LG3-369-240
24 cm, 9 1/2"
serrated



BUSCH
LG3-370-130
13 cm, 5 1/4"
LG3-371-160
16 cm, 6 1/4"



ESMARCH
LG3-372-200
20 cm, 8"
LG3-373-220
22 cm, 8 3/4"



PLASTER SCISSORS

Gipsschere

Tijera para yeso

Ciseaux pour plâtre

Forbici per gesso



BRAUN-STADLER
LG3-374-140
14 cm, 5 1/2"



BRAUN-STADLER
LG3-375-200
20 cm, 8"



MODIFIED-USA
LG3-376-100
10 cm, 4"



SMITH (MOD. USA)
LG3-377-160 16 cm, 6 1/4"
LG3-378-180 18 cm, 7"
LG3-379-200 20 cm, 8"
LG3-380-230 23 cm, 9"



KNOWLES
LG3-381-140
14 cm, 5 1/2"



LISTER
LG3-382-210
21.0 cm, 8 1/4"



LISTER BANDAGE
LG3-383-140 14 cm, 5 1/2"
LG3-384-160 16 cm, 6 1/4"
LG3-385-180 18 cm, 7"
LG3-386-200 20 cm, 8"



UTILITY SHEARS
LG3-387-215
21.5 cm, 8 1/2"
Serrated blade



HAEMOSTATIC FORCEPS

- HAEMOSTATIC FORCEPS
- TOWEL CLAMPS
- TUBING FORCEPS
- SPONGE FORCEPS





HAEMOSTATIC FORCEPS

Arterienklemmen
Pinzas hemostaticas

Pinces hemostatiques
Pinze emostatiche



TUFFIER
LG4-001-130
13.0 cm, 5"

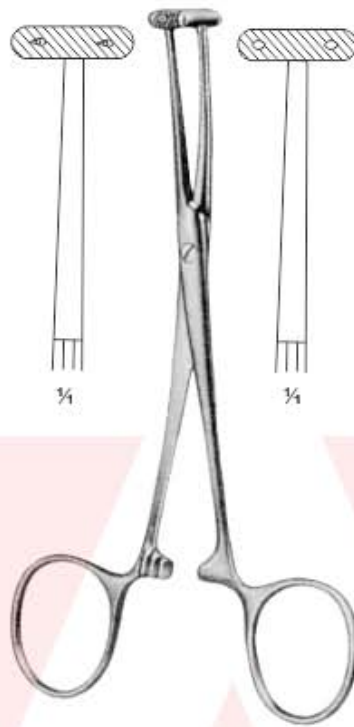

MARTEL
LG4-002-140
14.0 cm, 5 1/2"

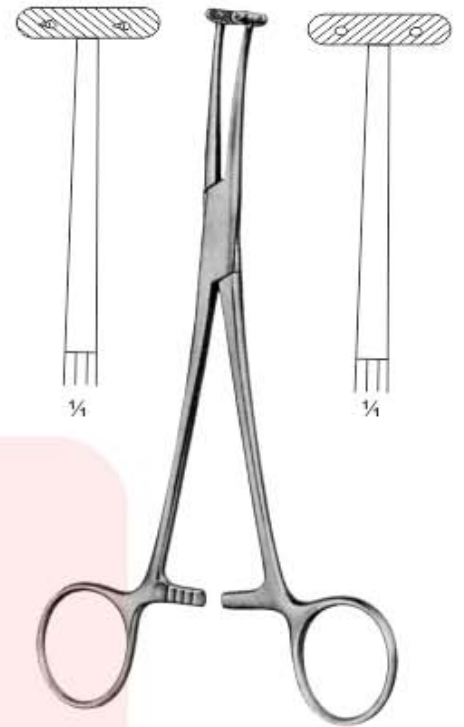

WILLET-MARTEL
LG4-003-190
19.0 cm, 7 1/2"



PRATT

LG4-004-150
15 cm, 4 3/4"
Slight Curve

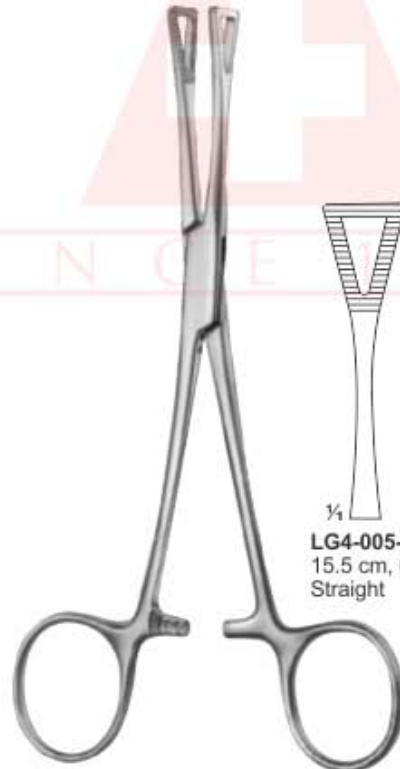

PENNINGTON / SIEZING

LG4-005-155
15.5 cm, 6"
Straight



LG4-006-200
20 cm, 8"
Straight



CHAPUT
LG4-007-130
13.0 cm, 5"



HAEMOSTATIC FORCEPS

Arterienklemmen
Pinzas hemostaticas

Pinces hemostatiques
Pinze emostatiche

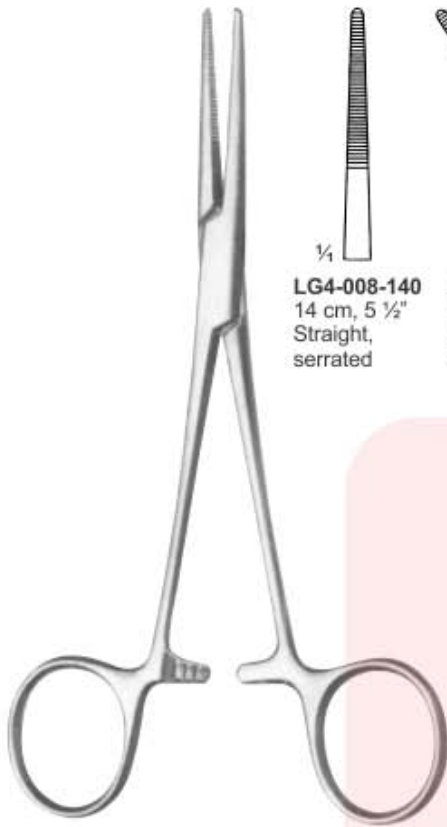

LG4-008-140
14 cm, 5 1/2"
Straight,
serrated

LG4-009-140
14 cm, 5 1/2"
Curved,
serrated

KELLY

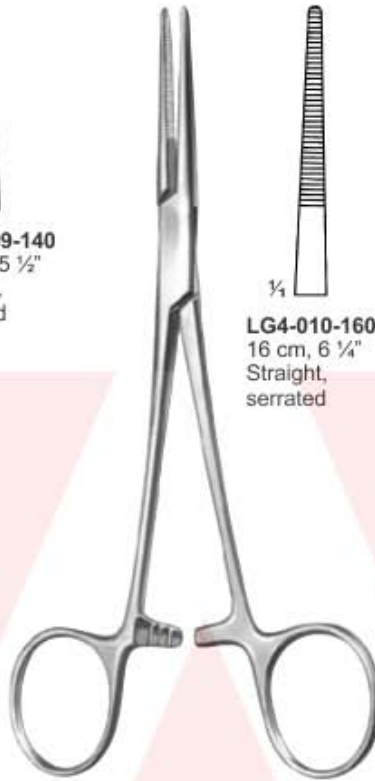

LG4-010-160
16 cm, 6 1/4"
Straight,
serrated

LG4-011-160
16 cm, 6 1/4"
Curved,
serrated

KELLY-RANKIN

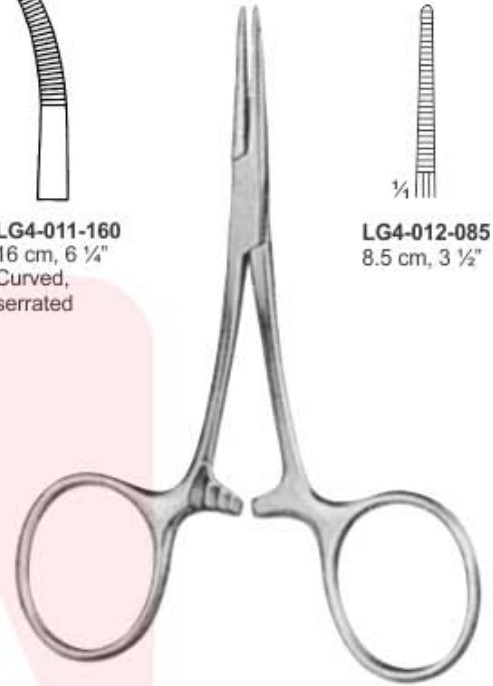

LG4-012-085
8.5 cm, 3 1/2"

CARREL

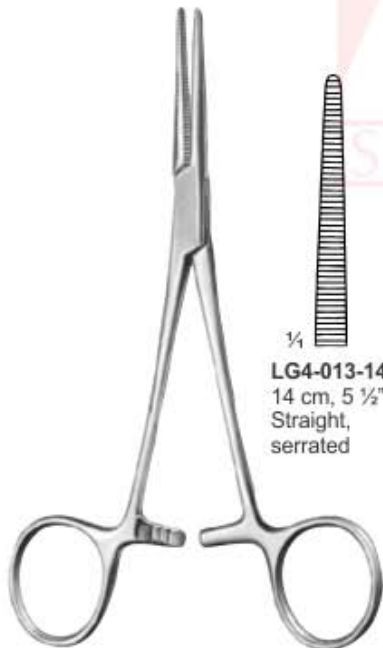

LG4-013-140
14 cm, 5 1/2"
Straight,
serrated

LG4-014-140
14 cm, 5 1/2"
Curved,
serrated

CRILE

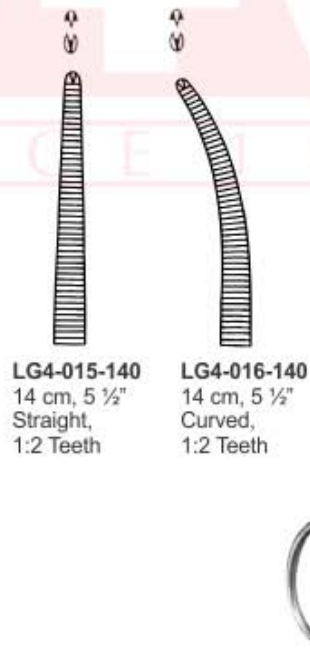

LG4-015-140
14 cm, 5 1/2"
Straight,
1:2 Teeth

LG4-016-140
14 cm, 5 1/2"
Curved,
1:2 Teeth

CRILE-RANKIN

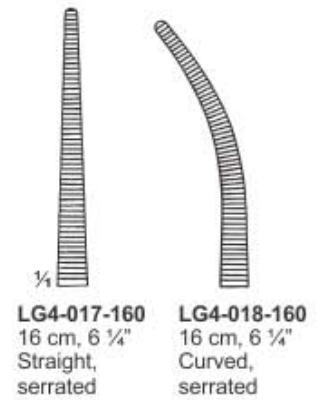

LG4-017-160
16 cm, 6 1/4"
Straight,
serrated

LG4-018-160
16 cm, 6 1/4"
Curved,
serrated



HAEMOSTATIC FORCEPS

Arterienklemmen
Pinzas hemostaticas

Pinces hemostatiques
Pinze emostatiche



LG4-019-180
18 cm, 7"
LG4-020-210
21 cm, 8 1/4"



LG4-021-180
18 cm, 7"
LG4-022-210
21 cm, 8 1/4"

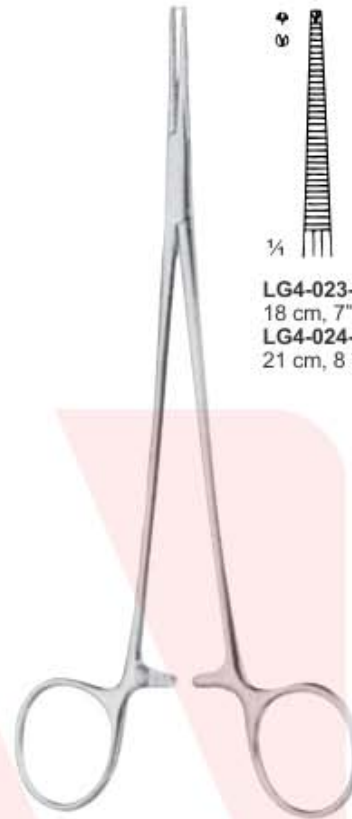

LG4-023-180
18 cm, 7"
LG4-024-210
21 cm, 8 1/4"



LG4-025-180
18 cm, 7"
LG4-026-210
21 cm, 8 1/4"

HALSTED-MOSQUITO

HALSTED-MOSQUITO 1:2



LG4-027-150
15 cm, 6"



LG4-028-150
15 cm, 6"

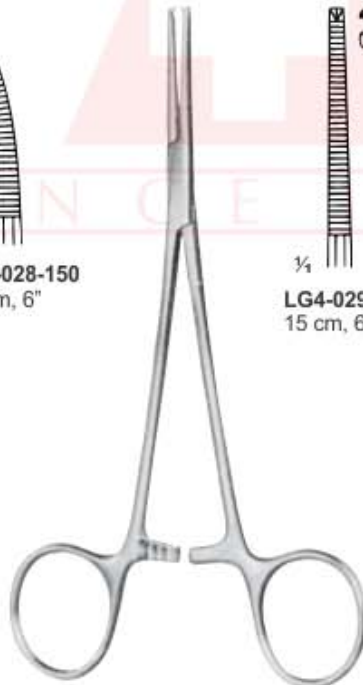

LG4-029-150
15 cm, 6"



LG4-030-150
15 cm, 6"

LERICHE

LERICHE 1:2

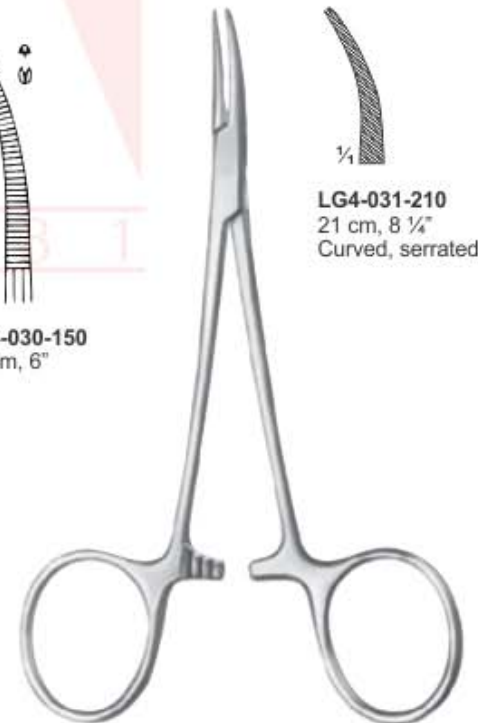

LG4-031-210
21 cm, 8 1/4"
Curved, serrated

VANDERBILT / VESSEL CLAMP



HAEMOSTATIC FORCEPS

Arterienklemmen
Pinzas hemostaticas

Pinces hemostatiques
Pinze emostatiche



**MICRO-MOSQUITO /
PETIT POINT**

LG4-032-100
10 cm, 4"
LG4-033-120
12 cm, 4 3/4"
Straight, serrated



LG4-034-100
10 cm, 4"
LG4-035-120
12 cm, 4 3/4"
Curved, serrated

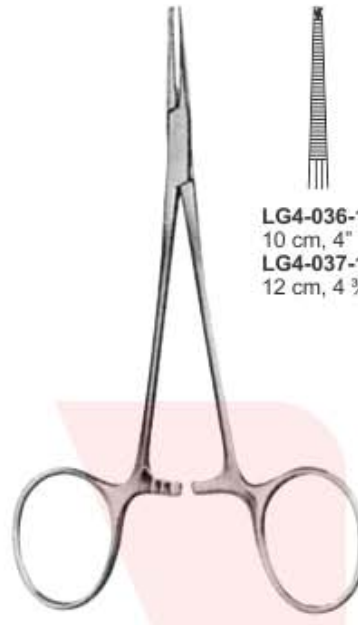

MICRO-MOSQUITO 1:2

LG4-036-100
10 cm, 4"
LG4-037-120
12 cm, 4 3/4"

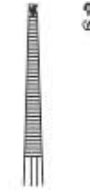

LG4-038-100
10 cm, 4"
LG4-039-120
12 cm, 4 3/4"

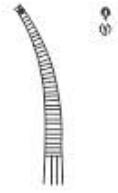

LG4-040-125
12.5 cm, 5"
LG4-041-140
14 cm, 5 1/2"
straight, serrated



LG4-042-180
18 cm, 7"
straight,
serrated



LG4-043-210
21 cm, 8 1/4"
straight,
serrated



LG4-044-125
12.5 cm, 5"
LG4-045-140
14 cm, 5 1/2"
Straight, 1:2 Teeth



LG4-046-180
18 cm, 7"
Straight,
1:2 Teeth



LG4-047-210
21 cm, 8 1/4"
Straight,
1:2 Teeth



HALSTED-MOSQUITO

LG4-048-125
12.5 cm, 5"
LG4-049-140
14 cm, 5 1/2"
Curved,
serrated



LG4-050-180
18 cm, 7"
Curved,
serrated



LG4-051-205
20.5 cm, 8"
Curved,
serrated



LG4-052-125
12.5 cm, 5"
LG4-053-140
14 cm, 5 1/2"
Curved, 1:2 Teeth



LG4-054-180
18 cm, 7"
Curved,
1:2 Teeth



LG4-055-205
20.5 cm, 8"
Curved,
1:2 Teeth





HAEMOSTATIC FORCEPS

Arterienklemmen
Pinzas hemostaticas

Pinces hemostatiques
Pinze emostatiche

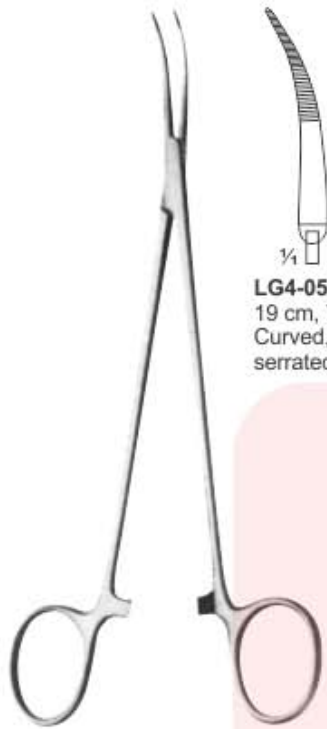

LG4-056-190
19 cm, 7 1/2"
Curved,
serrated

JACOBSON

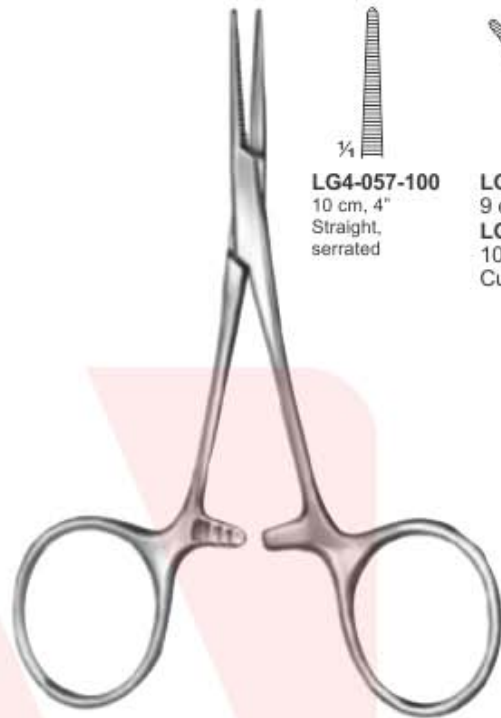

LG4-057-100
10 cm, 4"
Straight,
serrated

LG4-058-090
9 cm, 3 1/2"
LG4-059-100
10 cm, 4"
Curved, Serrated

HARTMANN / MOSQUITO

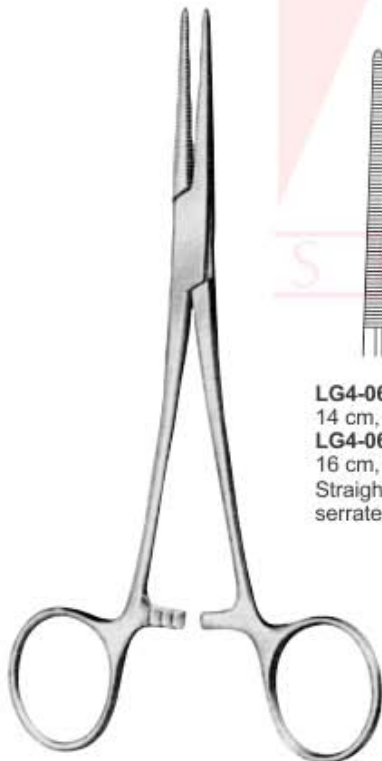

LG4-060-140
14 cm, 5 1/2"
LG4-061-160
16 cm, 6 1/4"
Straight,
serrated

COLLER



LG4-062-140
14 cm, 5 1/2"
LG4-063-160
16 cm, 6 1/4"
Curved,
serrated



LG4-064-130
13 cm, 5"
LG4-065-150
15 cm, 6"
Curved, Serrated

CHRISTOPHE



HAEMOSTATIC FORCEPS

Arterienklemmen
Pinzas hemostaticas

Pinces hemostatiques
Pinze emostatiche

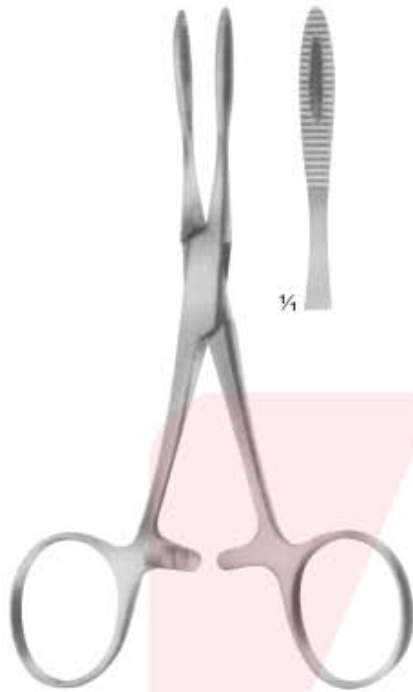

KRONLEIN
LG4-066-130
13 cm, 5"

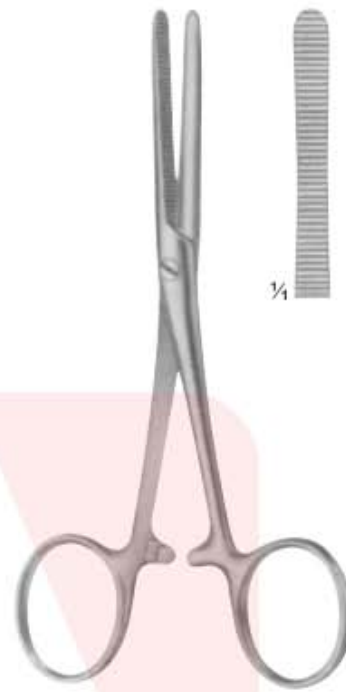

PEAN
LG4-067-125
12.5 cm, 5"



LG4-068-125 **LG4-069-140**
12.5 cm, 5" 14 cm, 5 1/2"

PEAN

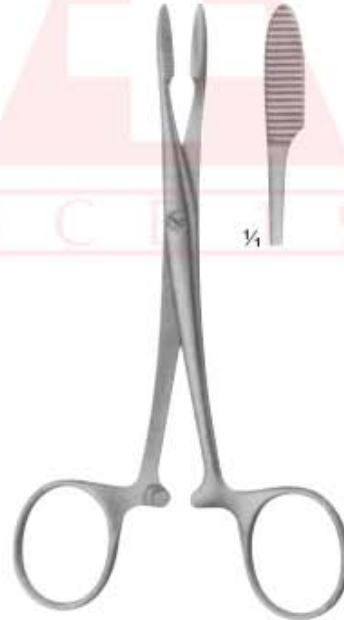

PEAN
LG4-070-165
16.5 cm, 6 3/4"



LG4-071-165 **LG4-072-185**
16.5 cm, 6 3/4" 18.5 cm, 7"

PEAN



HAEMOSTATIC FORCEPS

Arterienklemmen
Pinzas hemostaticas

Pinces hemostatiques
Pinze emostatiche



PEAN - DELICATE

LG4-073-140
14 cm, 5 1/2"
LG4-074-160
16 cm, 6 1/4"
Straight,
Serrated



LG4-075-140
14 cm, 5 1/2"
LG4-076-160
16 cm, 6 1/4"
Curved,
Serrated



PROVIDENCE / HOSPITAL

LG4-077-140
14 cm, 5 1/2"
Straight,
serrated



LG4-078-140
14 cm, 5 1/2"
Curved,
serrated

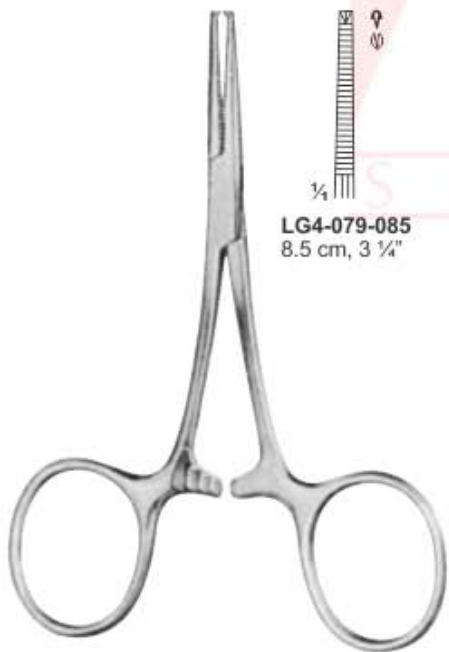

TERRIER 1:2

LG4-079-085
8.5 cm, 3 3/4"



LG4-080-160
16 cm, 6 1/4"
LG4-081-200
20 cm, 8"
Straight,
Cross Serrated



LG4-082-160
16 cm, 6 1/4"
LG4-083-200
20 cm, 8"
Curved,
Cross Serrated



KOCHER / DELICATE

LG4-084-130
13 cm, 5"
LG4-085-140
14 cm, 5 1/2"
LG4-086-160
16 cm, 6 1/4"
Straight, 1:2 Teeth

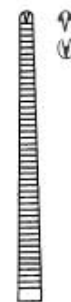

LG4-087-140
14 cm, 5 1/2"
curved,
1:2 Teeth





HAEMOSTATIC FORCEPS

Arterienklemmen
Pinzas hemostaticas

Pinces hemostatiques
Pinze emostatiche

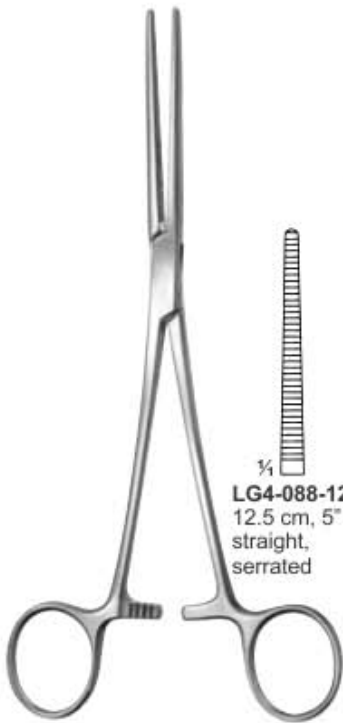

ROCHESTER / PEAN

$\frac{1}{4}$
LG4-088-125
12.5 cm, 5"
straight,
serrated

$\frac{1}{4}$
LG4-089-140
14 cm, 5 ½"
straight,
serrated

$\frac{1}{4}$
LG4-090-160
16 cm, 6 ¼"
straight,
serrated

$\frac{1}{4}$
LG4-091-180
18 cm, 7"
straight,
serrated

$\frac{1}{4}$
LG4-092-200
20 cm, 8"
straight,
serrated

$\frac{1}{4}$
LG4-093-220
22 cm, 8 ¾"
straight,
serrated

$\frac{1}{4}$
LG4-094-240
24 cm, 9 ½"
straight,
serrated

$\frac{1}{4}$
LG4-095-260
26 cm, 10 ¼"
straight,
serrated

$\frac{1}{4}$
LG4-096-300
30 cm, 12"
straight,
serrated



$\frac{1}{4}$
LG4-097-125
12.5 cm, 5"
Curved,
serrated



$\frac{1}{4}$
LG4-098-140
14 cm, 5 ½"
Curved,
serrated



$\frac{1}{4}$
LG4-099-160
16 cm, 6 ¼"
Curved,
serrated



$\frac{1}{4}$
LG4-100-180
18 cm, 7"
Curved,
serrated



$\frac{1}{4}$
LG4-101-200
20 cm, 8"
Curved,
serrated



$\frac{1}{4}$
LG4-102-220
22 cm, 8 ¾"
Curved,
serrated

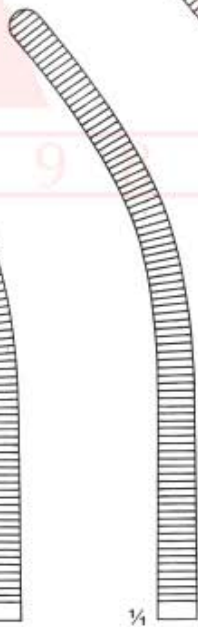

$\frac{1}{4}$
LG4-103-240
24 cm, 9 ½"
Curved,
serrated

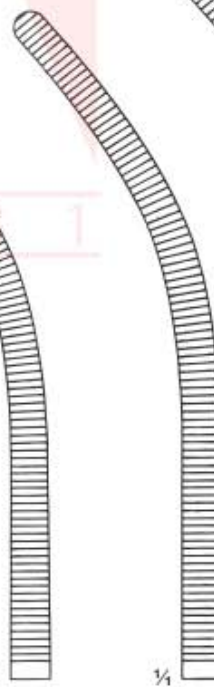

$\frac{1}{4}$
LG4-104-260
26 cm, 10 ¼"
Curved,
serrated

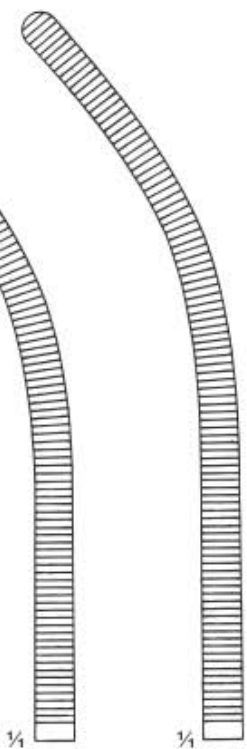

$\frac{1}{4}$
LG4-105-300
30 cm, 12"
Curved,
serrated



HAEMOSTATIC FORCEPS

Arterienklemmen
Pinzas hemostaticas

Pinces hemostatiques
Pinze emostatiche

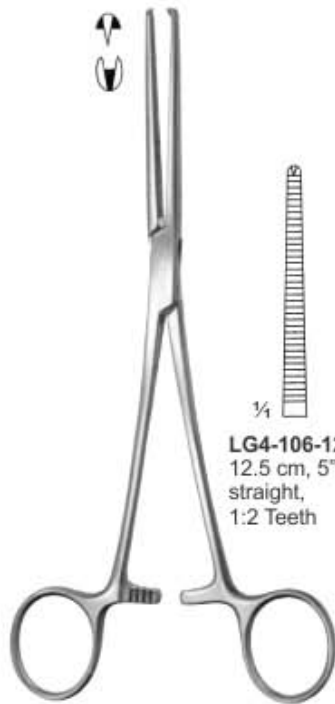

ROCHESTER / OCHSNER / KOCHER

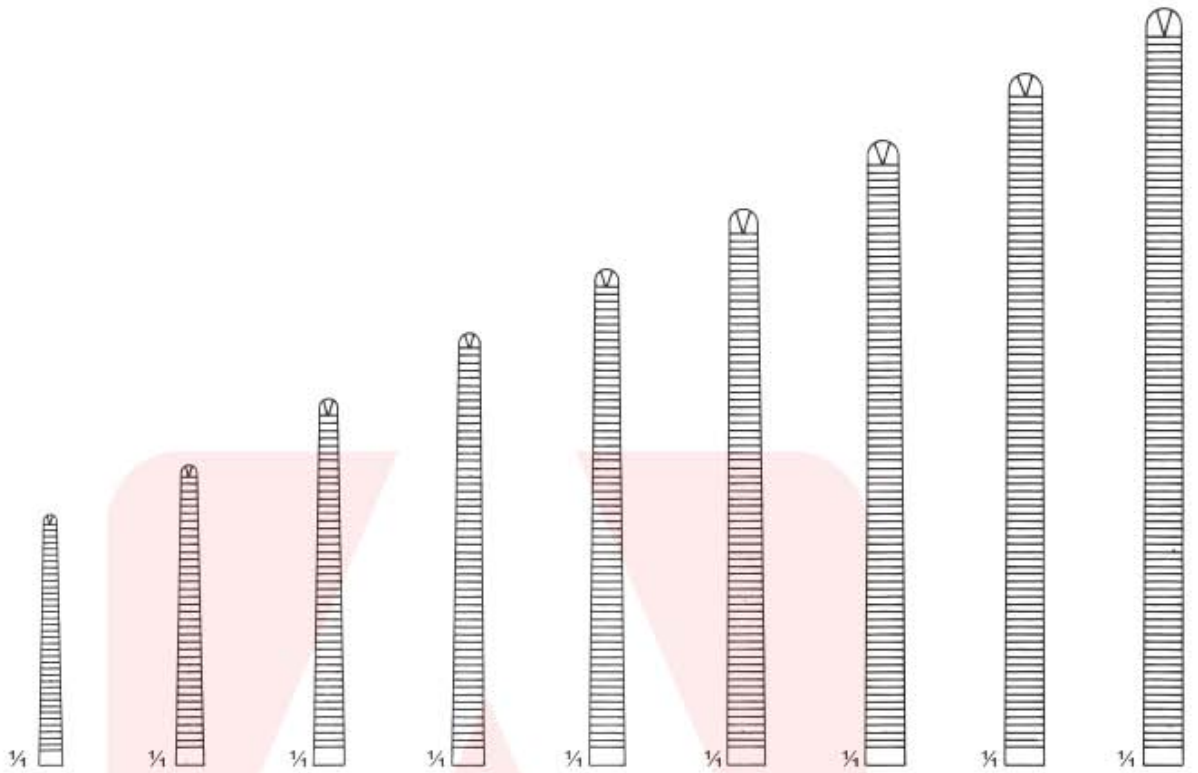

- | | | | | | | | | |
|---|---|---|---|---|---|---|--|--|
| LG4-106-125 12.5 cm, 5" straight, 1:2 Teeth | LG4-107-140 14 cm, 5 1/2" straight, 1:2 Teeth | LG4-108-160 16 cm, 6 1/4" straight, 1:2 Teeth | LG4-109-180 18 cm, 7" straight, 1:2 Teeth | LG4-110-200 20 cm, 8" straight, 1:2 Teeth | LG4-111-220 22 cm, 8 3/4" straight, 1:2 Teeth | LG4-112-240 24 cm, 9 1/2" straight, 1:2 Teeth | LG4-113-260 26 cm, 10 1/4" straight, 1:2 Teeth serrated | LG4-114-300 30 cm, 12" straight, 1:2 Teeth serrated |
|---|---|---|---|---|---|---|--|--|

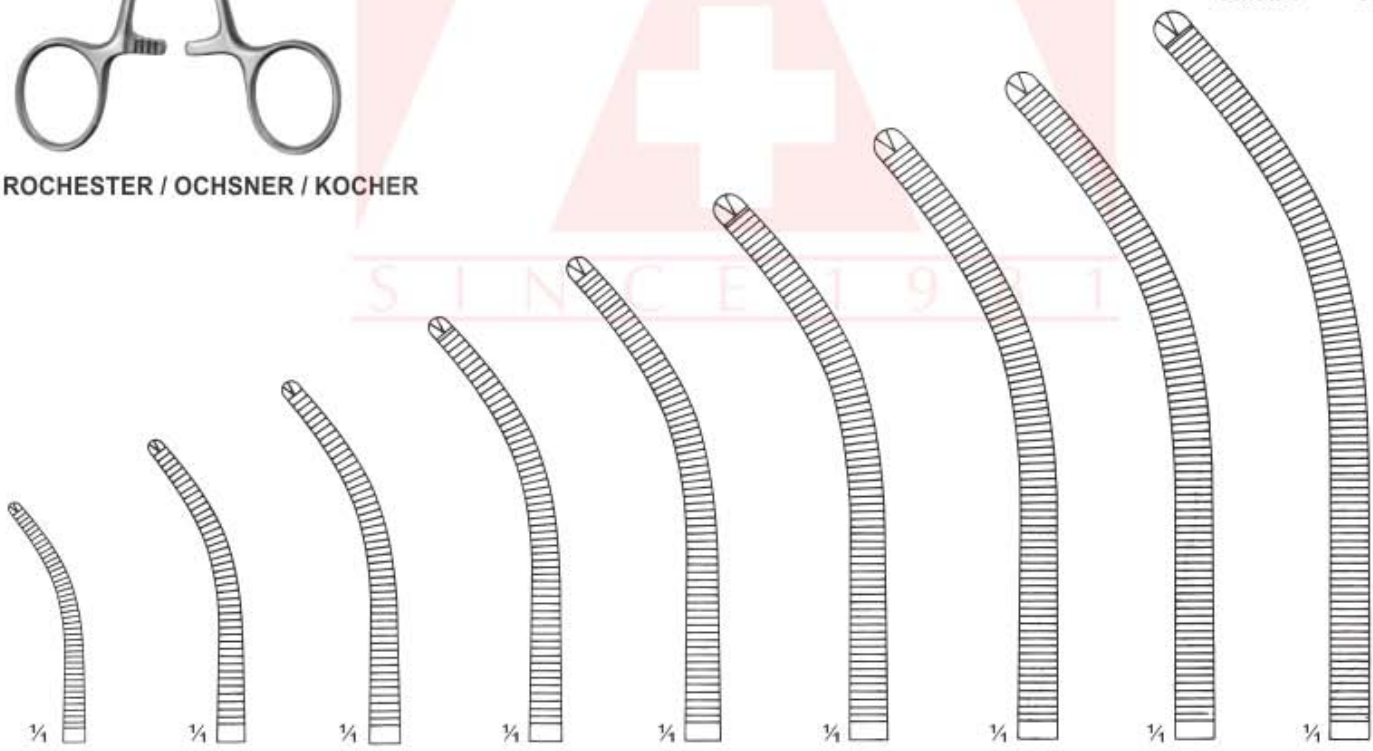

- | | | | | | | | | |
|---|---|---|---|---|---|---|--|--|
| LG4-115-125 12.5 cm, 5" Curved, 1:2 Teeth | LG4-116-140 14 cm, 5 1/2" Curved, 1:2 Teeth | LG4-117-160 16 cm, 6 1/4" Curved, 1:2 Teeth | LG4-118-180 18 cm, 7" Curved, 1:2 Teeth | LG4-119-200 20 cm, 8" Curved, 1:2 Teeth | LG4-120-220 22 cm, 8 3/4" Curved, 1:2 Teeth | LG4-121-240 24 cm, 9 1/2" Curved, 1:2 Teeth | LG4-122-260 26 cm, 10 1/4" Curved, 1:2 Teeth | LG4-123-300 30 cm, 12" Curved, 1:2 Teeth |
|---|---|---|---|---|---|---|--|--|



HAEMOSTATIC FORCEPS

Arterienklemmen
Pinzas hemostaticas

Pinces hemostatiques
Pinze emostatiche



SPENCER-WELLS

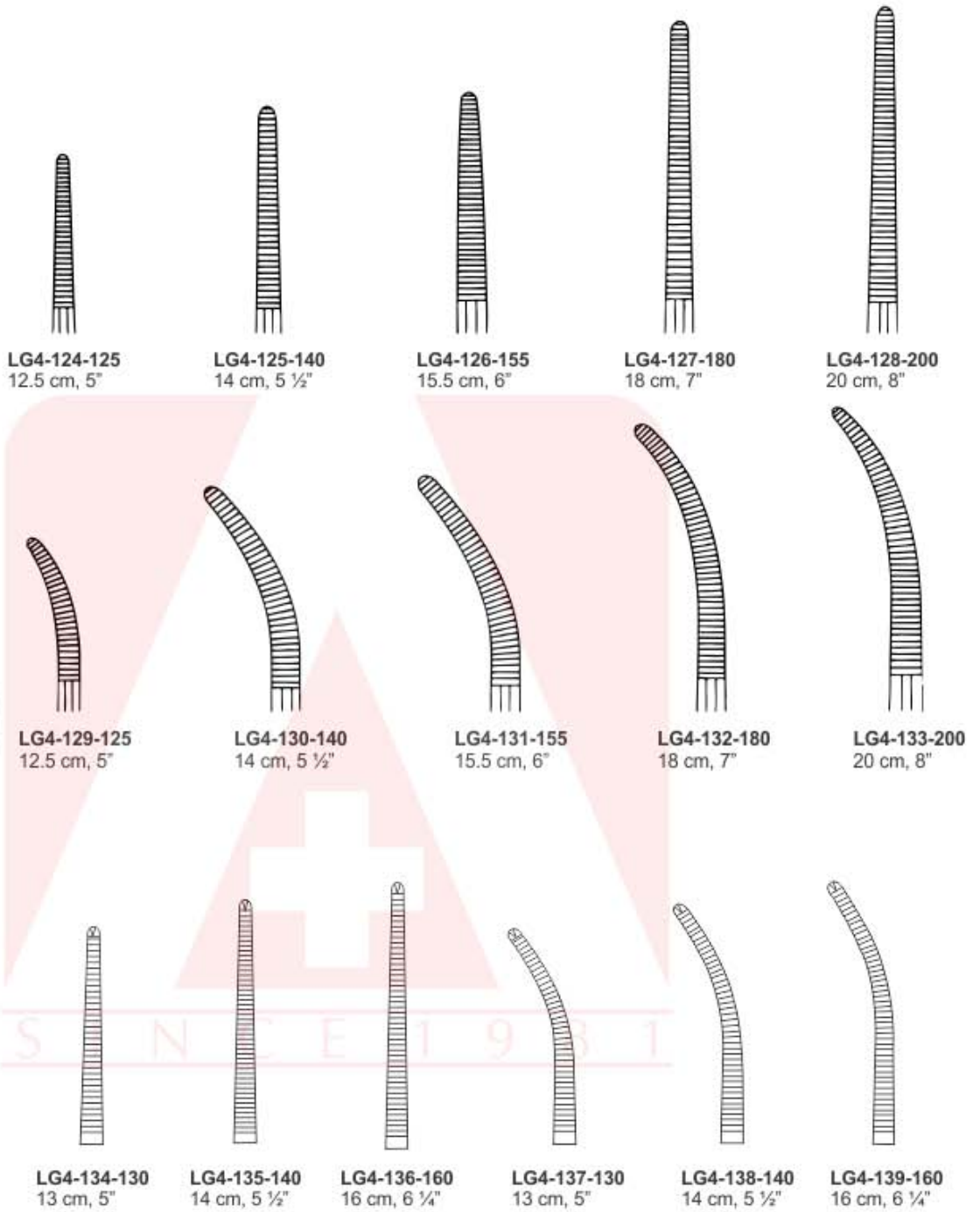

KOCHER
delicate pattern



HAEMOSTATIC FORCEPS

Arterienklemmen
Pinzas hemostaticas

Pinces hemostatiques
Pinze emostatiche



LG4-140-150
15 cm, 6"
LG4-141-200
20 cm, 8"
Curved, Flat
Box Joint.

O'SHAUGNESSY

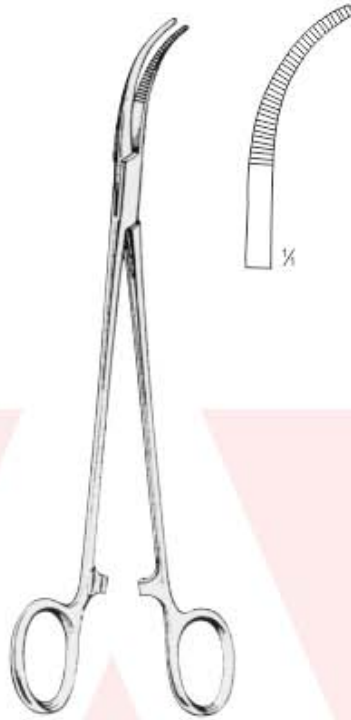

SAWTELL
LG4-142-185 18.5 cm, 7 1/4"
curved on flat joint

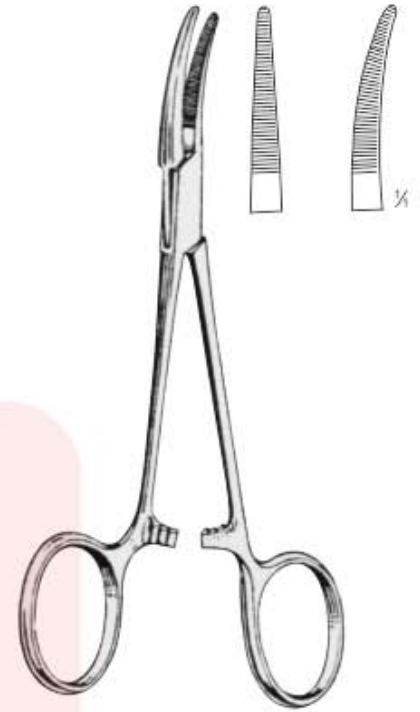

DUNHILL
LG4-143-130
13.0 cm, 5"
Straight, box joint, as
above but curved on flat.



CAIRNS
LG4-144-145
14.5 cm, 5 3/4"
Straight, box joint, as
above but curved on flat.

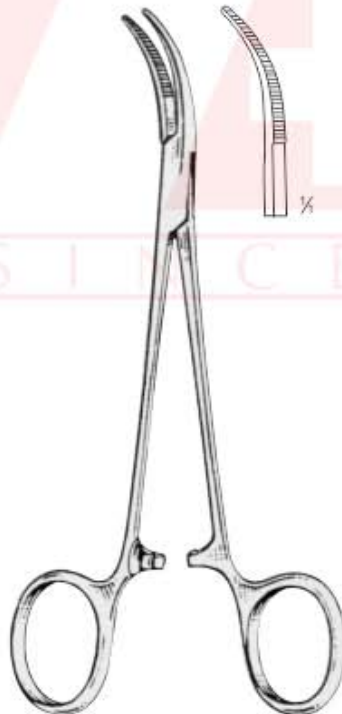

CAIRNS
LG4-145-145
14.5 cm, 5 3/4"
curved laterally,
joint

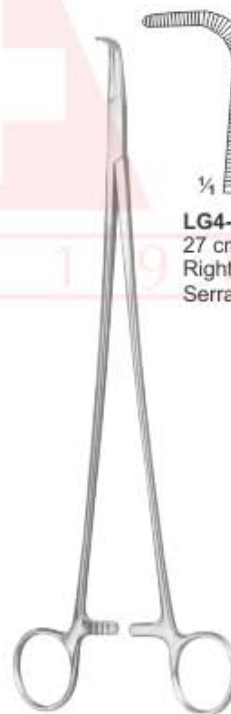

LG4-146-270
27 cm, 10 3/4"
Right Angle,
Serrated

MEEKER

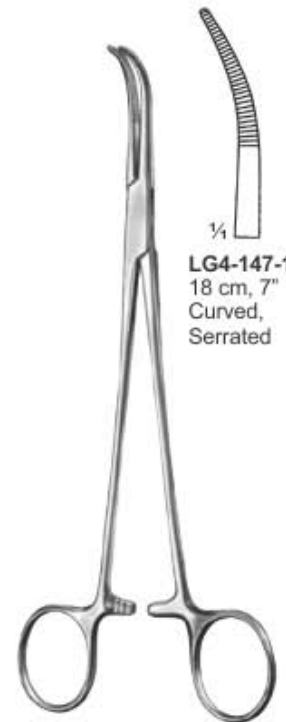

LG4-147-180
18 cm, 7"
Curved,
Serrated

SCHNIDT / SAWTELL



HAEMOSTATIC FORCEPS

Arterienklemmen
Pinzas hemostaticas

Pinces hemostatiques
Pinze emostatiche

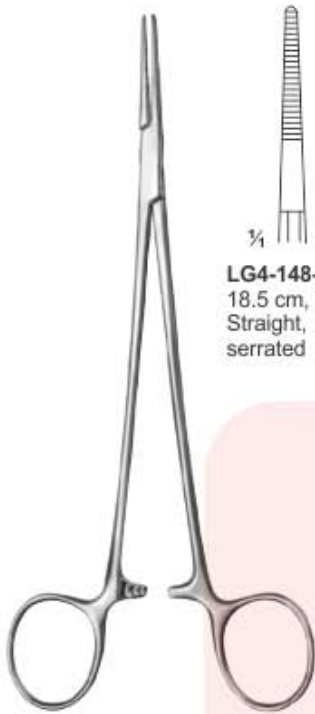

LG4-148-185
18.5 cm, 7 1/4"
Straight,
serrated

ADSON



LG4-149-185
18.5 cm, 7 1/4"
curved,
serrated



LG4-150-185
18.5 cm, 7 1/4"

ADSON 1:2



LG4-151-185
18.5 cm, 7 1/4"



GEMINI
Curved, Serrated

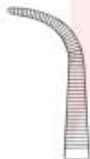

LG4-152-130 13 cm, 5"

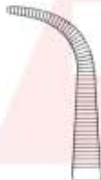

LG4-153-160 16 cm, 6 1/4"



LG4-154-180 18 cm, 7"

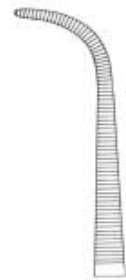

LG4-155-200 20 cm, 8"

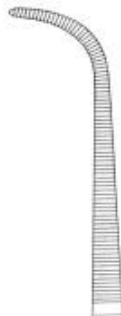

LG4-156-230 23 cm, 9"

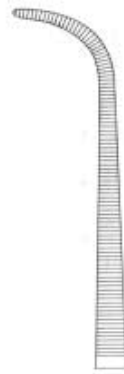

LG4-157-250 25 cm, 10"



LG4-158-280 28 cm, 11"



HAEMOSTATIC FORCEPS

Arterienklemmen
Pinzas hemostaticas

Pinces hemostatiques
Pinze emostatiche



OVERHOLT-GEISSENDOERFER



LG4-159-210
21 cm, 8 1/4"
LG4-160-270
27 cm, 10 3/4"



LG4-161-210
21 cm, 8 1/4"
LG4-162-270
27 cm, 10 3/4"



LG4-163-210
21 cm, 8 1/4"
LG4-164-270
27 cm, 10 3/4"

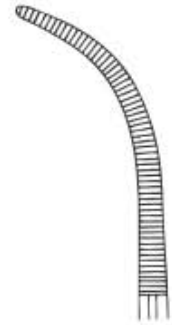

LG4-165-210
21 cm, 8 1/4"
LG4-166-270
27 cm, 10 3/4"



LG4-167-210
21 cm, 8 1/4"
LG4-168-270
27 cm, 10 3/4"



LG4-169-210
21 cm, 8 1/4"
LG4-170-270
27 cm, 10 3/4"



LG4-171-210
21 cm, 8 1/4"
LG4-172-270
27 cm, 10 3/4"

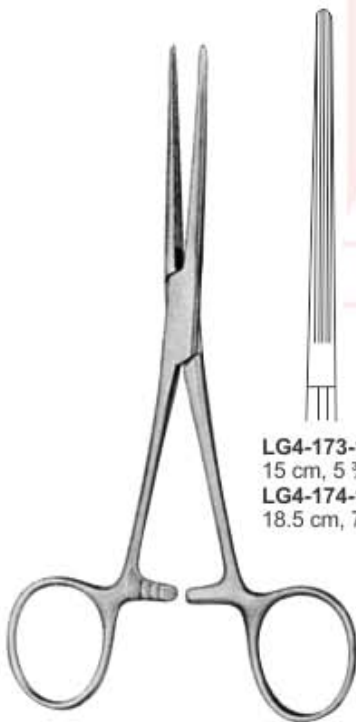

BAINBRIDGE



LG4-173-150
15 cm, 5 3/4"
LG4-174-185
18.5 cm, 7 1/4"



LG4-175-150
15 cm, 5 3/4"
LG4-176-185
18.5 cm, 7 1/4"

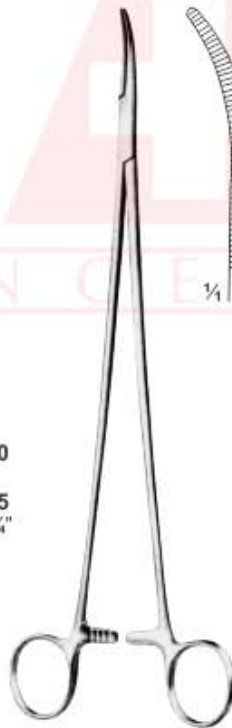

BRIDGE
LG4-177-280
28 cm, 11"
Curved, Serrated



LAWRENCE
LG4-178-280
28.0 cm, 11"



KANTROWITZ
LG4-179-200 20 cm, 8"
LG4-180-240 24 cm, 9 1/2"
LG4-181-280 28 cm, 11"
Right Angle, Serrated

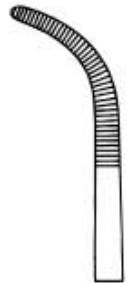



HAEMOSTATIC FORCEPS

Arterienklemmen
Pinzas hemostaticas

Pinces hemostatiques
Pinze emostatiche



RUMEL
23.0 cm, 9"



LG4-182-230
23.0 cm, 9"



LG4-183-230
23.0 cm, 9"

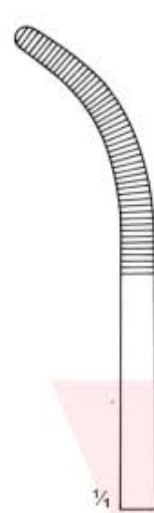

LG4-184-230
23.0 cm, 9"



LG4-185-230
23.0 cm, 9"

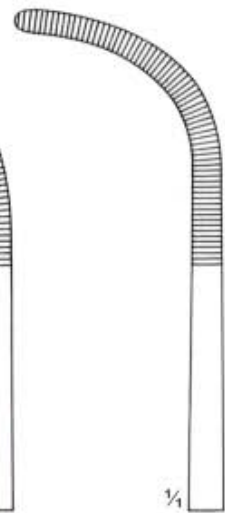

LG4-186-230
23.0 cm, 9"



TOENNIS



LG4-187-210
21 cm, 8 1/4"
LG4-188-260
26 cm, 10 1/4"



LG4-189-210
21 cm, 8 1/4"
LG4-190-260
26 cm, 10 1/4"



TOENNIS 1:2



LG4-191-210
21 cm, 8 1/4"
LG4-192-260
26 cm, 10 1/4"



LG4-193-210
21 cm, 8 1/4"
LG4-194-260
26 cm, 10 1/4"



HAEMOSTATIC FORCEPS

Arterienklemmen
Pinzas hemostaticas

Pinces hemostatiques
Pinze emostatiche



CRAFOORD-SELLORS

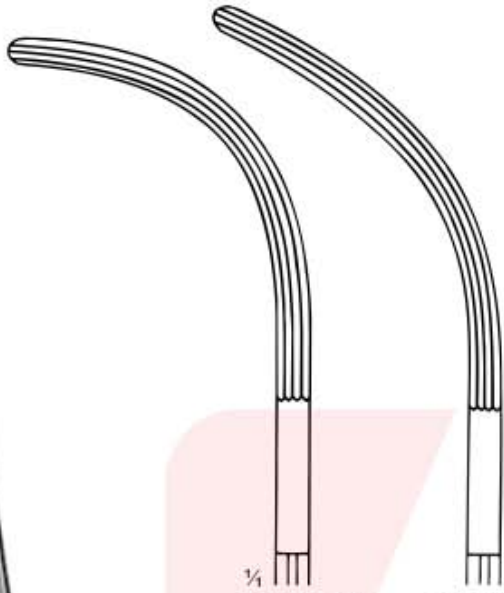

LG4-195-220
22.0 cm, 8 3/4"

LG4-196-230
23.0 cm, 9"

LG4-197-240
24.0 cm, 9 1/2"

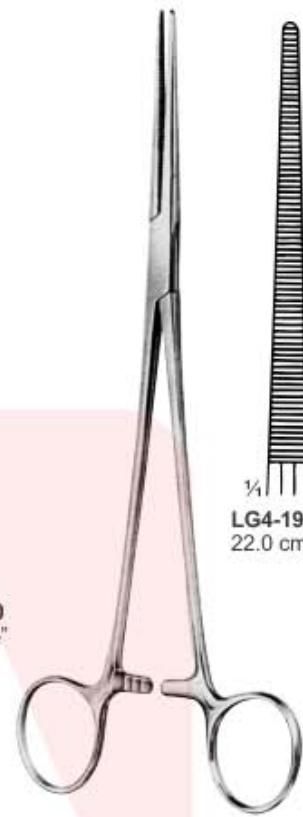

ROBERTS



LG4-198-220
22.0 cm, 8 3/4"

LG4-199-220
22.0 cm, 8 3/4"



HEISS
20.0 cm, 8"

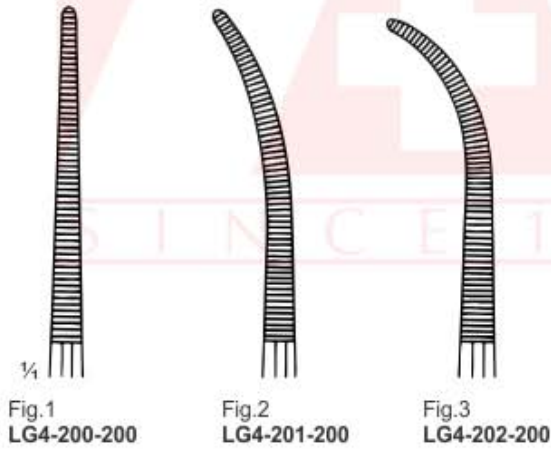

Fig.1
LG4-200-200

Fig.2
LG4-201-200

Fig.3
LG4-202-200



BENGOLEA

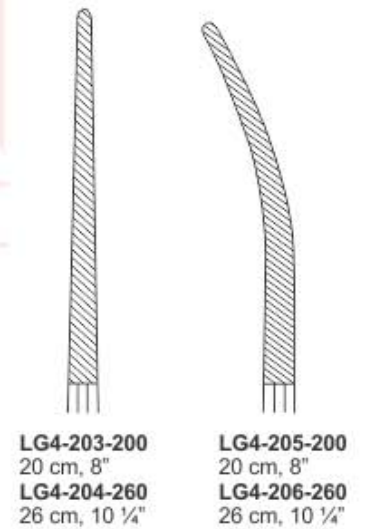

LG4-203-200
20 cm, 8"
LG4-204-260
26 cm, 10 1/4"

LG4-205-200
20 cm, 8"
LG4-206-260
26 cm, 10 1/4"



HAEMOSTATIC FORCEPS

Arterienklemmen
Pinzas hemostaticas

Pinces hemostatiques
Pinze emostatiche



LG4-207-140
14 cm, 5 1/2"
Curved,
Serrated

BABY-MIXTER

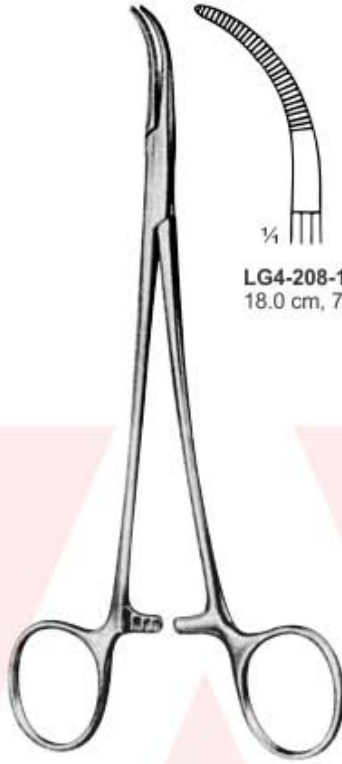

LG4-208-180
18.0 cm, 7"

BABY-MIXTER



LG4-209-220
22.0 cm, 8 1/2"

MIXTER



LG4-210-220
22 cm, 8 1/4"

MIXTER
Right Angle
Grooves

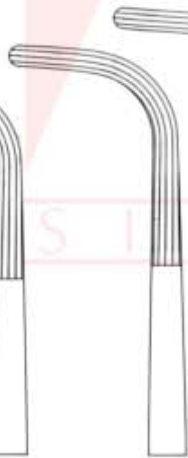

LG4-211-250
25 cm, 10"



LG4-212-280
28 cm, 11"



LG4-213-155
15.5 cm, 6"
Fully Curved,
Serrated

MIXTER



LG4-214-190
19 cm, 7 1/2"
Fully Curved,
Serrated



LG4-215-230
23 cm, 9"
Fully Curved,
Serrated



HAEMOSTATIC FORCEPS

Arterienklemmen
Pinzas hemostaticas

Pinces hemostatiques
Pinze emostatiche



DEAN-SHALLCROSS



1/4
LG4-216-180
18 cm, 7"
S Curve,
Coarse
serration

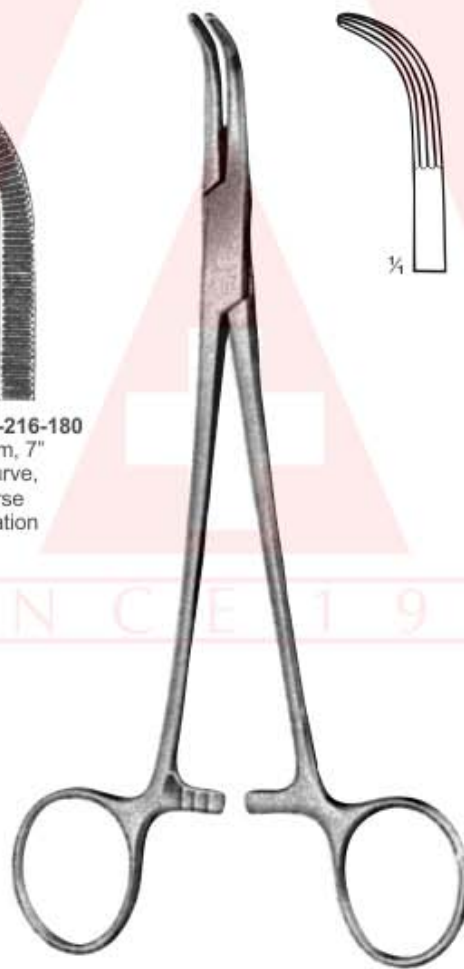

LOWER
LG4-217-180
18.0 cm, 7"

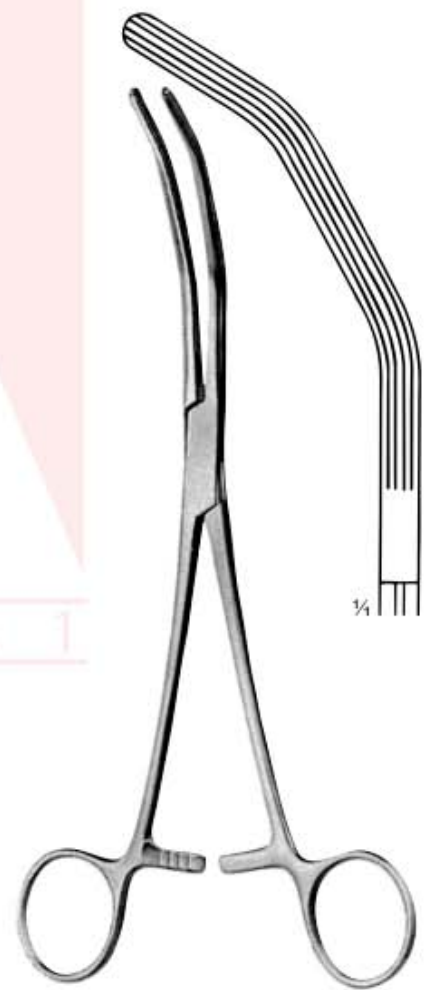

HERRICK
LG4-218-230
23.0 cm, 9"

1/4

S I N C E 1 9 8 1



HAEMOSTATIC FORCEPS

Arterienklemmen
Pinzas hemostaticas

Pinces hemostatiques
Pinze emostatiche

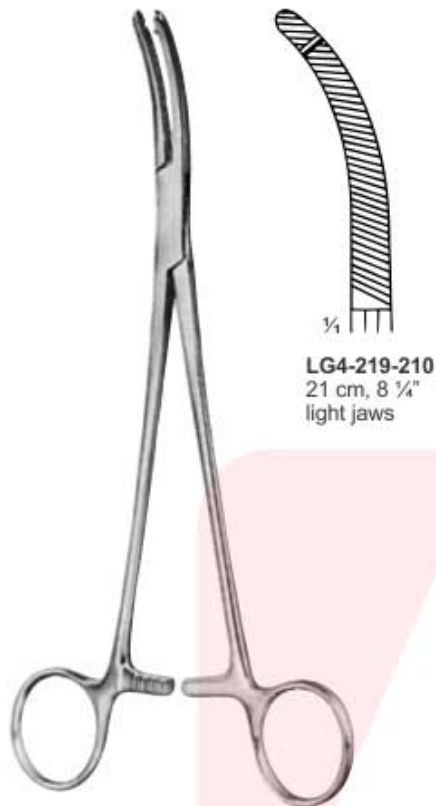

LG4-219-210
21 cm, 8 1/4"
light jaws

HEANEY

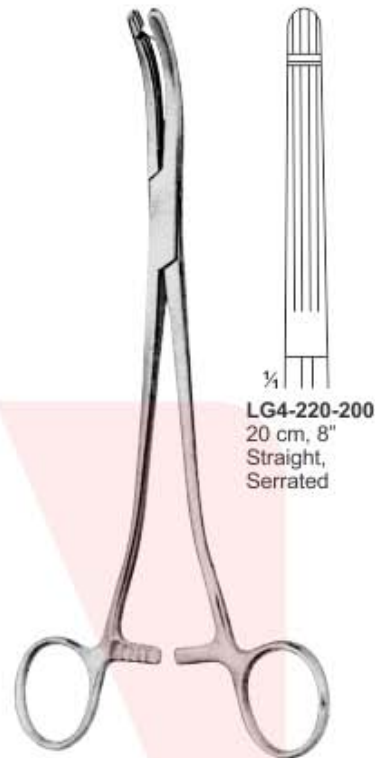

LG4-220-200
20 cm, 8"
Straight,
Serrated

HEANEY / BALLANTINE



LG4-221-200
20 cm, 8"
Slight Curve,
Serrated

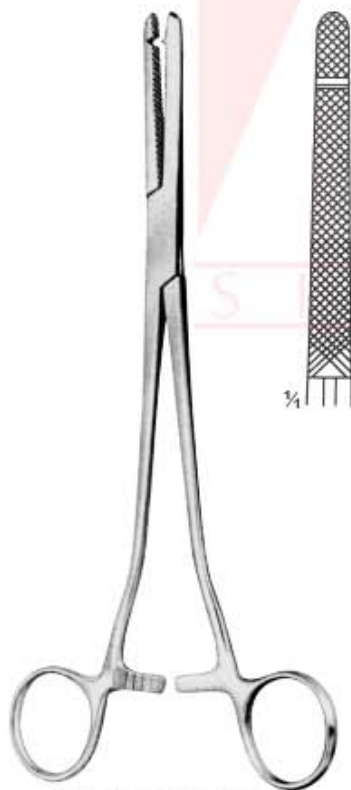

HEANEY / REZAK
LG4-222-210 21 cm, 8 1/4"
Straight, Cross Serrated

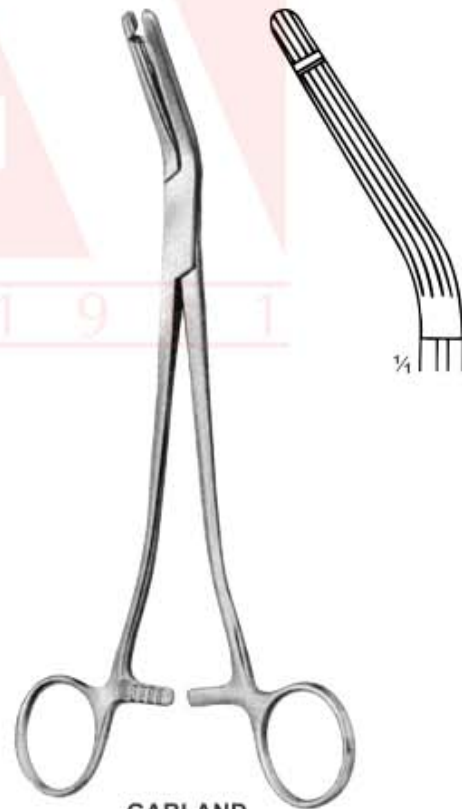

GARLAND
LG4-223-210
21 cm, 8 1/4"



HAEMOSTATIC FORCEPS

Arterienklemmen
Pinzas hemostaticas

Pinces hemostatiques
Pinze emostatiche



HEANEY



LG4-224-195
19.5 cm, 7 1/2"



LG4-225-215
21.5 cm, 8 1/2"



LG4-226-240
24 cm, 9 1/2"



LG4-227-195
19.5 cm, 7 1/2"



LG4-228-215
21.5 cm, 8 1/2"



LG4-229-240
24 cm, 9 1/2"

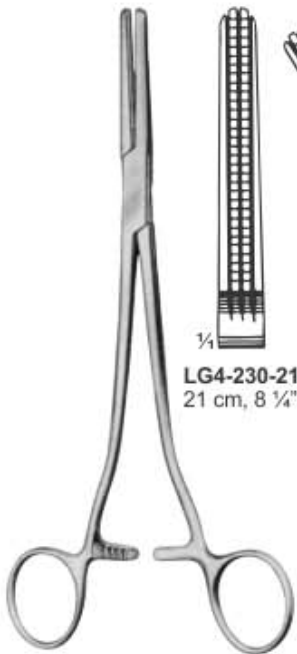

PARAMETRIUM

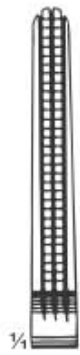

LG4-230-210
21 cm, 8 1/4"



LG4-231-210
21 cm, 8 1/4"



LG4-232-210
21 cm, 8 1/4"



LG4-233-210
21 cm, 8 1/4"

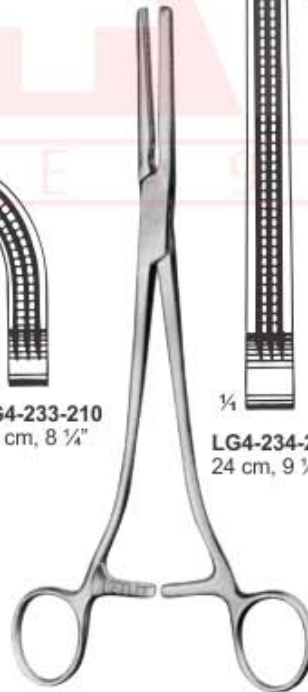

PARAMETRIUM

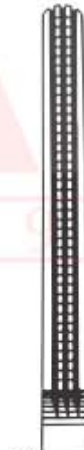

LG4-234-240
24 cm, 9 1/2"



LG4-235-240
24 cm, 9 1/2"



LG4-236-240
24 cm, 9 1/2"

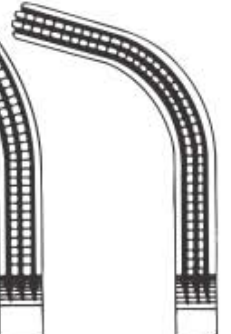

LG4-237-240
24 cm, 9 1/2"



HAEMOSTATIC FORCEPS

Arterienklemmen
Pinzas hemostaticas

Pinces hemostatiques
Pinze emostatiche



GUYON

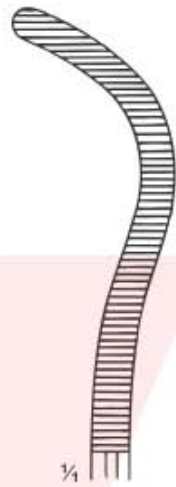

LG4-238-200 20 cm, 8"



LG4-239-220 22 cm, 8 1/2"

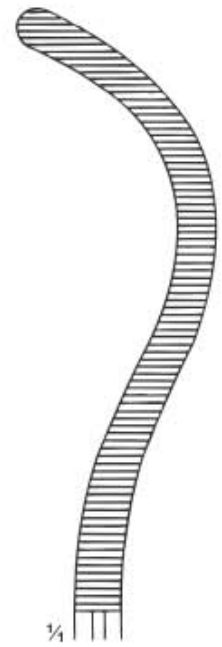

LG4-240-240 24 cm, 9 1/2"



GUYON



LG4-241-230
23 cm, 9"



LG4-242-240
24 cm, 9 1/2"



GUYON

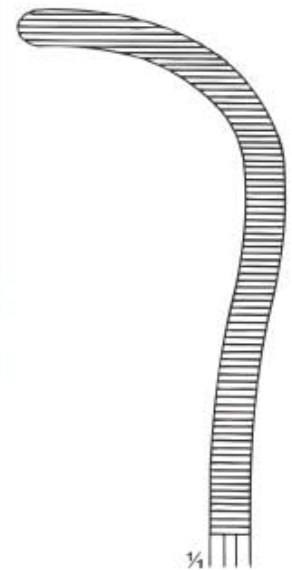

LG4-243-230
23 cm, 9"



HAEMOSTATIC FORCEPS

Arterienklemmen
Pinzas hemostaticas

Pinces hemostatiques
Pinze emostatiche



MOYNIHAN ARTERY
FORCEPS



LG4-244-230
23.0 cm, 9"



LG4-245-240
24.0 cm, 9 1/4"

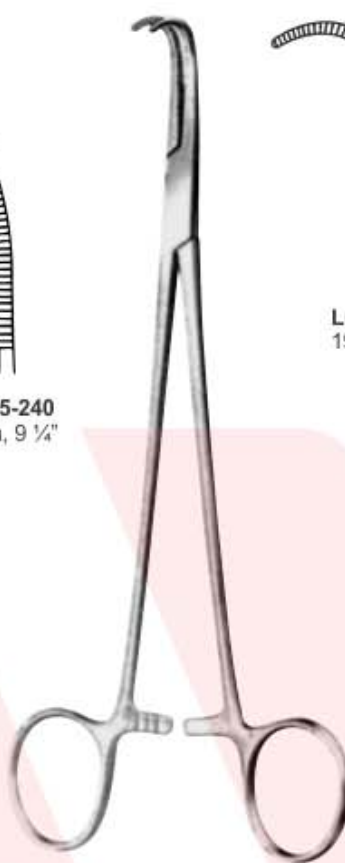

NEGUS

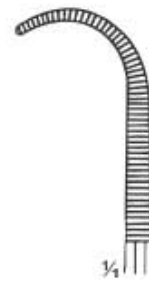

LG4-246-190
19 cm, 7 1/2"



LG4-247-190
19 cm, 7 1/2"



FAURE 1:2



LG4-248-200
20 cm, 8"
Slightly
Curved



LG4-249-200
20 cm, 8"
More
Curved



SCHINDLER 1:2



LG4-250-200
20 cm, 8"



HAEMOSTATIC FORCEPS

Arterienklemmen
Pinzas hemostaticas

Pinces hemostatiques
Pinze emostatiche

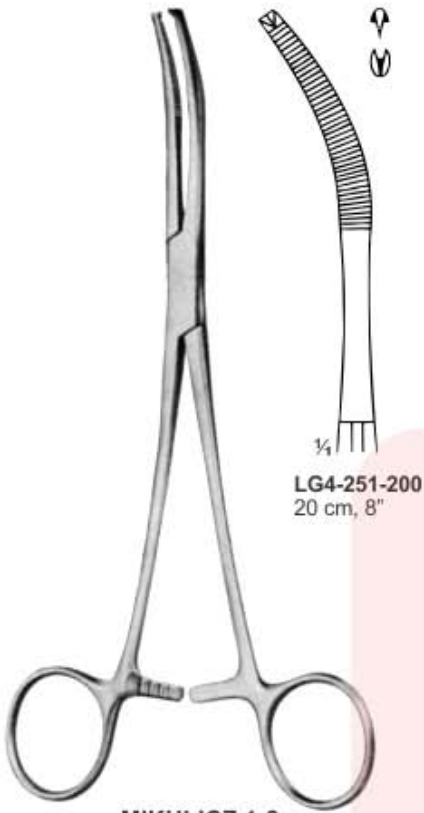

LG4-251-200
20 cm, 8"

MIKULICZ 1:2

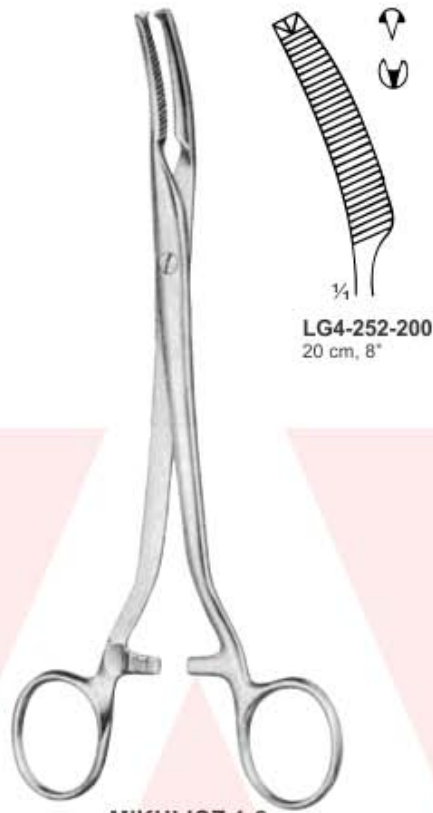

LG4-252-200
20 cm, 8"

MIKULICZ 1:2

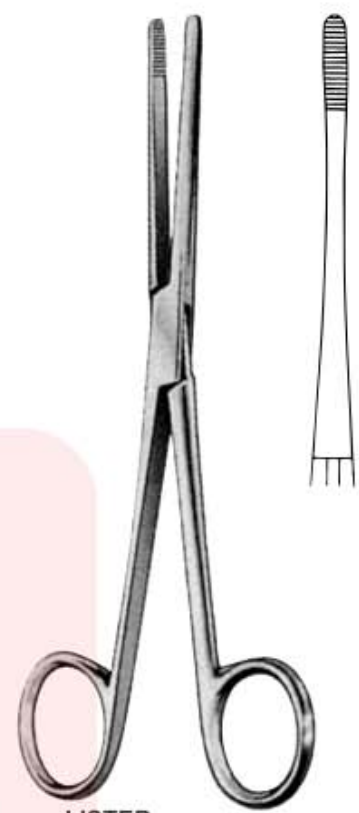

LISTER
LG4-253-130 13 cm, 5"
LG4-254-160 16 cm, 6 1/4"
LG4-255-180 18 cm, 7"



LG4-256-260
26 cm, 10 1/4"
Curved,
Serrated

BOZEMANN

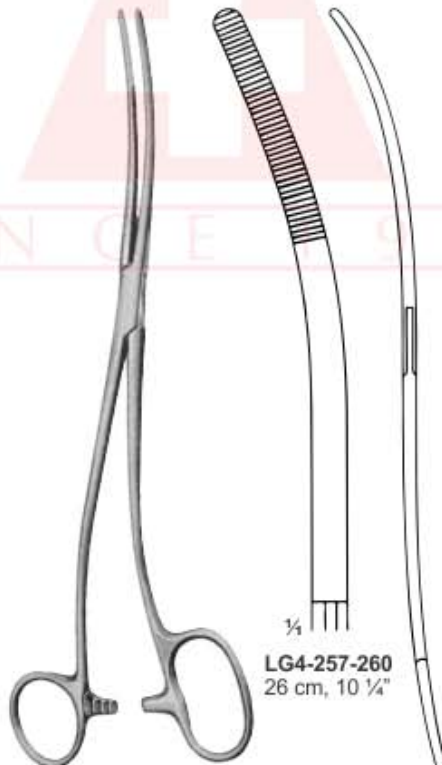

LG4-257-260
26 cm, 10 1/4"

BOZEMANN-DOUGLAS



LG4-258-260
26 cm, 10 1/4"

BOZEMANN



TOWEL FORCEPS

Tuchklemmen
Pinzas de campo

Pinces à champs
Pinze fissatele



**JONES /
PERFORATING**
LG4-259-090
9 cm, 3 1/2"
Slight Curve



ENGL. MODELL
LG4-260-090
9 cm, 3 1/2"

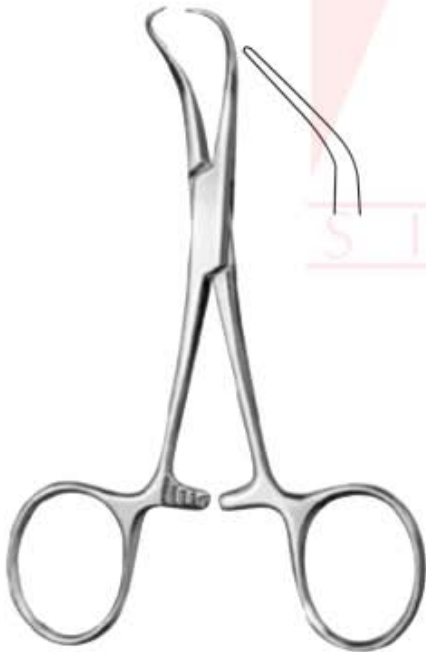

BACKHAUS
LG4-261-080 8 cm, 3"
LG4-262-110 11 cm, 4 1/2"
LG4-263-130 13 cm, 5"
LG4-264-150 15 cm, 5 3/4"
Curved



ROEDER
LG4-265-130 13 cm, 5"
LG4-266-150 15 cm, 6"
Curved, Serrated

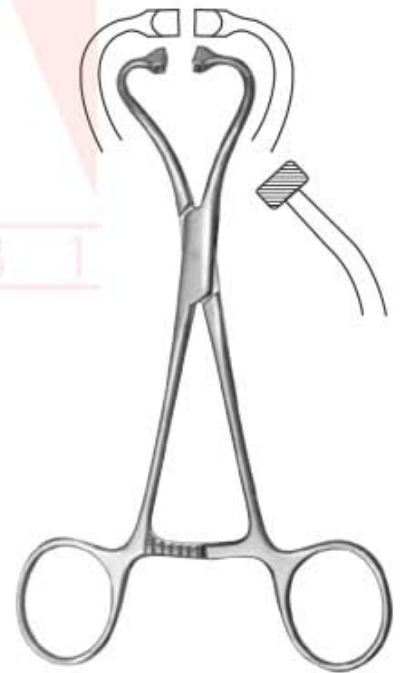

NON-PERFORATING
LG4-267-110 11 cm, 4 1/2"
LG4-268-130 13 cm, 5"



TOWEL FORCEPS

Tuchklemmen
Pinzas de campo

Pinces à champs
Pinze fissatele

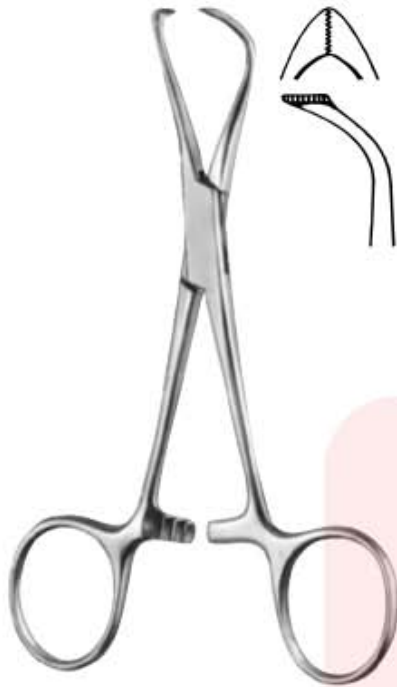

LORNA
LG4-269-100 10 cm, 4"
LG4-270-110 11 cm, 4 1/2"
LG4-271-130 13 cm, 5"



BACKHAUS CLIP
LG4-272-110 11 cm, 4 1/2"
with clip for tubing or
cable



BALL & SOCKET
LG4-273-130 13 cm, 5"
Non-perforating



TOHOKU
LG4-274-100 10 cm, 4"
LG4-275-130 13 cm, 5"
Non-perforating



PEERS-BERTMAN
LG4-276-145
14.5 cm, 5 3/4"
Serrated

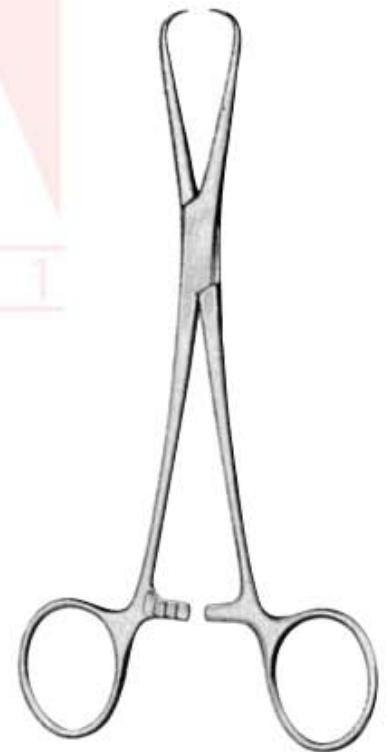

BERNHARD
LG4-277-165
16.5 cm, 6 1/2"



SPONGE FORCEPS

Schwammzange
Pinza para tapones

Pince pour éponges
Pinza per tamponi e sponge



FOERSTER-BALLENGER



LG4-278-170
17.75 cm, 6 3/4"
Straight, serrated



LG4-279-200
20.0 cm, 8"
Straight, serrated



LG4-280-200
20.0 cm, 8"
Straight, serrated



LG4-281-255
25.5 cm, 10"
Straight, Smooth



LG4-282-200
20.0 cm, 8"
Curved, serrated



LG4-283-255
25.5 cm, 10"
Curved, serrated

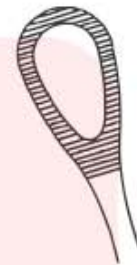

LG4-284-170
17.75 cm, 6 3/4"
Curved, serrated



LG4-285-255
25.5 cm, 10"
Curved, Smooth



HEYWOOD-SMITH

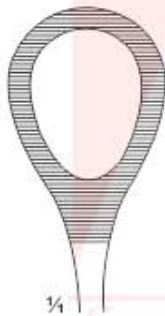

LG4-286-210
21 cm, 8 1/4"
Spread,
serrated

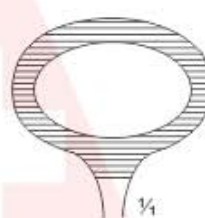

LG4-287-160
16 cm, 6 1/4"



COLLIN



HEYWOOD-SMITH

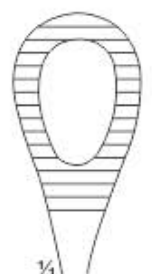

LG4-288-250
25 cm, 10"



SPONGE FORCEPS

Schwammzange
Pinza para tapones

Pince pour éponges
Pinza per tamponi e sponge



GROSS-MAIER

LG4-289-160 16 cm, 6 1/4"
LG4-290-180 18 cm, 7"
LG4-291-200 20 cm, 8"
LG4-292-250 25 cm, 10"
LG4-293-270 27 cm, 11"

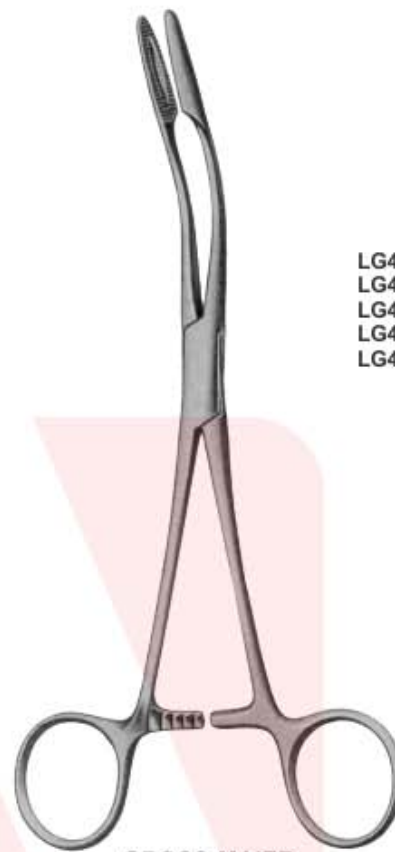

GROSS-MAIER

LG4-294-160 16 cm, 6 1/4"
LG4-295-180 18 cm, 7"
LG4-296-200 20 cm, 8"
LG4-297-250 25 cm, 10"
LG4-298-270 27 cm, 11"



HEYWOOD SMITH
LG4-299-250
25 cm, 10"



RAMPLEY



LG4-300-180
18 cm, 8"



LG4-301-250
25 cm, 10"

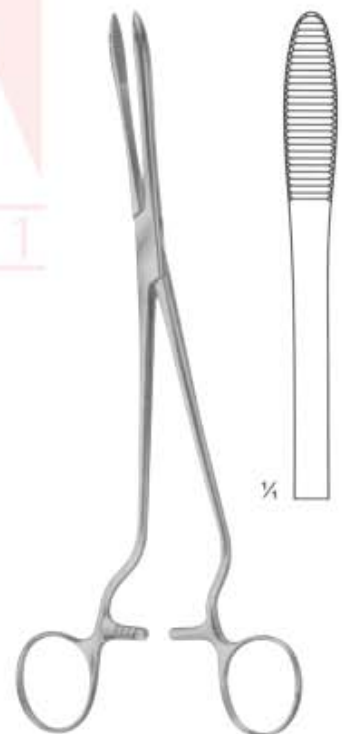

CHERON FORCEPS
LG4-302-250
25 cm, 10"



TUBING CLAMP & SPONGE FORCEPS

Schlauchklemmen, Schwammzange
Pinzas para tubos, Pinza para tapones

Pinces presse-Tubes, Pince pour éponges
Pinze serratubi, Pinza per tamponi e spunge

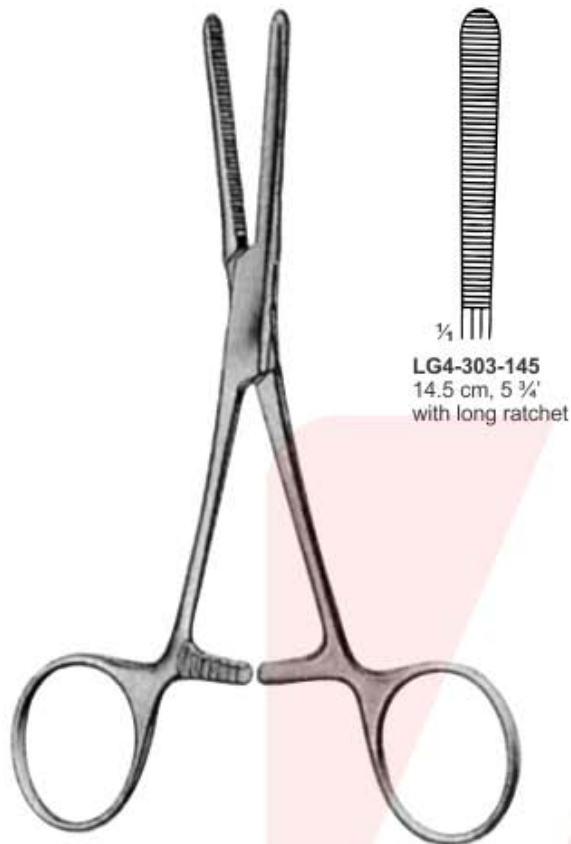

LG4-303-145
14.5 cm, 5 3/4"
with long ratchet

KLINIKUM BERLIN

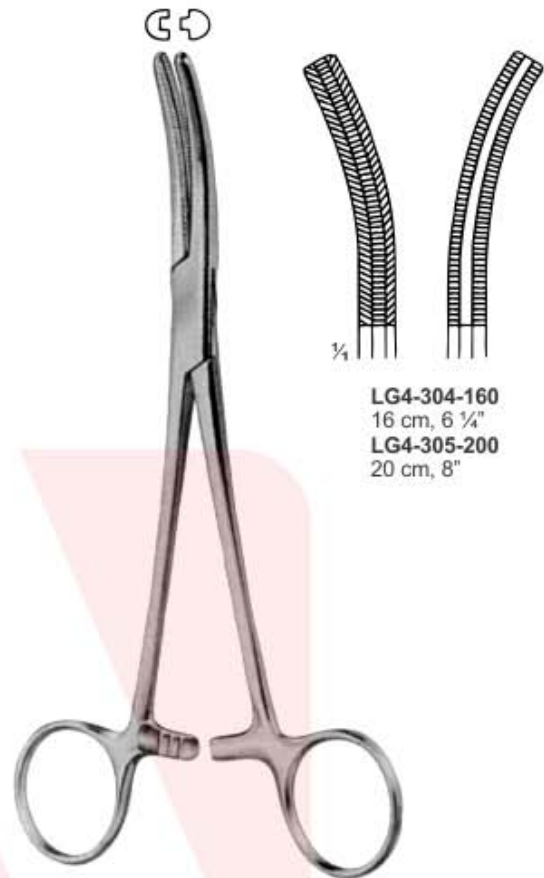

LG4-304-160
16 cm, 6 1/4"
LG4-305-200
20 cm, 8"

FERGUSON



KELLY



LG4-306-320
32 cm, 12 1/2"



FOERSTER-BALLENGER

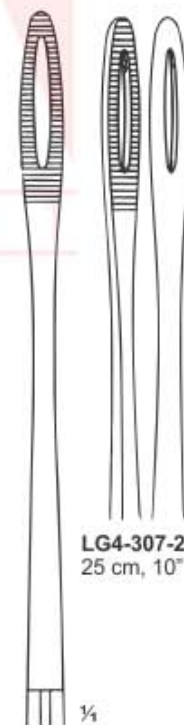

LG4-307-250
25 cm, 10"



LG4-308-250
25 cm, 10"



DRESSING & TISSUE FORCEPS

- DRESSING FORCEPS
- MICRO FORCEPS
- CILIA FORCEPS
- TISSUE FORCEPS
- SPLINTER FORCEPS

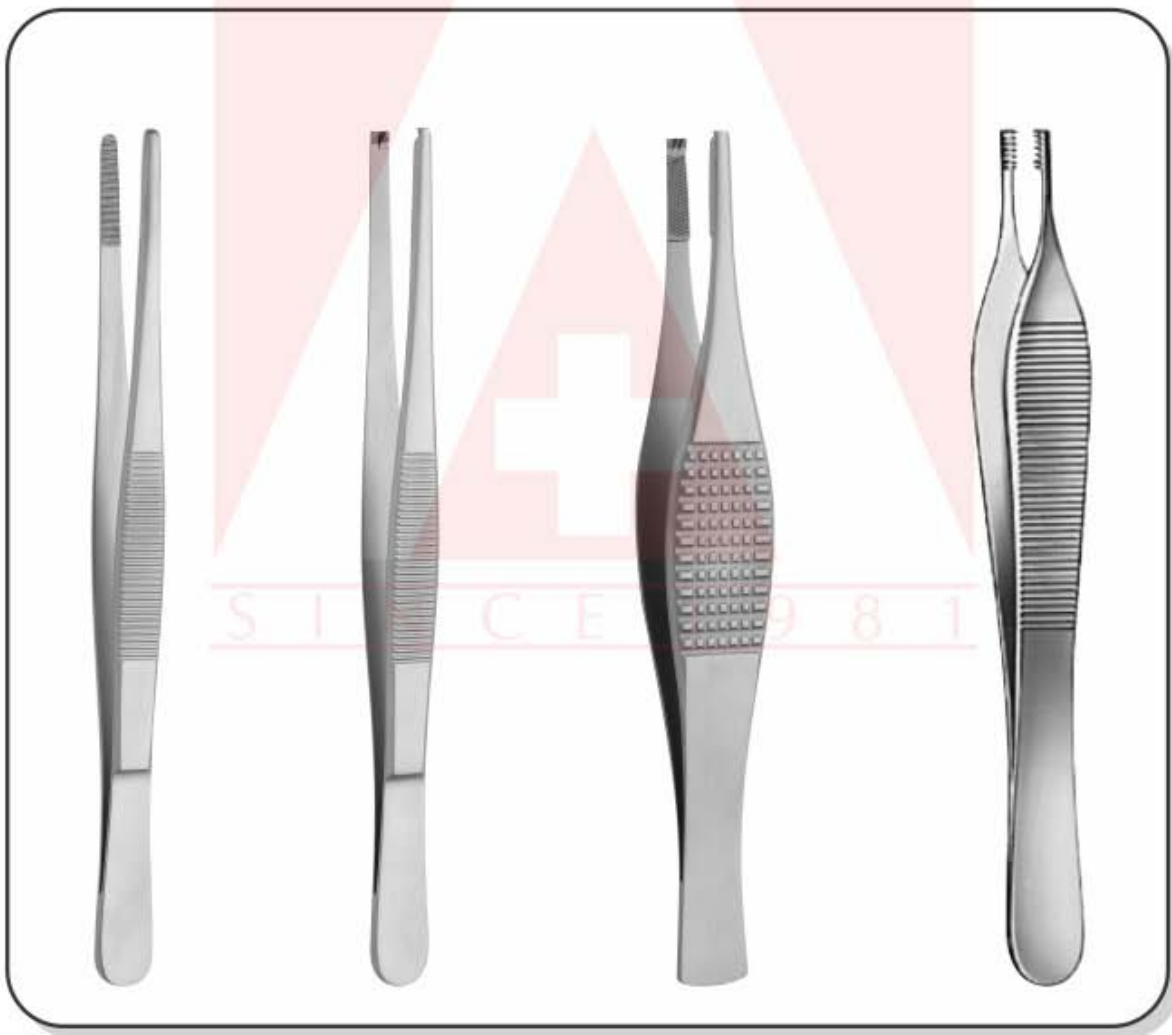



TISSUE & DRESSING FORCEPS

Pinces a tissu, Anatomische pinzetten
Gewebe, Pinzas de disección

Pinzas para tejidos, Pinces à dissection
Pinze per tessuti, Pinze per dissezione



STANDARD



1:2
STANDARD

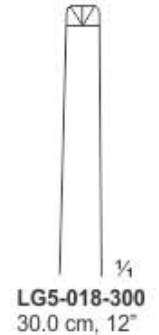
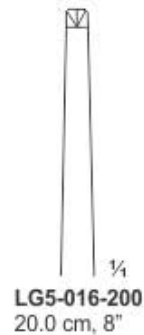
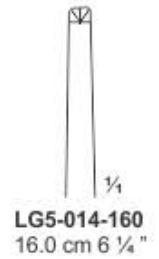
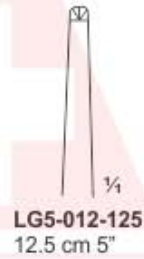
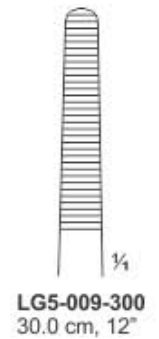
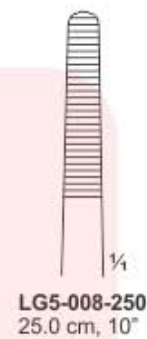
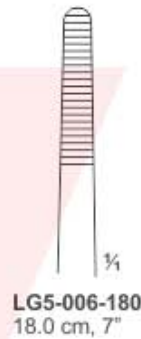
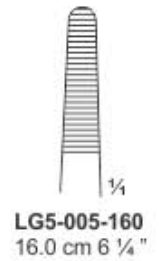
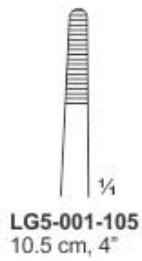

SINCE 1981



DRESSING FORCEPS

Anatomische pinzetten

Pinzas de disección

Pinces à dissection

Pinze per dissezione



STANDARD STRAIGHT
 LG5-019-115 11.5 cm, 4.5"
 LG5-020-130 13.0 cm, 5"
 LG5-021-145 14.5 cm, 5.5"
 LG5-022-160 16.0 cm, 6"
 LG5-023-180 18.0 cm, 7"
 LG5-024-200 20.0 cm, 8"
 LG5-025-250 25.0 cm, 10"
 LG5-026-300 30.0 cm, 11.5"



STANDARD CURVED
 LG5-027-115 11.5 cm, 4.5"
 LG5-028-130 13.0 cm, 5"
 LG5-029-145 14.5 cm, 5.5"
 LG5-030-160 16.0 cm, 6"
 LG5-031-180 18.0 cm, 7"
 LG5-032-200 20.0 cm, 8"



STANDARD
 wide pattern cross serration
 LG5-033-130 13.0 cm, 5"
 LG5-034-145 14.5 cm, 5.5"
 LG5-035-180 18.0 cm, 7"



STANDARD NARROW
 LG5-036-130 13.0 cm, 5"
 LG5-037-145 14.5 cm, 5 1/2"



Mod. USA

STANDARD
 LG5-038-120 12.0 cm, 4.5"
 LG5-039-130 13.0 cm, 5"
 LG5-040-145 14.5 cm, 5.5"
 LG5-041-155 15.5 cm, 6"
 LG5-042-180 18.0 cm, 7"
 LG5-043-210 21.0 cm, 8"
 LG5-044-250 25.0 cm, 10"
 LG5-045-310 31.0 cm, 12"



Mod. USA

STANDARD
 LG5-046-120 12.0 cm, 4.5"
 LG5-047-130 13.0 cm, 5"
 LG5-048-145 14.5 cm, 5.5"
 LG5-049-155 15.5 cm, 6"
 LG5-050-180 18.0 cm, 7"
 LG5-051-210 21.0 cm, 8"
 LG5-052-250 25.0 cm, 10"
 LG5-053-310 31.0 cm, 12"



STILLE
 LG5-054-150
 15.0 cm, 6"



MOD. MARTIN
 LG5-055-130 13.0 cm, 5"
 LG5-056-145 14.5 cm, 5.5"



TISSUE & DRESSING FORCEPS

*Pinces a tissu, Anatomische pinzetten
Gewebe, Pinzas de disección*

*Pinzas para tejidos, Pinces à dissection
Pinze per tessuti, Pinze per dissezione*



¼

SEMKEN

LG5-057-125 12.5 cm, 5" LG5-059-125 12.5 cm, 5"
LG5-058-155 15.5 cm, 6" LG5-060-155 15.5 cm, 6"



¼

SEMKEN

LG5-057-125 12.5 cm, 5" LG5-059-125 12.5 cm, 5"
LG5-058-155 15.5 cm, 6" LG5-060-155 15.5 cm, 6"



¼

TAYLOR

LG5-061-175
17.5 cm 7"



¼

TAYLOR

LG5-062-175
17.5 cm 7"



¼

TAYLOR

LG5-063-175
17.5 cm 7"



¼

TAYLOR

LG5-064-175
17.5 cm 7"



POOTS-SMITH

LG5-065-180 18 cm, 7"
LG5-066-210 21 cm, 8.5"
LG5-067-250 25 cm, 10"



¼

POOTS-SMITH

LG5-068-180 18 cm, 7"
LG5-069-210 21 cm, 8.5"
LG5-070-250 25 cm, 10"



BROPHY

LG5-071-200
20 cm, 8"



¼

BROPHY

LG5-072-200
20 cm, 8"



¼

WANGENSTEEN

LG5-073-230
23 cm, 9"



↔

GERALD 1 : 2

LG5-074-170
17 cm, 6.75"



↔

GERALD 1 : 2

LG5-075-170
17 cm, 6.75"



TISSUE & DRESSING FORCEPS

Pinces a tissu, Anatomische pinzetten
Gewebe, Pinzas de disección

Pinzas para tejidos, Pinces à dissection
Pinze per tessuti, Pinze per dissezione



CUSHING 1:2
LG5-076-175
17.5 cm, 7"



CUSHING 1:2
LG5-077-175
17.5 cm, 7"



POTTS-SMITH 1:2
LG5-078-180 18 cm, 7"
LG5-079-210 21 cm, 8"
LG5-080-250 25 cm, 10"



POTTS-SMITH 1:2
LG5-081-180 18 cm, 7"
LG5-082-210 21 cm, 8"
LG5-083-250 25 cm, 10"



BROPHY 1:2
LG5-084-200
20 cm, 8"

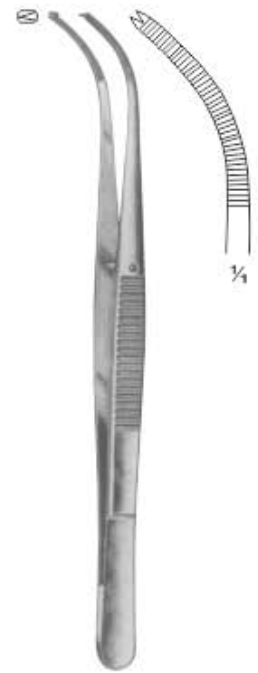

BROPHY 1:2
LG5-085-200
20 cm, 8"



STONE 4:5
LG5-086-150
15 cm, 6"



LERCHE 5:6
LG5-087-150
15 cm, 6"



ADLERKREUTZ 2:3
LG5-088-150 15 cm, 6"
LG5-089-200 20 cm, 8"



ADLERKREUTZ 4:5
LG5-090-150 15 cm, 6"
LG5-091-200 20 cm, 8"



GILLIES 1:2
LG5-092-150
15 cm, 6"



TISSUE FORCEPS

Pinces a tissu,
Gewebe Pinzas

Pinzas para tejidos,
Pinze per tessuti



SEMKEN 1:2
LG5-093-125 12.5 cm, 5"
LG5-094-150 15.0 cm, 6"



SEMKEN 1:2
LG5-095-125 12.5 cm, 5"
LG5-096-150 15.0 cm, 6"



TAYLOR 1:2
LG5-097-175 17.5 cm, 7"



TAYLOR 1:2
LG5-098-175 17.5 cm, 7"



TAYLOR 1:2
LG5-099-175 17.5 cm, 7"



TAYLOR 1:2
LG5-100-175 17.5 cm, 7"



1:2

LG5-101-120 12.0 cm, 4 3/4"
LG5-102-130 13.0 cm, 5"
LG5-103-145 14.5 cm, 5 1/2"
LG5-104-155 15.5 cm, 6"
LG5-105-185 18.5 cm, 7 1/4"
LG5-106-210 21.0 cm, 8 1/4"
LG5-107-250 25.0 cm, 10"
LG5-108-300 30.0 cm, 12 1/4"



2:3

LG5-109-115 11.5 cm, 4 1/2"
LG5-110-130 13.0 cm, 5"
LG5-111-145 14.5 cm, 5 1/2"
LG5-112-160 16.0 cm, 6 1/4"
LG5-113-180 18.0 cm, 7"
LG5-114-200 20.0 cm, 8"
LG5-115-250 25.0 cm, 10"
LG5-116-300 30.0 cm, 12"



MOD. USA 2:3

LG5-117-130 13.0 cm, 5"
LG5-118-145 14.5 cm, 5 1/2"
LG5-119-155 15.5 cm, 6"



3:4

LG5-120-130 13.0 cm, 5"
LG5-121-145 14.5 cm, 5 1/2"
LG5-122-155 15.5 cm, 6"



4:5

LG5-123-130 13.0 cm, 5"
LG5-124-145 14.5 cm, 5 1/2"
LG5-125-155 15.5 cm, 6"



TISSUE FORCEPS

Pinces a tissu,
Gewebe Pinzas

Pinzas para tejidos,
Pinze per tessuti



3:4
LG5-126-130 13 cm, 5"
LG5-127-145 14.5 cm, 5 1/2"
LG5-128-160 16 cm, 6 1/4"

4:5
LG5-129-130 13 cm, 5"
LG5-130-145 14.5 cm, 5 1/2"
LG5-131-160 16 cm, 6 1/4"

1:2
LG5-132-130 13.0 cm, 5"
LG5-133-145 14.5 cm, 5 1/2"
LG5-134-160 16.0 cm, 6 1/4"
LG5-135-200 20.0 cm, 8"

1:2
LG5-136-130 13 cm, 5"
LG5-137-145 14.5 cm, 5 1/2"

1:2
LG5-138-130 13 cm, 5"
LG5-139-145 14.5 cm, 5 1/2"

NELSON
LG5-140-230 23 cm, 9"

FERRIS-SMITH
LG5-141-180 18 cm, 7" 1:2,
LG5-142-180 18 cm, 7" 2:3

1/4
Tissue,
6.7 Teeth

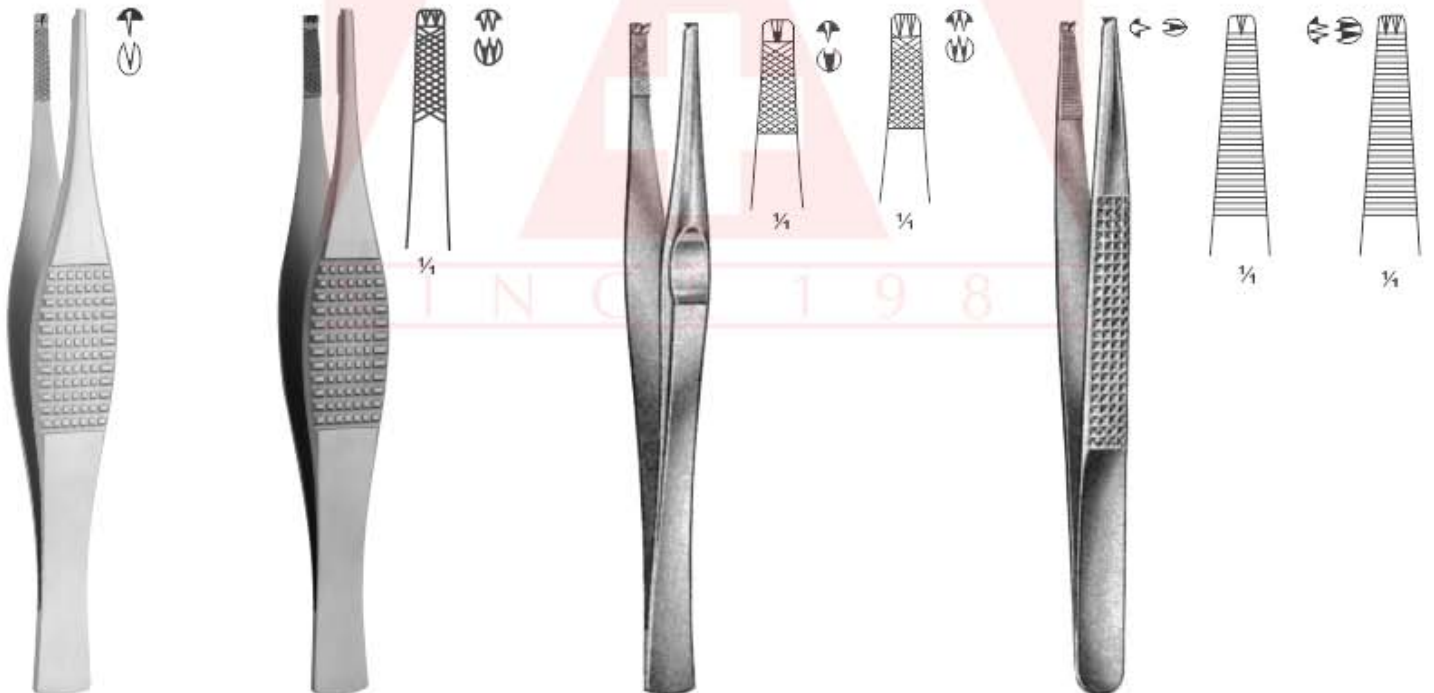

FERRIS-SMITH 1:2
LG5-143-180 18 cm, 7"

FERRIS-SMITH 2:3
LG5-144-180 18 cm, 7"

LANE 1:2, 2:3
LG5-145-125 12.5 cm, 5 1/2"
LG5-146-150 15.0 cm, 6"
LG5-147-170 17.0 cm, 6 3/4"
LG5-148-180 18.0 cm, 7"
LG5-149-200 20.0 cm, 8"

BONNEY
LG5-150-180 18 cm, 7" 1:2
LG5-151-180 18 cm, 7" 2:3



TISSUE & DRESSING FORCEPS

*Pincas a tissu, Anatomische pinzetten
Gewebe, Pinzas de disección*

*Pinzas para tejidos, Pincas à dissection
Pinze per tessuti, Pinze per dissezione*

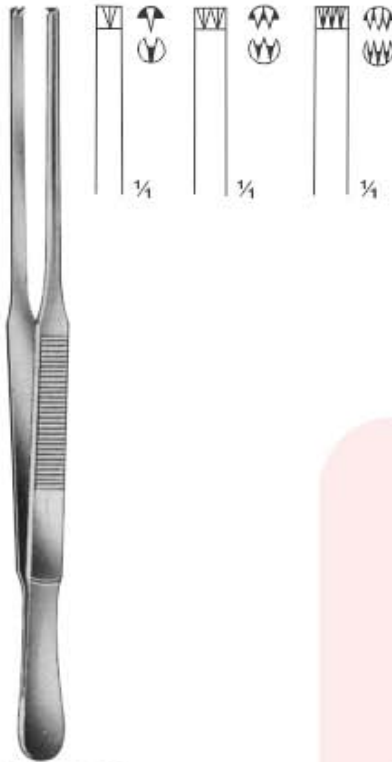

DUEHRSSSEN
 LG5-152-200 20 cm, 8" 1:2
 LG5-153-200 20 cm, 8" 2:3
 LG5-154-200 20 cm, 8" 3:4



DAVIS
 LG5-155-250
 25 cm, 10"



RUSSIAN-MODELL
 LG5-156-150 15 cm, 5 3/4"
 LG5-157-200 20 cm, 8"
 LG5-158-250 25 cm, 10"

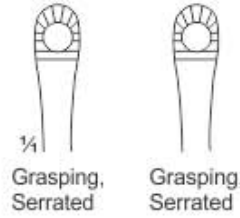

SINGLEY-TUTTLE
 LG5-159-230
 23 cm, 9"



**SINGLEY-TUTTLE
 INTestinal**
 LG5-160-230
 23 cm, 9"



COLLIN-DUVAL



LG5-161-200
 20 cm, 8"

LG5-162-200
 20 cm, 8"

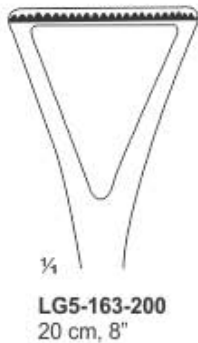

LG5-163-200
 20 cm, 8"



LUCAE / ENT



LG5-164-140
 14 cm, 5 1/2"
 Dressing, Serrated
LG5-165-160
 16 cm, 6 1/2"
 Dressing, Serrated



**JANSEN-
 GRUENWALD**

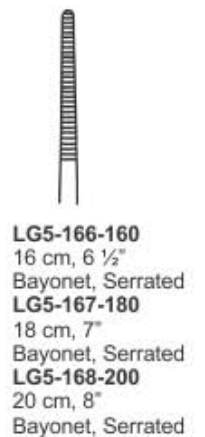

LG5-166-160
 16 cm, 6 1/2"
 Bayonet, Serrated
LG5-167-180
 18 cm, 7"
 Bayonet, Serrated
LG5-168-200
 20 cm, 8"
 Bayonet, Serrated



TISSUE & DRESSING FORCEPS

*Pincas a tissu, Anatomische pinzetten
Gewebe, Pinzas de disección*

*Pinzas para tejidos, Pincas à dissection
Pinze per tessuti, Pinze per dissezione*



**ADSON /
MICRO-ADSON**



LG5-169-120
12 cm, 5"
dressing, serrated



LG5-170-120
12 cm, 5"
dressing,
Micro serrated



LG5-171-120
12 cm, 5"
dressing, serrated
tungsten carbide



EWALD / HUDSON



LG5-175-120
12 cm, 5"
Dressing, Serrated



LG5-172-120
12 cm, 5"
Tissue,
1:2 Teeth



LG5-173-120
12 cm, 5"
Tissue, Micro 1:2 Teeth
LG5-174-120
12 cm, 5"
Tissue, 2:3 Teeth



LG5-176-120
12 cm, 5"
Tissue, 1:2 Teeth



ADSON-BROWN



LG5-177-120
12 cm, 5"
Tissue, 7:7 Teeth

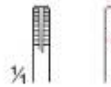

LG5-178-120
12 cm, 5"
Tissue, 9:9 Teeth



ADSON-BROWN
LG5-179-120 12 cm, 5"

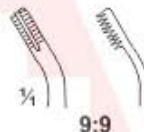

9:9



BROWN



LG5-180-150
15 cm, 6"
Straight, 9:9 Teeth



TISSUE & DRESSING FORCEPS

*Pinces a tissu, Anatomische pinzetten
Gewebe, Pinzas de disección*

*Pinzas para tejidos, Pinces à dissection
Pinze per tessuti, Pinze per dissezione*

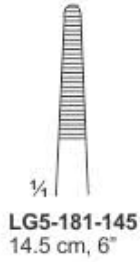

LG5-181-145
14.5 cm, 6"

MODELL USA

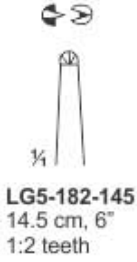

LG5-182-145
14.5 cm, 6"
1:2 teeth

MODELL USA



MCINDOE
LG5-183-150
15 cm, 6"



GILLIES
LG5-184-150
15 cm, 6"
1:2 teeth



LG5-185-120
12 cm, 5"
Dressing,
Micro serrated



LG5-186-120
12 cm, 5"
Tissue,
Micro-1:2 Teeth



LG5-187-120
12 cm, 5"
Tissue, 1:2 Teeth

**LIGHTWEIGHT-
ADSON**



**DE BAKEY /
LIGHTWEIGHT**
LG5-188-160
16 cm, 6 1/2"



LG5-189-160
16 cm, 6 1/2"



LG5-190-160
16 cm, 6 1/2"



LG5-191-160
16 cm, 6 1/2"

DE BAKEY



TISSUE FORCEPS & ATRAUMATIC DRESSING FORCEPS

*Pincas a tissu, Atraumatische Pinzette
Gewebe, Pinza de disección atraumática*

*Pinzas para tejidos, Pince atraumatique à dissection
Pinze per tessuti, Pinza atraumatica*



SAMII
23 cm, 9"
Jaws Spoon-Shaped

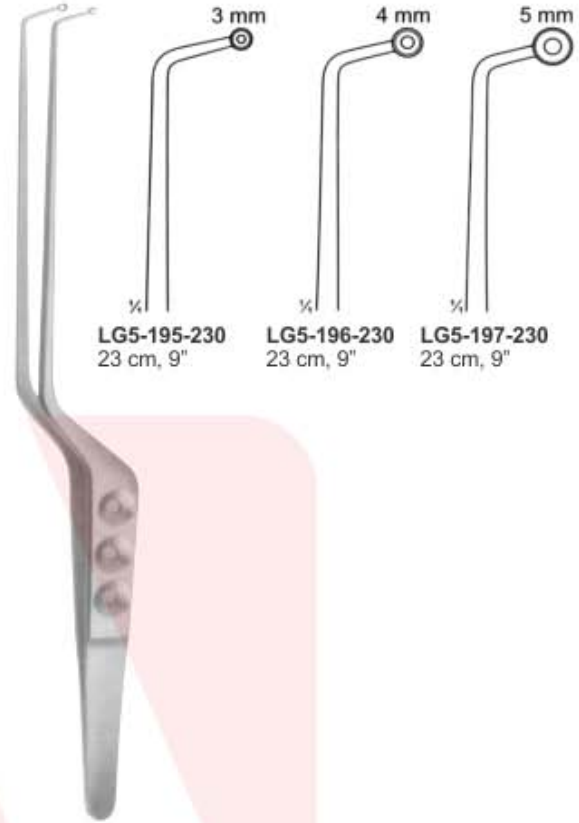

SAMII
23 cm, 9"
Jaws Spoon-Shaped



DEBAKEY

LG5-198-160 16 cm, 6 1/2" 1.5 mm
LG5-199-200 20 cm, 8" 1.5 mm
LG5-200-240 24 cm, 9 1/2" 1.5 mm

LG5-205-160 16 cm, 6 1/2" 2.7mm
LG5-206-200 20 cm, 8" 2.7mm
LG5-207-200 20 cm, 8" 2.7mm Heavy
LG5-208-240 24 cm, 9 1/2" 2.7mm
LG5-209-305 30.5 cm, 12" 2.7mm

LG5-201-160 16 cm, 6 1/2" 2.0mm
LG5-202-200 20 cm, 8" 2.0mm
LG5-203-240 24 cm, 9 1/2" 2.0mm
LG5-204-305 30.5 cm, 12" 2.0mm

LG5-210-160 16.0 cm, 6 1/2" 3.5mm
LG5-211-200 20.0 cm, 8" 3.5mm
LG5-212-240 24.0 cm, 9 1/2" 3.5mm
LG5-213-305 30.5 cm, 12" 3.5mm



DE BAKEY

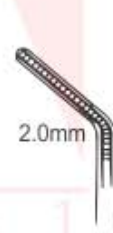

2.0mm
LG5-214-160 16 cm, 6 1/2"

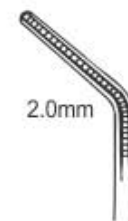

2.0mm
LG5-216-240 24 cm, 9 1/2"



2.0mm
LG5-215-200 20 cm, 8"

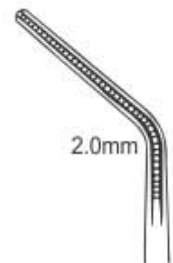

2.0mm
LG5-217-300 30 cm, 12"



MICRO FORCEPS

Mikropinzetten

Micro-Pinzas

Micro-Pinces

Micro-Pinze

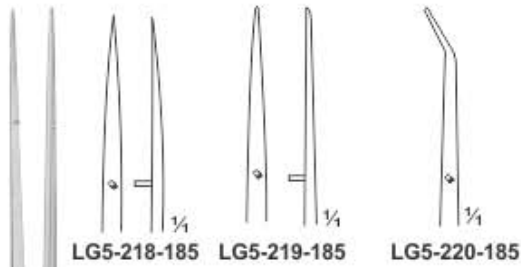

LG5-218-185

LG5-219-185

LG5-220-185

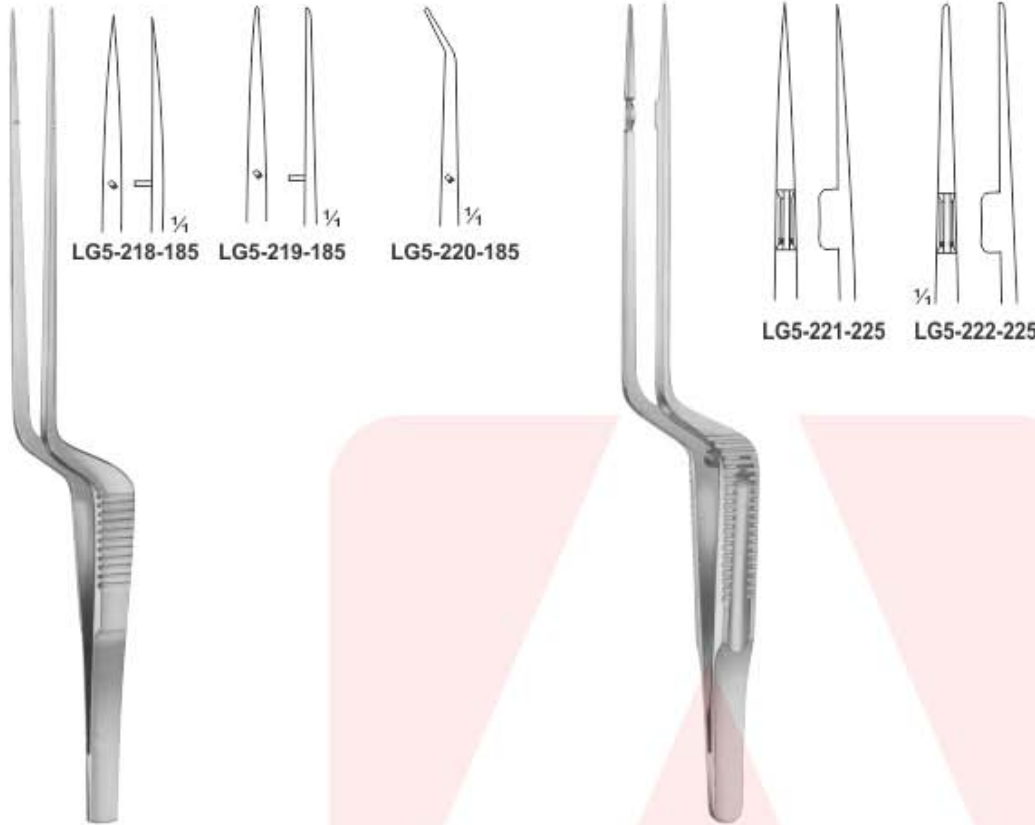

LG5-221-225

LG5-222-225



MICRO FORCEPS
18.5 cm, 7 1/4"

MICRO FORCEPS
22.5 cm, 9"

MICRO FORCEPS
LG5-223-140
14.0 cm, 5 1/2"



MICRO FORCEPS 1:2
LG5-224-140
14.0 cm, 5 1/2"



MICRO FORCEPS 1:2
LG5-225-140
14.0 cm, 5 1/2"



MICRO FORCEPS
LG5-226-140 14.0 cm, 5 1/2"
LG5-227-180 18.0 cm, 7"

Smooth
Jaws

S I N C E 1 9 8



MICRO FORCEPS

Mikropinzetten

Micro-Pinzas

Micro-Pinces

Micro-Pinze

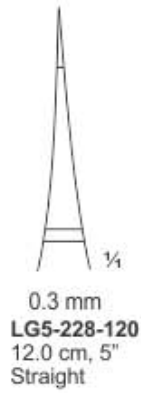

0.3 mm
LG5-228-120
12.0 cm, 5"
Straight

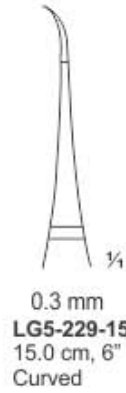

0.3 mm
LG5-229-150
15.0 cm, 6"
Curved



LG5-230-180
Straight



LG5-231-180
Curved

MICRO FORCEPS

MICRO FORCEPS
18.0 cm, 7"



STEVENS
10.5cm, 4"



LG5-232-105
Straight



LG5-233-105
Curved



LG5-234-105
Curved



LG5-235-105
Straight



LG5-236-105
Curved



LG5-237-105
Curved

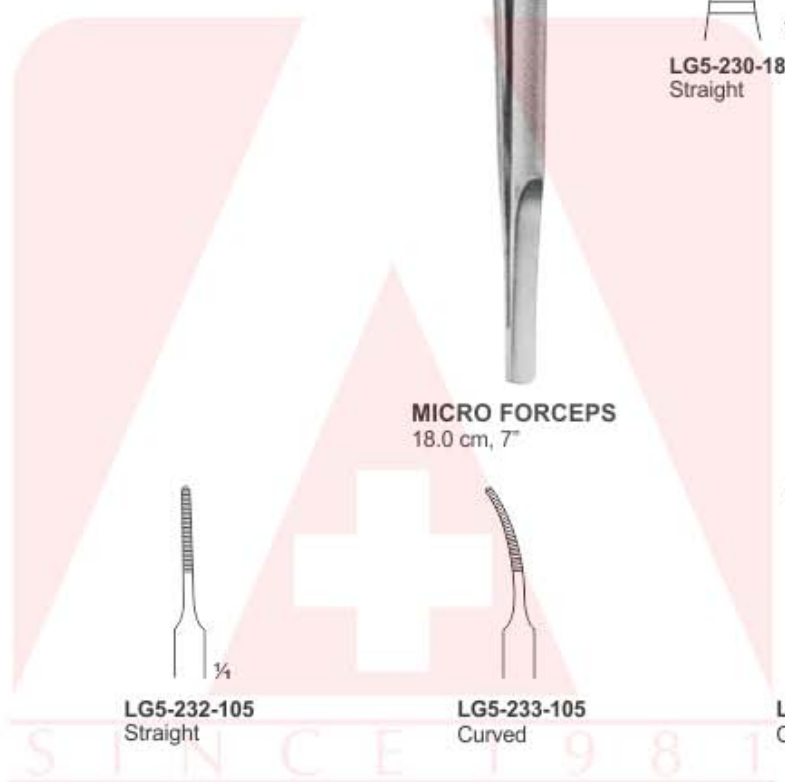



TISSUE & DRESSING FORCEPS

Pincas a tissu, Anatomische pinzetten
Gewebe, Pinzas de disección

Pinzas para tejidos, Pincas à dissection
Pinze per tessuti, Pinze per dissezione



GRAEFE
LG5-238-070 0.5 mm
LG5-239-070 0.7 mm
LG5-240-070 1.0 mm
7.0 cm, 3"



GRAEFE
LG5-241-070 0.5 mm
LG5-242-070 0.7 mm
LG5-243-070 1.0 mm
7.0 cm, 3"



GRAEFE 1:2
LG5-244-070 0.5 mm
LG5-245-070 0.7 mm
LG5-246-070 1.0 mm
7.0 cm, 3"



GRAEFE 1:2
LG5-247-070 0.5 mm
LG5-248-070 0.7 mm
LG5-249-070 1.0 mm
7.0 cm, 3"



GRAEFE



LG5-250-070
7.0 cm, 2 3/4"
LG5-251-100
10.0 cm, 4"



LG5-252-070
7.0 cm, 2 3/4"
LG5-253-100
10.0 cm, 4"



LG5-254-070
7.0 cm, 2 3/4"
LG5-255-100
10.0 cm, 4"



LG5-256-070
7.0 cm, 2 3/4"
LG5-257-100
10.0 cm, 4"



LG5-258-070
7.0 cm, 2 3/4"
LG5-259-100
10.0 cm, 4"



LG5-260-070
7.0 cm, 2 3/4"
LG5-261-100
10.0 cm, 4"



STEVENS 1:2



LG5-262-110
11.0 cm, 4 1/2"



STEVENS 1:2



LG5-263-110
11.0 cm, 4 1/2"



JEWELER TYPE, DISSECTING FORCEPS

Chirurgische pinzetten, Uhrmacher-Pinzetten
Pinzas de disección con dientes, Pinzas de relojero

Pinces à dissection à groffes, Pinces d'horloger
Pinze per dissezione con denti, Pinze de orologiaio

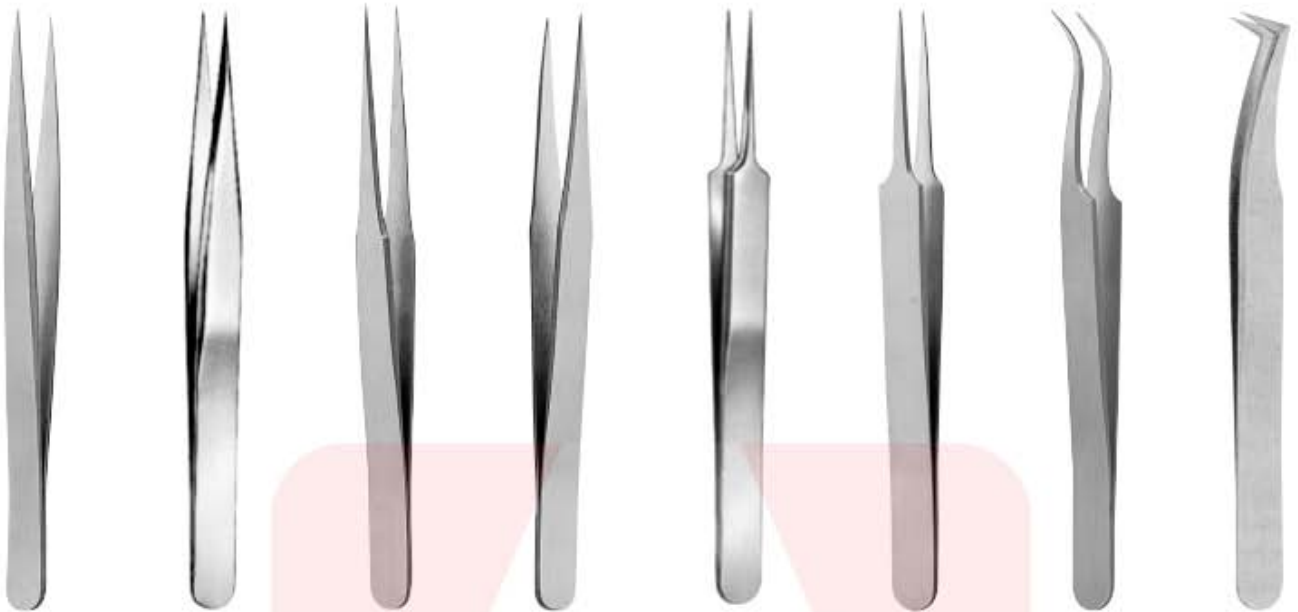

| | | | | | | | |
|------------------|------------------|------------------|------------------|------------------|------------------|------------------|------------------|
| Jewelers Forceps | Jewelers Forceps | Jewelers Forceps | Jewelers Forceps | Jewelers Forceps | Jewelers Forceps | Jewelers Forceps | Jewelers Forceps |
| LG5-264-001 | LG5-265-002 | LG5-266-003 | LG5-267-004 | LG5-268-005 | LG5-269-006 | LG5-270-007 | LG5-271-008 |



JEWELER'S FORCEPS
LG5-272-115 11.5 cm, 4 1/2"



1/4
LG5-273-105
10.5 cm, 4"



LG5-274-105
10.5 cm, 4"



LG5-275-110
11 cm, 4 1/2"



LG5-276-110
11 cm, 4 1/2"



1/4
LG5-277-110
11 cm, 4 1/2"



LG5-278-120
12 cm, 5"



LG5-279-120
12 cm, 5"



LG5-280-120
12 cm, 5"



SPLINTER FORCEPS

Splitterpinzetten
Pinzas Para espinas

Pinces à échardes
Pinze per scheggie



FEILCHENFELD

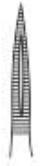

LG5-281-075 7.5 cm, 3"
LG5-282-090 9 cm, 3 1/2"
LG5-283-110 11 cm, 4"
Straight



HUNTER



LG5-284-105 10.5 cm, 4"
Straight



HUNTER



LG5-285-105 10.5 cm, 4"
Curved



CARMALT



LG5-286-105 10.5 cm, 4"
Straight



CARMALT



LG5-287-105 10.5 cm, 4"
Curved



LG5-288-080 08.0 cm, 3"
LG5-289-090 09.0 cm, 3 1/2"
LG5-290-105 10.5 cm, 4"
LG5-291-115 11.5 cm, 4 1/2"
LG5-292-125 12.5 cm, 5"
LG5-293-145 14.5 cm, 5 1/2"
Straight



LG5-294-080 08.0 cm, 3"
LG5-295-090 09.0 cm, 3 1/2"
LG5-296-105 10.5 cm, 4"
LG5-297-115 11.5 cm, 4 1/2"
LG5-298-125 12.5 cm, 5"
LG5-299-145 14.5 cm, 5 1/2"
Curved



LG5-300-080 08.0 cm, 3"
LG5-301-090 09.0 cm, 3 1/2"
LG5-302-105 10.5 cm, 4"
LG5-303-115 11.5 cm, 4 1/2"
LG5-304-125 12.5 cm, 5"
LG5-305-145 14.5 cm, 5 1/2"
Straight



LG5-306-080 08.0 cm, 3"
LG5-307-090 09.0 cm, 3 1/2"
LG5-308-105 10.5 cm, 4"
LG5-309-115 11.5 cm, 4 1/2"
LG5-310-125 12.5 cm, 5"
LG5-311-145 14.5 cm, 5 1/2"
Curved



SPLINTER FORCEPS

Splitterpinzetten
Pinzas Para espinas

Pinces à échardes
Pinze per scheggie



LG5-312-080 08.0 cm, 3"
LG5-313-090 09.0 cm, 3 1/2"
LG5-314-105 10.5 cm, 4"
LG5-315-115 11.5 cm, 4 1/2"
LG5-316-125 12.5 cm 5"
LG5-317-145 14.5 cm 6"
Straight

LG5-318-080 08.0 cm, 3"
LG5-319-090 09.0 cm, 3 1/2"
LG5-320-105 10.5 cm, 4"
LG5-321-115 11.5 cm, 4 1/2"
LG5-322-125 12.5 cm 5"
LG5-323-145 14.5 cm 6"
Curved

LG5-324-080 08.0 cm, 3"
LG5-325-090 09.0 cm, 3 1/2"
LG5-326-105 10.5 cm, 4"
LG5-327-115 11.5 cm, 4 1/2"
LG5-328-125 12.5 cm 5"
LG5-329-145 14.5 cm 6"
Straight

LG5-330-080 08.0 cm, 3"
LG5-331-090 09.0 cm, 3 1/2"
LG5-332-105 10.5 cm, 4"
LG5-333-115 11.5 cm, 4 1/2"
LG5-334-125 12.5 cm 5"
LG5-335-145 14.5 cm 6"
Curved

STIEGLITZ
FORCEPS
LG5-336-125
12.5 cm, 5"

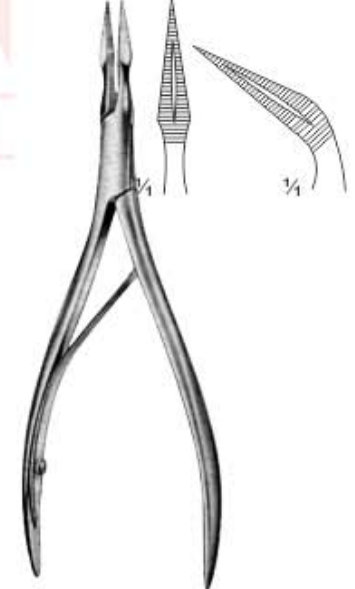
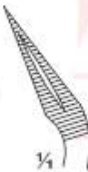
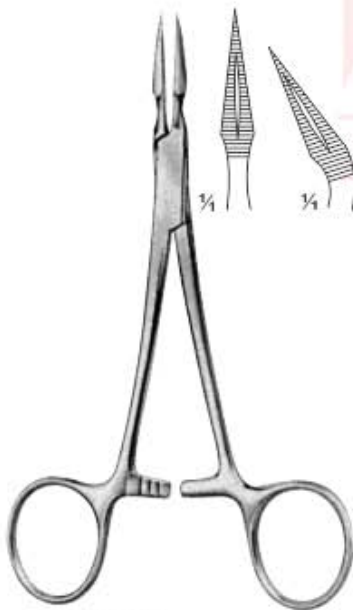

STIEGLITZ
LG5-337-140 14 cm, 5 1/2" Str.
LG5-338-140 14 cm, 5 1/2" Cvd.

STIEGLITZ
LG5-339-140 14 cm, 5 1/2" Str.
LG5-340-140 14 cm, 5 1/2" Cvd.

PEET
LG5-341-115
11.5 cm, 4 1/2"

RALK
LG5-342-150 15 cm, 6" Str.
LG5-343-150 15 cm, 6" Cvd.



NEEDLE HOLDERS

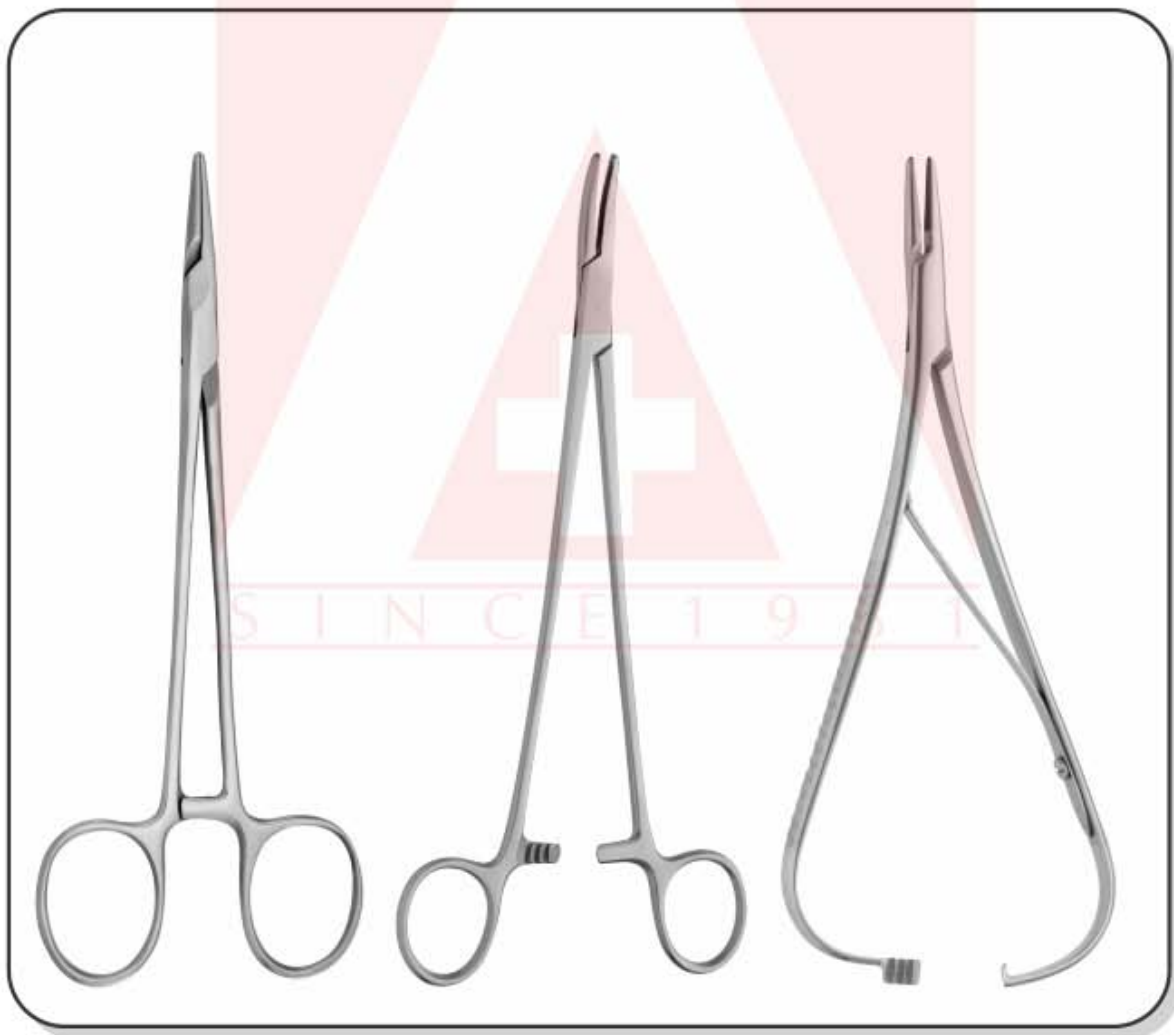



NEEDLE HOLDERS

Nadelhalter
Porta-agujas

Porte-agujas
Portaghi



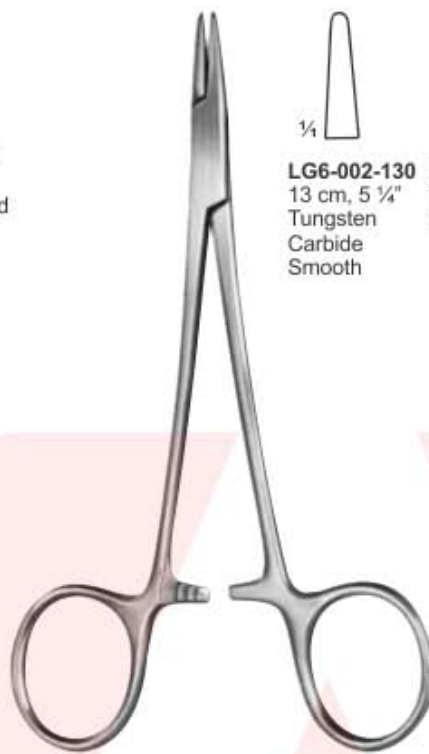

LG6-001-140
14 cm, 5 1/2"
Serrated-Solid



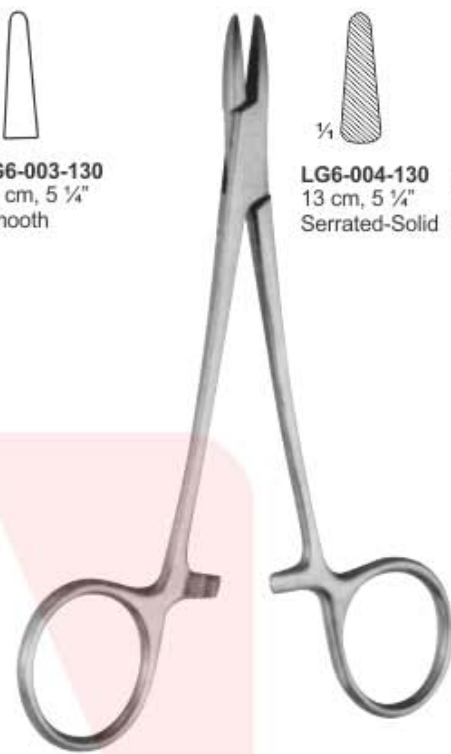

1/4
LG6-002-130
13 cm, 5 1/4"
Tungsten
Carbide
Smooth

LG6-003-130
13 cm, 5 1/4"
Smooth



1/4
LG6-004-130
13 cm, 5 1/4"
Serrated-Solid



LG6-005-190
19 cm, 7 1/2"
Serrated-Solid

BAUMGARTNER

WEBSTER

BROWN





1/4
LG6-006-140
14 cm, 5 1/2"
Serrated-Grooved



LG6-007-160
16 cm, 6 1/4"
Serrated-Grooved



LG6-008-180
18 cm, 7"
Serrated-Grooved



LG6-009-200
20 cm, 8"
Serrated-Grooved



LG6-010-240
24 cm, 9 3/4"
Serrated-Grooved



LG6-011-260
26 cm, 10 1/4"
Serrated-Grooved



LG6-012-305
30.5 cm, 12"
Serrated-Grooved



1/4
LG6-013-140
14 cm, 5 1/2"
Serrated-Grooved
Curved



LG6-014-160
16 cm, 6 1/4"
Serrated-Grooved
Curved

LG6-015-180
18 cm, 7"
Serrated-Grooved
Curved

LG6-016-200
20 cm, 8"
Serrated-Grooved
Curved

LG6-017-240
24 cm, 9 3/4"
Serrated-Grooved
Curved

LG6-018-260
26 cm, 10 1/4"
Serrated-Grooved
Curved

LG6-019-305
30.5 cm, 12"
Serrated-Grooved
Curved

MAYO-HEGAR



NEEDLE HOLDERS

Nadelhalter
Porta-agujas

Porte-agujas
Portaghi



BABY CRILE-WOOD
LG6-020-150 15 cm, 6"

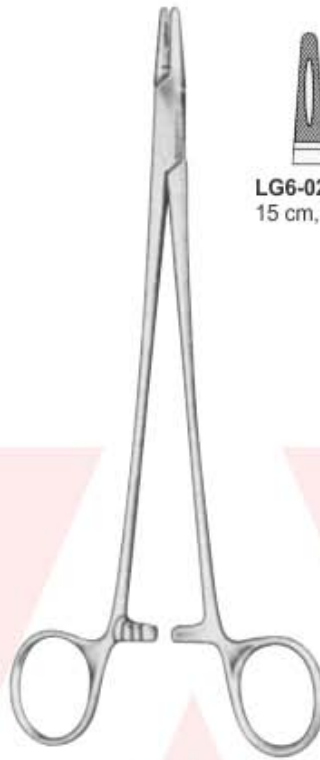

CRILE-WOOD

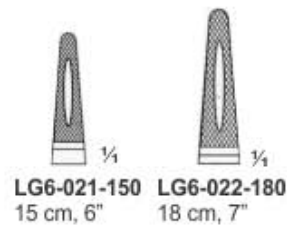

LG6-021-150 15 cm, 6"
LG6-022-180 18 cm, 7"



CARROLL
LG6-023-150 15 cm, 6"



BOZEMANN

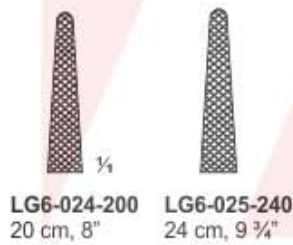

LG6-024-200 20 cm, 8"
LG6-025-240 24 cm, 9 3/4"



LG6-026-260
26 cm, 10 1/4"



METZENBAUM
LG6-027-185
18.5 cm, 7 1/4"

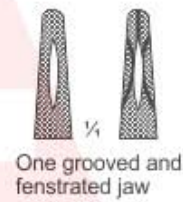

One grooved and
fenestrated jaw



COLLIER
LG6-028-125
12.5 cm, 5"



NEEDLE HOLDERS

Nadelhalter
Porta-agujas

Porte-agujas
Portaghi



JAMESON
LG6-029-235
23.5 cm, 9 1/4"



FINOCCHIETTO
LG6-030-270
27 cm, 10 3/4"

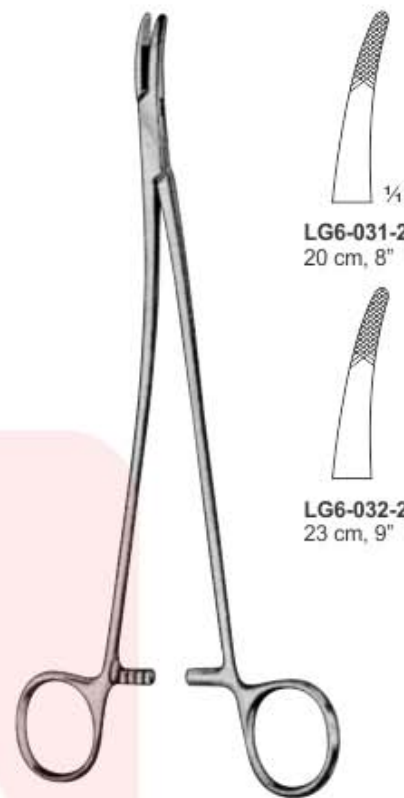

LG6-031-200
20 cm, 8"

LG6-032-230
23 cm, 9"

STRATTE



LG6-033-130 **LG6-034-180**
13 cm, 5 1/4" 18 cm, 7"

BROWN

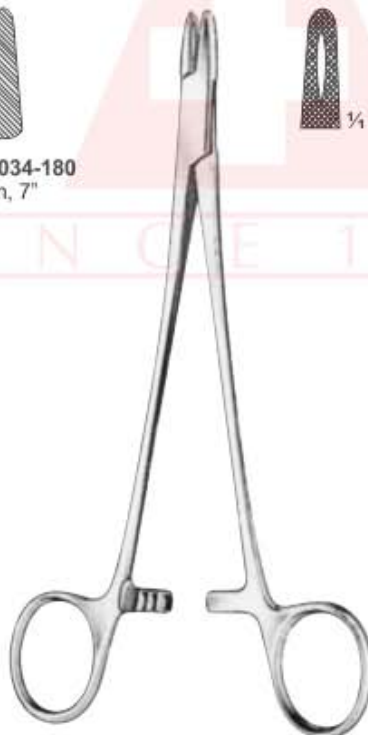

NEW ORLEANS
LG6-035-180
18 cm, 7"



LG6-036-150 **LG6-037-170**
15 cm, 6" 17 cm, 6 3/4"

SENNING
(Schwed. Model)

S I N C E 1 9 8



NEEDLE HOLDERS

Nadelhalter
Porta-agujas

Porte-agujas
Portaghi



MATHIEU



LG6-038-140
14 cm, 5 1/2"



LG6-039-170
17 cm, 6 3/4"



LG6-040-200
20 cm, 8"



MATHIEU



LG6-041-140
14 cm, 5 1/2"



LG6-042-165
16.5 cm, 6 1/2"

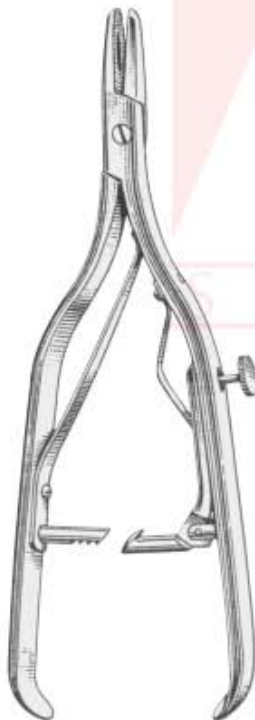

MAYO ROCHESTER
LG6-043-180 18 cm, 8"
LG6-044-230 23 cm, 9"
button release, screw joint.



LG6-045-150
15 cm, 6"



LG6-046-180 18 cm, 7"
LG6-047-200 20 cm, 8"



MACPHAIL
lined with copper.



NEEDLE HOLDERS

Nadelhalter
Porta-agujas

Porte-agujas
Portaghi



ARRUGA
LG6-048-160 16 cm, 6 1/4" Str.
LG6-049-160 16 cm, 6 1/4" Cvd.



LICHTENBERG
LG6-050-200 20 cm, 8"



TOENNIS
LG6-051-185
18.5 cm, 7 1/4"



CRILE
LG6-052-150
15 cm, 6"



**CASTROVIEJO
OLSEN HEAGER /
Needle Holders / Scissors**
LG6-053-145 14.5 cm, 5 3/4"
LG6-054-150 15.0 cm, 6"

S I N C E 1 9 8 1



NEEDLE HOLDERS

Nadelhalter
Porta-agujas

Porte-agujas
Portaghi



LG6-055-105
10.5 cm, 4"
Straight

LG6-056-105
10.5 cm, 4"
Curved

LG6-057-115
11.5 cm, 4 3/4"
Straight

LG6-058-115
11.5 cm, 4 3/4"
Curved



LG6-059-115
11.5 cm, 4 3/4"



LG6-060-135
13.5 cm, 5 1/4"

LG6-061-140
14 cm, 5 1/2"

**BARRAQUER-
TROUTMAN**

BARRAQUER



With look

CASTROVIEJO
LG6-062-120
12 cm, 5"



With look

CASTROVIEJO
LG6-063-120
12 cm, 5"





RETRACTORS





HOOKLET & SKIN HOOKS

Wundhäkchen, Mikrohäkchen
Ganchito, Micro Ganchitos

Crochet, Micro crochetes
Divaricatore, Micro Divaricatori

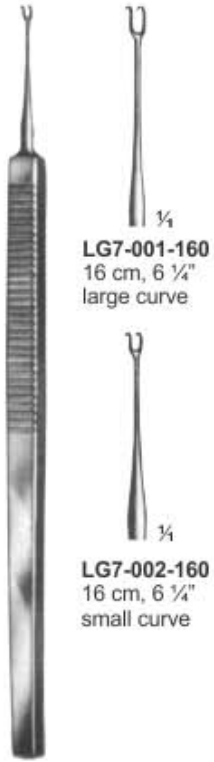

LG7-001-160
16 cm, 6 1/4"
large curve

LG7-002-160
16 cm, 6 1/4"
small curve

GUTHRIE

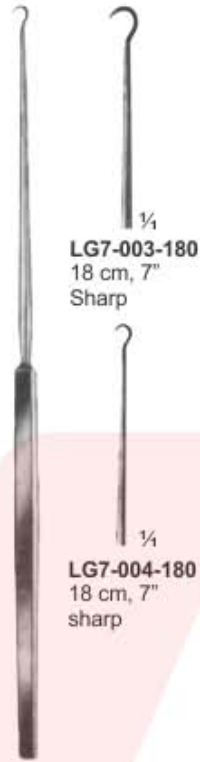

LG7-003-180
18 cm, 7"
Sharp

LG7-004-180
18 cm, 7"
sharp

GILLIES



LG7-005-150
15 cm, 6"
blunt

KILNER



LG7-006-185
18.5 cm, 7 1/4"
sharp

LG7-007-185
18.5 cm, 7 1/4"
sharp

FISCH



LG7-008-130
13 cm, 5"
LG7-009-180
18 cm, 7"
Blunt

LG7-010-130
13 cm, 5"
LG7-011-180
18 cm, 7"
Sharp

FRAZIER



DOUBLE PRONG
MICRO HOOK
LG7-012-145
Sharp, 2mm, wide jaws,
14.5 cm, 6 3/4"



WIENER HOOK
LG7-013-140
Sharp,
14 cm, 5 1/2"



TOENNIS
LG7-014-150
15 cm, 6"
Sharp



LG7-015-130
2 x sharp
13 cm, 5"

LG7-016-130
4 x sharp
13 cm, 5"

LG7-017-130
4 x blunt
13 cm, 5"

ROLLET



LG7-018-150
sharp
15 cm, 6"

FREER



HOOKLET & SKIN HOOKS

Wundhäkchen, Mikrohäkchen
Ganchito, Micro Ganchitos

Crochet, Micro crochetes
Divaricatore, Micro Divaricatori



JOSEPH
LG7-019-165
16.5 cm, 6 1/2"



COTTLE
LG7-023-160
16 cm, 6 1/4"
Sharp

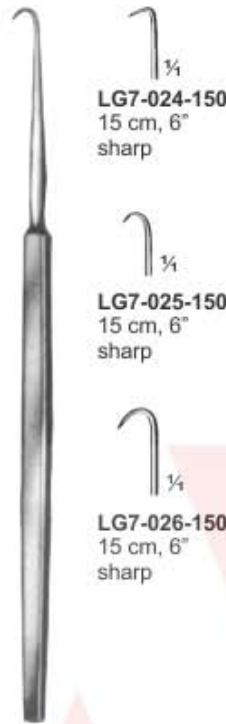

COTTLE

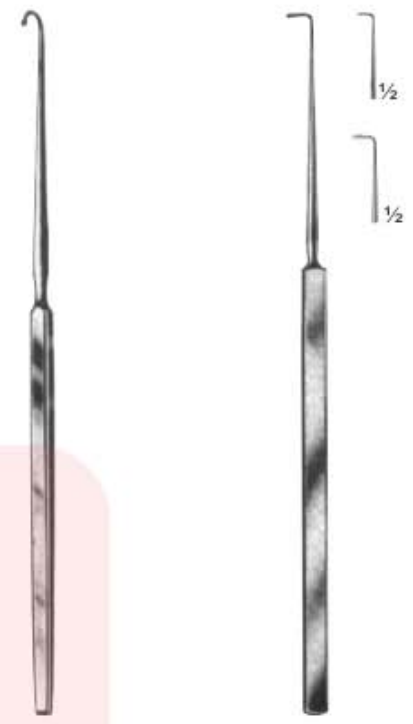

FOMON
LG7-027-170
17 cm, 6 3/4"
blunt

CUSHING
LG7-028-190
19 cm, 7 1/2" blunt
LG7-029-190
19 cm, 7 1/2" sharp
Nerve & vessel hook

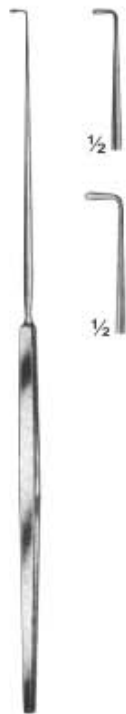

CUSHING
LG7-030-280
28 cm, 11" blunt
LG7-031-280
28 cm, 11" sharp
Nerve & vessel hook



CUSHING
LG7-032-190
19 cm, 7 1/2"

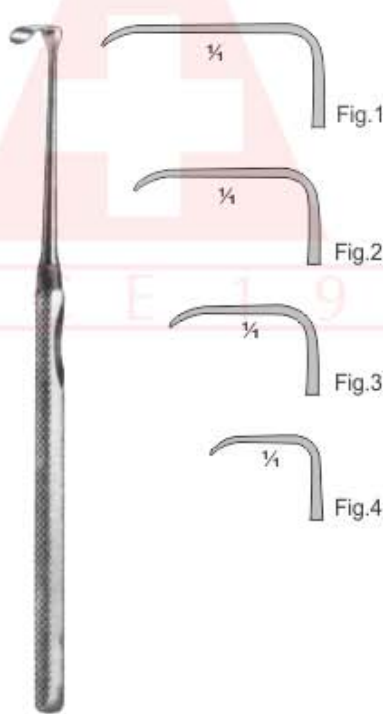

MANNERFELT-LANGENBECK
LG7-033-155 15 x 6 mm 15.5 cm, 6" Fig.1
LG7-034-155 20 x 8 mm 15.5 cm, 6" Fig.2
LG7-035-155 25 x 6 mm 15.5 cm, 6" Fig.3
LG7-036-155 30 x 8 mm 15.5 cm, 6" Fig.4

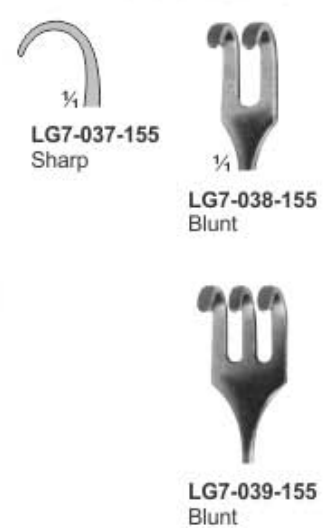

MANNERFELT
15.5 cm, 6"
large curve, blunt



HOOKLET & SKIN HOOKS

Wundhäkchen, Mikrohäkchen
Ganchito, Micro Ganchitos

Crochet, Micro crochetes
Divaricatore, Micro Divaricatori

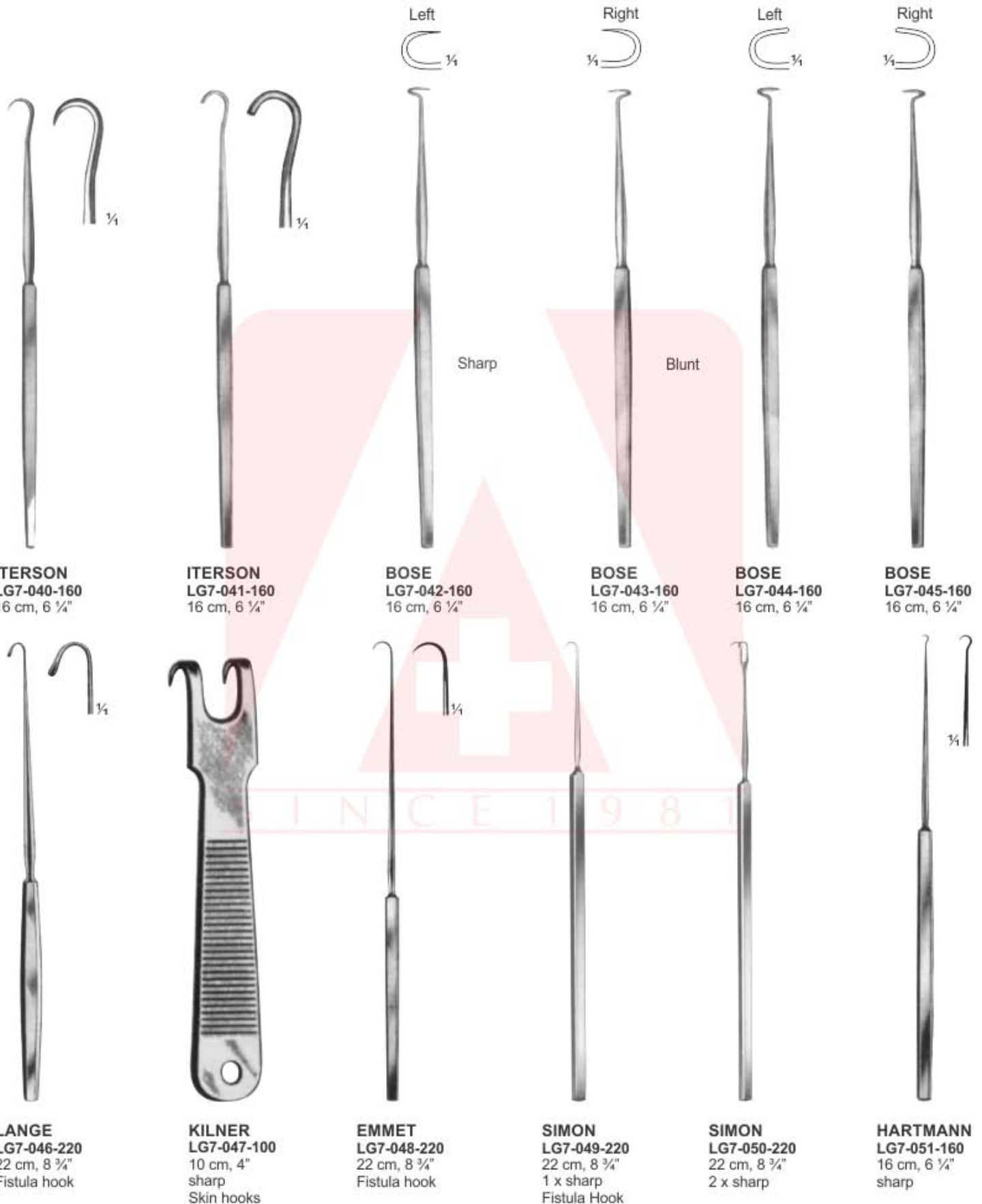



HOOKLETS, RETRACTORS

Wundhäkchen, Wundhaken
Ganchito, Separadores

Crochet, Ecarteurs
Divaricatore, Divaricatori



LG7-052-165
16.5 cm, 6 1/2"



LG7-053-165

1/4
Sharp



LG7-054-165



LG7-055-165



1/2
LG7-056-165



LG7-057-165
16.5 cm, 6 1/2"

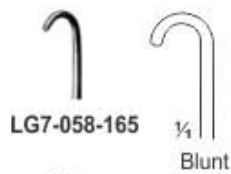

LG7-058-165

1/4
Blunt



LG7-059-165



LG7-060-165



1/2
LG7-061-165



ROLLET
LG7-062-125
12.5 cm, 4 3/4"



ROLLET (Blair)
LG7-063-135
13.5 cm, 5"



LG7-064-135
13.5 cm, 5 1/4"

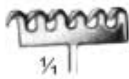

1/4



MILLER
13.5 cm, 5 1/4"



1/4
Sharp

LG7-065-135



1/4
Blunt

LG7-066-135

4x12mm



1/4



GROENHOLM
LG7-067-130
13 cm, 5"



BROM
LG7-068-170
17 cm, 6 3/4"

SINCE 1981



HOOKLETS, RETRACTORS

Wundhäkchen, Wundhaken
Ganchito, Separadores

Crochet, Ecarteurs
Divaricatore, Divaricatori



16.5 cm, 6 1/2"



Sharp



LG7-069-165



LG7-070-165



Blunt



LG7-073-165



LG7-074-165



LG7-071-165



LG7-072-165



16.5 cm, 6 1/2"



LG7-075-165



LG7-076-165



16 cm, 6 1/4"
flexible



LG7-077-160



LG7-078-160



LG7-083-165
sharp



LG7-084-165
blunt



LG7-079-160



LG7-080-160



LG7-081-160



LG7-082-160



16.5 cm, 6 1/2"
flexible



HOOKLETS, RETRACTORS

Wundhäkchen, Wundhaken
Ganchito, Separadores

Crochet, Ecarteurs
Divaricatore, Divaricatori

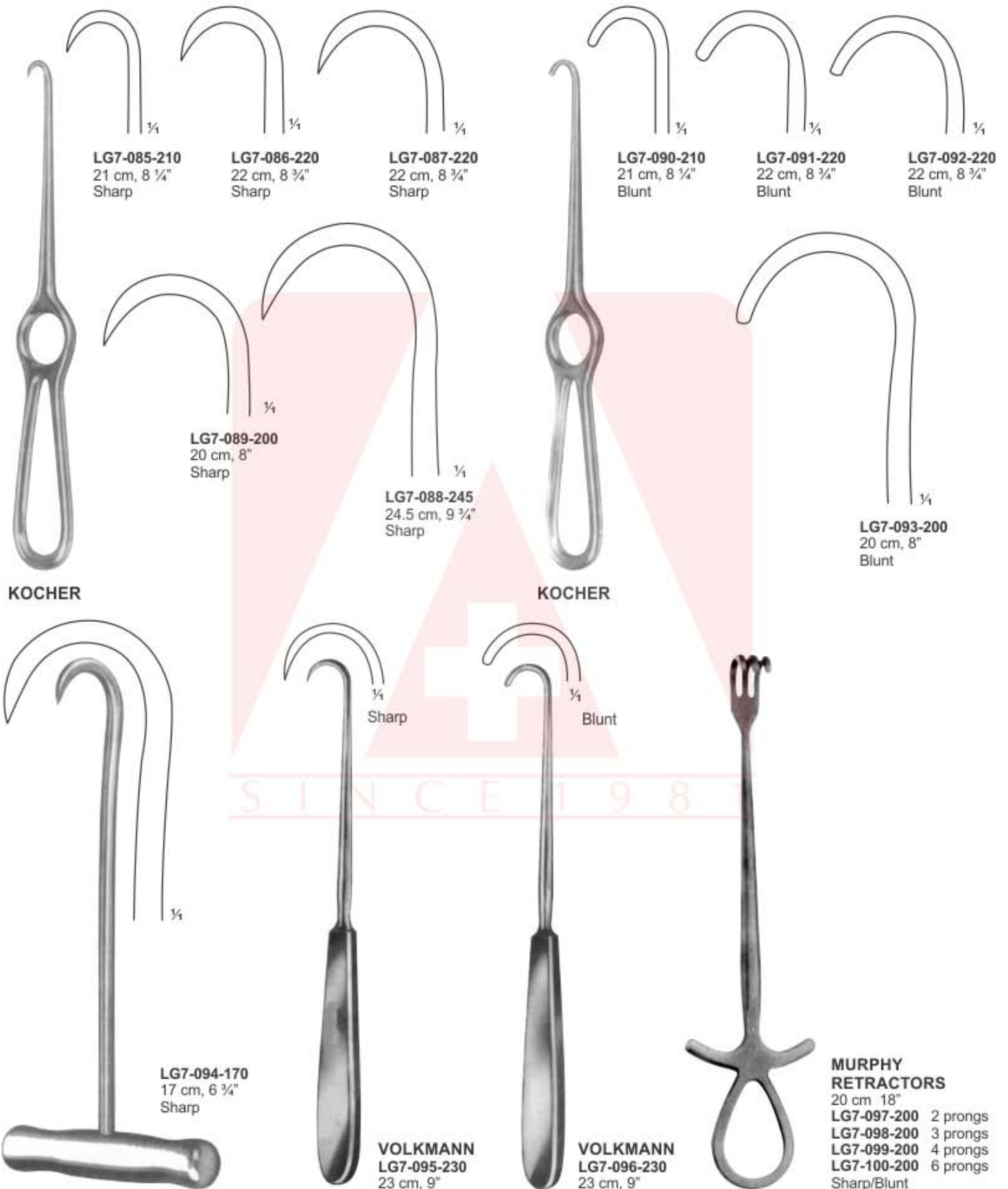



HOOKLETS, RETRACTORS

Wundhäkchen, Wundhaken
Ganchito, Separadores

Crochet, Ecarteurs
Divaricatore, Divaricatori

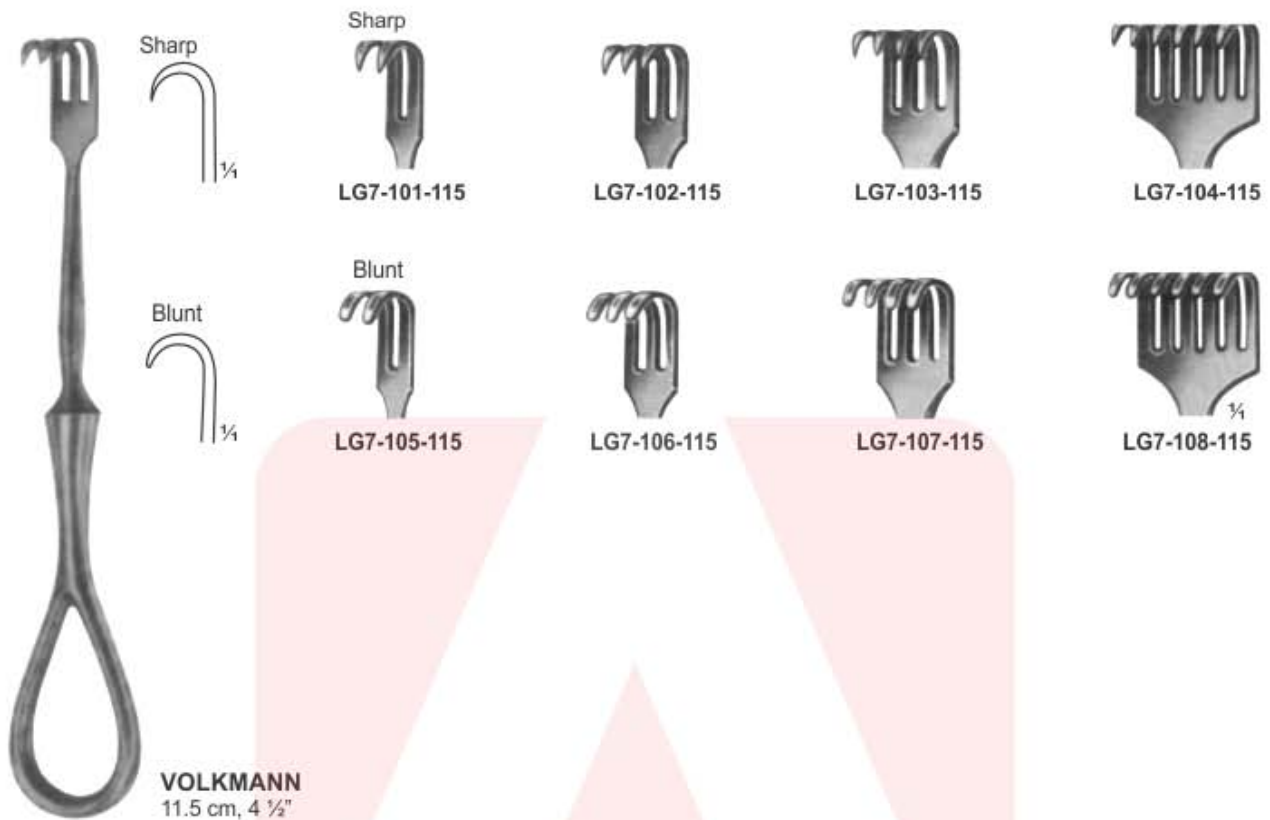

LANGENBECK-
MINI

RETRACTOR



HOOKLETS, RETRACTORS

Wundhäkchen, Wundhaken
Ganchito, Separadores

Crochet, Ecarteurs
Divaricatore, Divaricatori



LUKENS
LG7-117-170
17 cm, 6 3/4"



COPE
LG7-118-180
18 cm, 7"



**SENN MALLOW
RETRACTOR**
LG7-119-160
Blunt
16 cm, 6 1/4"



**SENN MALLOW
RETRACTOR**
LG7-120-160
Sharp
16 cm, 6 1/4"



**BABY-SENN
MUELLER**
LG7-121-160
7 x 8.5 mm
16 cm, 6 1/4"
sharp/blunt



SENN-MUELLER
LG7-122-160
18 x 6 mm
16 cm, 6 1/4"
sharp



**VOLKMAN
RETRACTOR**
LG7-123-220
Sharp, 4 Prongs
22 cm, 8 3/4"



**VOLKMAN
RETRACTOR**
LG7-124-220
Blunt, 4 Prongs
22 cm, 8 3/4"





RETRACTORS

Wundhaken
Separadores

Ecarteurs
Divaricatori



STERNBERG
LG7-125-120 12 cm, 4 3/4"
LG7-126-140 14 cm, 5 1/2"
LG7-127-160 16 cm, 6 1/4"

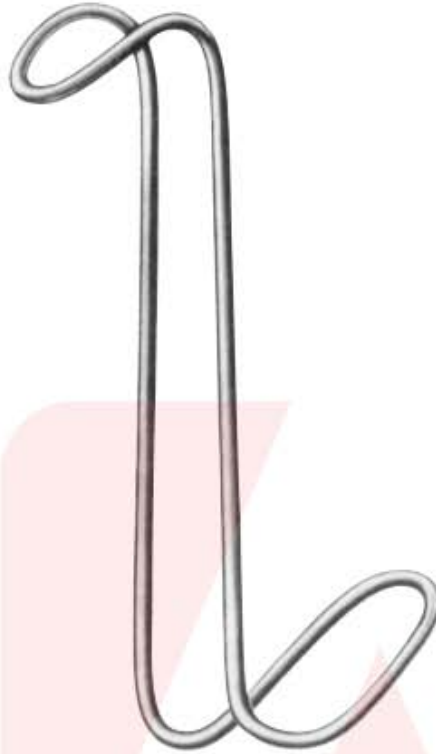

COLLIN-HARTMANN
LG7-128-140
38 x 28 / 32 x 21 mm 14 cm, 5 1/2"
LG7-129-160
52 x 34 / 36 x 27 mm 16 cm, 6 1/4"



STRANDELL-STILLE
LG7-130-190
19 cm, 7 1/2"



STRANDELL-STILLE
LG7-131-190
19 cm, 7 1/2"



KONIG



LG7-132-170
13 x 13 mm
17 cm, 6 3/4"



LG7-133-170
12 x 16 mm
17 cm, 6 3/4"



SENN-GREEN



LG7-134-150
10 x 6 mm
15 cm, 6"



LG7-135-150
20 x 6 mm
15 cm, 6"



COTTLE
LG7-136-150
10 x 12 mm
15 cm, 6"



RAGNELL-DAVIS
LG7-137-140 8 x 4 mm
LG7-138-140 15 x 5.5 mm
14 cm, 5 1/2"





HOOKLETS

Wundhäkchen

Ganchito

Crochet

Divaricatore



LG7-139-200
8 mm
20 cm, 8"



LG7-140-200
10 mm
20 cm, 8"



LG7-141-200
12 mm
20 cm, 8"



LG7-142-200
14 mm
20 cm, 8"



LG7-143-200
16 mm
20 cm, 8"



LG7-144-200
18 mm
20 cm, 8"



LG7-145-240
8 mm
24 cm, 9 1/2"



LG7-146-240
10 mm
24 cm, 9 1/2"



LG7-147-240
12 mm
24 cm, 9 1/2"



LG7-148-240
14 mm
24 cm, 9 1/2"



LG7-149-240
16 mm
24 cm, 9 1/2"



LG7-150-240
18 mm
24 cm, 9 1/2"

CUSHING

CUSHING



LG7-151-240
11 x 14 mm
24 cm, 9 1/2"



LG7-152-240
13 x 18 mm
24 cm, 9 1/2"



LG7-153-240
15 x 22 mm
24 cm, 9 1/2"



LG7-154-180
10 x 10 mm
18 cm, 7"



LG7-155-160
7 x 8 mm
16 cm, 6 1/4"



LG7-156-160
9 x 10 mm
16 cm, 6 1/4"



LG7-157-160
9 x 12 mm
16 cm, 6 1/4"



LG7-158-160
11 x 14 mm
16 cm, 6 1/4"



LG7-159-160
13 x 16 mm
16 cm, 6 1/4"



LG7-160-160
13 x 18 mm
16 cm, 6 1/4"

CUSHING

CUSHING-KOCHER

DESMARRES



HOOKLETS & SKIN HOOKS, RETRACTORS

Wundhäkchen, Mikrohäkchen, Wundhaken
Ganchito, Micro Ganchitos, Separadores

Crochet, Micro crochets, Ecarteurs
Divaricatore, Micro Divaricatori, Divaricatori



FOMON
LG7-161-170
17 cm, 6 3/4"
blunt



CUSHING
LG7-162-190 19 cm, 7 1/2" blunt
LG7-163-190 19 cm, 7 1/2" sharp
Nerve-and
vessel hook



CUSHING
LG7-164-280 28 cm, 11" blunt
LG7-165-280 28 cm, 11" sharp
Nerve-and
vessel hook



CUSHING
LG7-166-190
19 cm, 7 1/2"



ZENKER

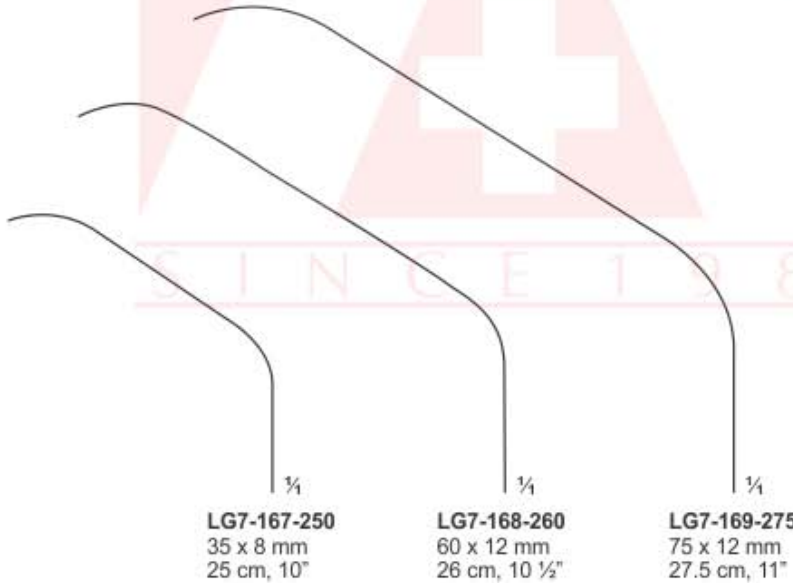

KOCHER
19 cm, 7 1/2"



LG7-170-190
19 x 12 mm



LG7-171-190
21 x 15 mm



RETRACTORS

Wundhaken
Separadores

Ecarteurs
Divaricatori

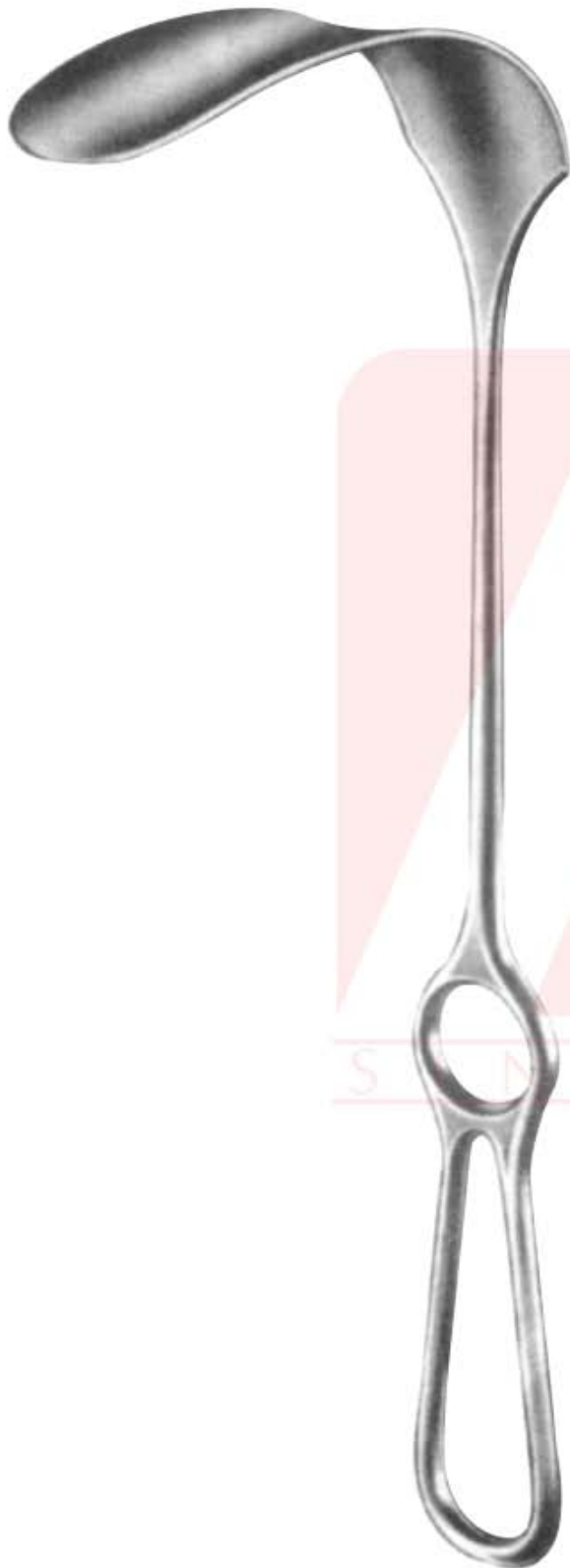

KOCHER
28 cm 11"



LG7-172-280

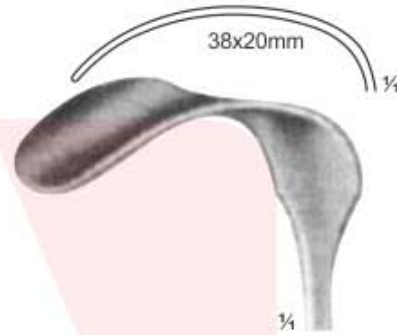

LG7-173-280

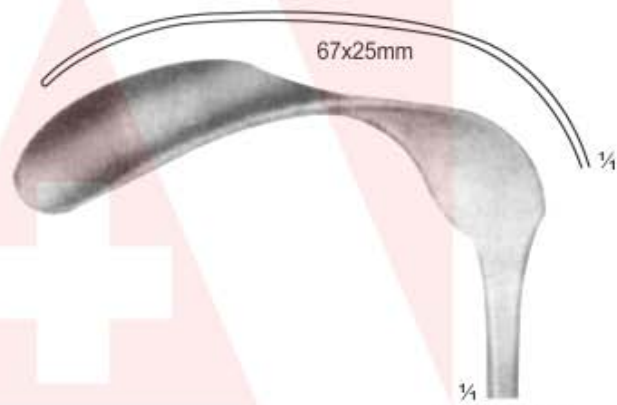

LG7-174-280

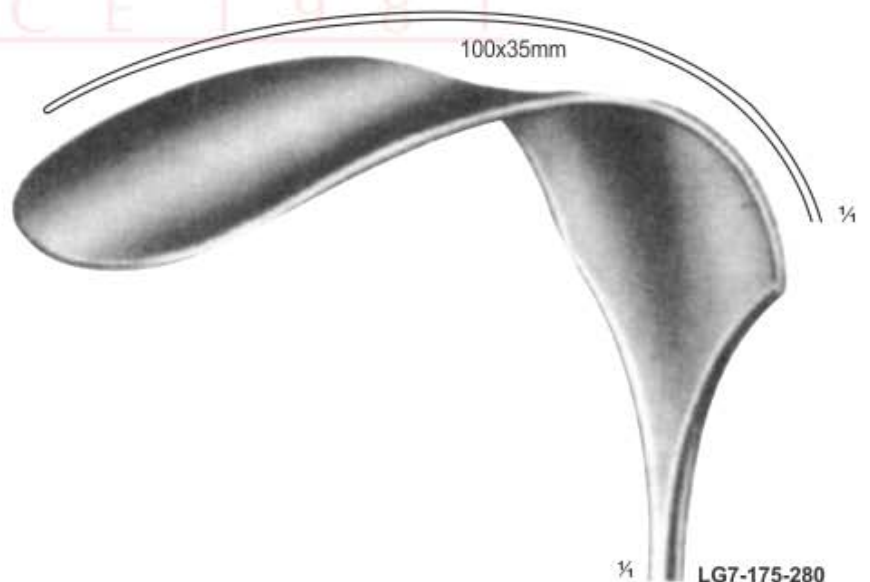

LG7-175-280



RETRACTORS

Wundhaken
Separadores

Ecarteurs
Divaricatori



MIDDELDORPF



LG7-176-210
14 x 17 mm
21 cm, 8 1/4"



LG7-177-210
20 x 22 mm
21 cm, 8 1/4"



LG7-178-210
26 x 30 mm
21 cm, 8 1/4"



LANGENBECK
LG7-179-215
21.5 cm 8 1/2"
Handle vertical
to the blade



LANGENBECK
20 cm, 8"



LG7-180-200
20 x 7 mm
20 cm, 8"



LG7-181-200
30 x 7 mm
20 cm, 8"



LG7-182-200
30 x 11 mm
20 cm, 8"



LG7-183-200
30 x 15 mm
20 cm, 8"



LG7-184-200
30 x 20 mm
20 cm, 8"



LG7-185-200
44 x 10 mm
20 cm, 8"



LG7-186-200
44 x 15 mm
20 cm, 8"



LG7-187-200
45 x 20 mm
20 cm, 8"



LG7-188-200
50 x 20 mm
20 cm, 8"

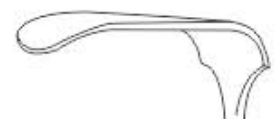

LG7-189-200
60 x 20 mm
20 cm, 8"

S I N C E 1 9 8 1



RETRACTORS

Wundhaken
Separadores

Ecarteurs
Divaricatori



WASSMUND
LG7-190-200
20 cm, 8"
33 x 20mm



LITTLE
LG7-191-200
20 cm, 8"
12x14 mm



LANGENBECK
LG7-192-210
21 cm 8 1/4"
38 x 9 mm



LG7-193-240
35 x 7mm



LG7-194-240
35 x 11mm



LANGENBECK
24 cm, 8 1/4"



LG7-195-240
35 x 15mm



LG7-196-240
35 x 20mm





RETRACTORS

Wundhaken
Separadores

Ecarteurs
Divaricatori



LG7-197-215 14 x 17 mm
21.5 cm, 8 1/2"



LG7-200-215 14 x 17 mm
21.5 cm, 8 1/2"



LG7-198-220 20 x 22 mm
22 cm, 8 3/4"



LG7-201-220 20 x 22 mm
22 cm, 8 3/4"

LG7-199-235 26 x 30 mm
23.5 cm, 9 1/4"



LG7-202-235 26 x 30 mm
23.5 cm, 9 1/4"

MIDDELDORPF

MIDDELDORPF



LG7-204-255 45 x 50 mm
25.5 cm, 10"

1/4



LG7-205-255 55 x 70 mm
25.5 cm, 10"

1/4



LG7-206-220 25 x 12mm
22 cm, 8 3/4"

1/4

MIDDELDORPF
LG7-203-255 45 x 45 mm
25.5 cm, 10"

GREEN
22 cm, 8 3/4"



RETRACTORS

Wundhaken
Separadores

Ecarteurs
Divaricatori



 ¼
LG7-207-170
17 cm, 6 ¾"
15 x 6 mm
Fig. 1
blunt

 ¼
LG7-208-170
17 cm, 6 ¾"
15 x 6 mm
Fig. 2
toothed

**STRANDELL-
STILLE**



SCHOENBORN
LG7-209-210
21 cm, 8 ¼"



TENDON HOOKS
LG7-210-175 17.5 cm, 7"
LG7-211-175 17.5 cm, 7"
12 x 6 mm Fig. 1
12 x 11 mm Fig. 2



KLAPP
LG7-212-175
15 x 11 mm
17.5 cm, 7"



LANGENBECK
LG7-213-225
22.5 cm 8 ¾"
37 x 9 mm



LANGENBECK
LG7-214-210
21 cm 8 ¼"
85 x 15 mm
Handle vertical to blade



LANGENBECK
LG7-215-210
21 cm, 8 ¼"
53 x 20 mm
LG7-216-210
21 cm, 8 ¼"
61 x 20 mm



MEYERDING
18 cm, 7"



¼
LG7-217-180
18 x 7 mm
Blunt



¼
LG7-218-180
16 x 5 mm
Toothed



¼
LG7-219-180
7 x 4 mm
Toothed



¼
LG7-220-180
10 x 3 mm
Blunt



¼
LG7-221-180
7 x 4 mm
Saddle Shaped



¼
LG7-222-180
10 x 4 mm
Sharp





RETRACTORS

Wundhaken
Separadores

Ecarteurs
Divaricatori



BLOUNT
LG7-223-175
17.5 cm, 6 3/4"
42 x 4 mm



TAYLOR
Spinal Retractors
LG7-224-165 16.5 cm, 6 1/2"
75 x 30 mm
LG7-225-165 16.5 cm, 6 1/2"
100 x 30 mm



LUER
LG7-226-110 11 cm, 4 1/4"
10 x 8 mm
LG7-227-110 11 cm, 4 1/4"
12 x 11 mm



ROSE
LG7-228-130 13 cm, 5"
12 x 12 mm
12 x 15 mm



20 x 6 mm
12 x 4 mm
CRILE
LG7-229-110 11 cm, 4 1/4"
12 x 4 mm
20 x 6 mm



MATHIEU
Set 2 pcs.
LG7-230-200 20 cm, 8"
47 x 13 / 46 x 26 mm
LG7-231-200 20 cm, 8"
42 x 13 / 42 x 26 mm



US-ARMY
Set 2 pcs.
LG7-232-215 21.5 cm, 8 1/2"
28 x 15 / 42 x 15 mm
LG7-233-215 21.5 cm, 8 1/2"
25 x 15 / 38 x 15 mm



RICHARDSON EASTMAN
LG7-234-260
26 cm, 10 1/4"
small



RICHARDSON EASTMAN
LG7-235-280
28 cm, 11"



USA RETRACTORS
LG7-236-001
set of 6 pec.





RETRACTORS

Wundhaken
Separadores

Ecarteurs
Divaricatori

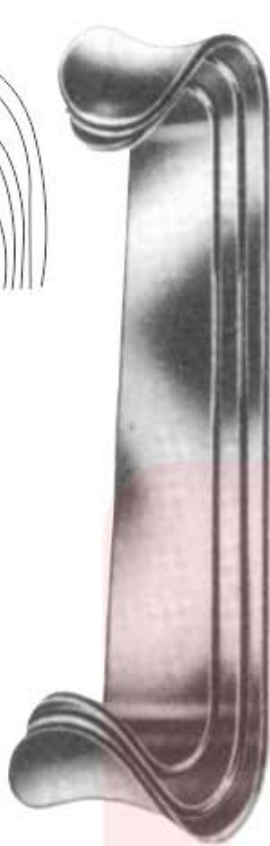
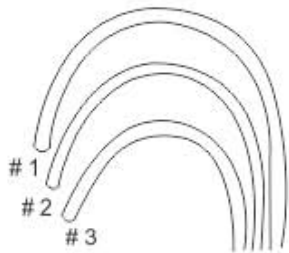

ROUX

Set 3 pcs. consisting of

- # 1 LG7-237-140 14 cm, 5 1/2" 24 x 20 / 30 x 28 mm
- # 2 LG7-238-150 15 cm, 6" 29 x 26 / 36 x 36 mm
- # 3 LG7-239-170 17 cm, 6 3/4" 33 x 29 / 38 x 43 mm

BABY-ROUX

- LG7-240-130 13 cm, 5" 15 x 15 mm
- 18 x 21 mm

ROUX

- LG7-241-165 16.5 cm, 6 1/2"

ROUX

- LG7-242-185 18.5 cm, 7 1/4"

28 x 23 mm

28 x 27 mm

43 x 23 mm

45 x 27 mm

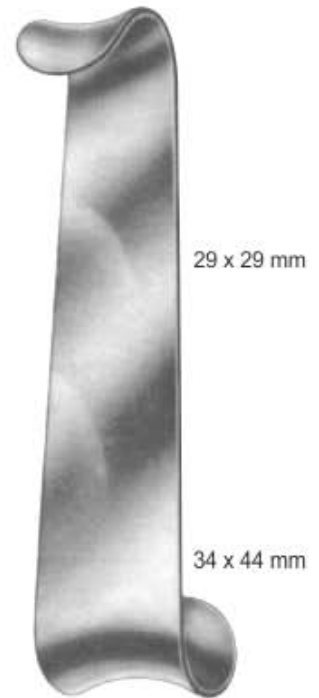
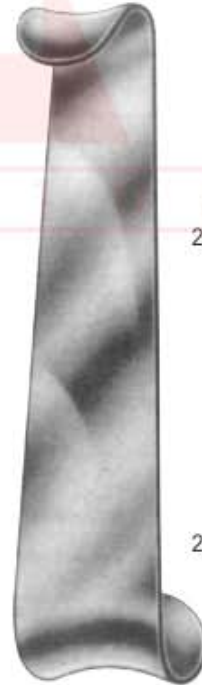

20 x 22 mm

23 x 26 mm

29 x 29 mm

25 x 38 mm

29 x 38 mm

34 x 44 mm

- MINI-ROUX**
LG7-243-140
14 cm, 5 1/2"

- ROUX-MAGNUS**
LG7-244-150
15 cm, 6"

- ROUX-MAGNUS**
LG7-245-160
16 cm, 6 1/4"

- ROUX-MAGNUS**
LG7-246-170
17 cm, 6 3/4"



RETRACTORS

Wundhaken
Separadores

Ecarteurs
Divaricatori



FARABEUW

Set 2 Pcs.

LG7-247-130 13 cm, 5"
30 x 10 / 34 x 13 mm
LG7-248-130 13 cm, 5"
26 x 10 / 30 x 13 mm



FARABEUW

Set 2 Pcs.

LG7-249-150 15 cm, 6"
27 x 16 / 30 x 16 mm
LG7-250-150 15 cm, 6"
23 x 16 / 26 x 16 mm



PARKER

Set 2 pcs.

LG7-251-135 13.5 cm, 5 1/4"
22 x 15 mm / 22 x 15 mm



PARKER

LG7-252-135 13.5 cm, 5 1/4"
18 x 15 mm / 19 x 15 mm

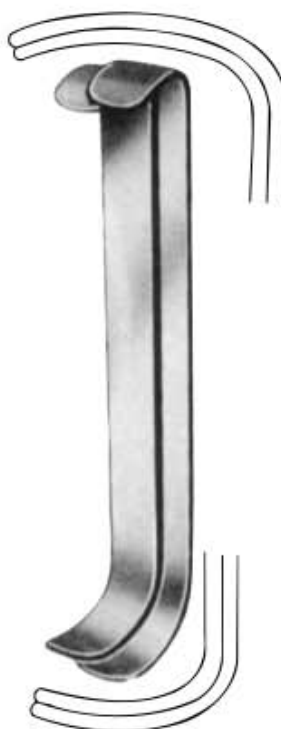

COLLIN

Set 2 pcs.

LG7-253-165 16.5 cm, 6 1/2"
25 x 12 / 35 x 16 mm
LG7-254-165 16.5 cm, 6 1/2"
20 x 12 / 30 x 16 mm



MAYO-COLLIN

Set 2 pcs.

LG7-255-150 15 cm, 6"
28 x 18 / 25 x 18 mm



PARKER-LANGENBECK

Set of 2 Pcs.

LG7-256-215 21.5 cm, 8 1/2" 25 x 15 mm fig. 2
LG7-257-215 21.5 cm, 8 1/2" 21 x 15 mm fig. 1
LG7-258-215 21.5 cm, 8 1/2" 40 x 15 mm fig. 1
LG7-259-215 21.5 cm, 8 1/2" 46 x 15 mm fig. 2

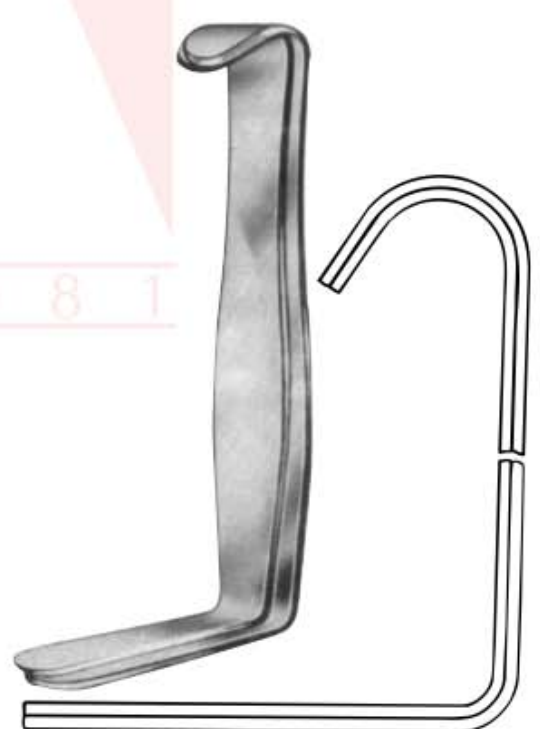

PARKER-MOTT

LG7-260-160

16 cm 6 1/4"
68 x 24 / 74 x 24 mm

SINCE 1981



RETRACTORS

Wundhaken
Separadores

Ecarteurs
Divaricatori

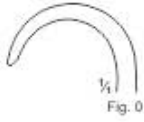

KOCHER
Sharp

- LG7-261-220 22 cm, 8 3/4" 15 x 10 mm Fig. 1
- LG7-262-220 22 cm, 8 3/4" 15 x 15 mm Fig. 2
- LG7-263-220 22 cm, 8 3/4" 15 x 20 mm Fig. 3
- LG7-264-220 22 cm, 8 3/4" 15 x 30 mm Fig. 4
- LG7-265-220 22 cm, 8 3/4" 15 x 40 mm Fig. 5

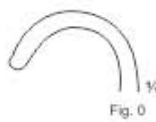
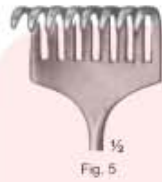

KOCHER
Blunt

- LG7-266-220 22 cm, 8 3/4" 15 x 10 mm Fig. 1
- LG7-267-220 22 cm, 8 3/4" 15 x 15 mm Fig. 2
- LG7-268-220 22 cm, 8 3/4" 15 x 20 mm Fig. 3
- LG7-269-220 22 cm, 8 3/4" 15 x 30 mm Fig. 4
- LG7-270-220 22 cm, 8 3/4" 15 x 40 mm Fig. 5

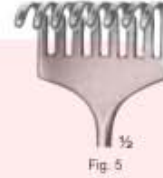

- LG7-271-222 Blunt, 2 prongs.
- LG7-272-222 Blunt, 3 prongs.
- LG7-273-222 Blunt, 4 prongs.
- LG7-274-222 Blunt, 5 prongs.
- LG7-275-222 Blunt, 6 prongs.

- LG7-276-222 Sharp, 2 prongs.
- LG7-277-222 Sharp, 3 prongs.
- LG7-278-222 Sharp, 4 prongs.
- LG7-279-222 Sharp, 5 prongs.
- LG7-280-222 Sharp, 6 prongs.



VOLKMANN
RETRACTORS
Long Pattern
22.2 cm, 9"



KOERTE
blunt
LG7-282-240
26 x 40 mm
24 cm, 9 1/2"

KOERTE
sharp
LG7-281-240
26 x 40 mm
24 cm, 9 1/2"



KOERTE
blunt
LG7-283-230
46 x 55 mm
23 cm, 9"



KOERTE
semi-sharp
LG7-284-280
25 x 40 mm
28 cm, 11"



KOERTE
LG7-285-230
23 cm, 9"
Blunt



**KORTE-
WAGNER**
LG7-286-280
28 cm, 11"
blunt



RETRACTORS

Wundhaken
Separadores

Ecarteurs
Divaricatori



VOLKMANN

Sharp

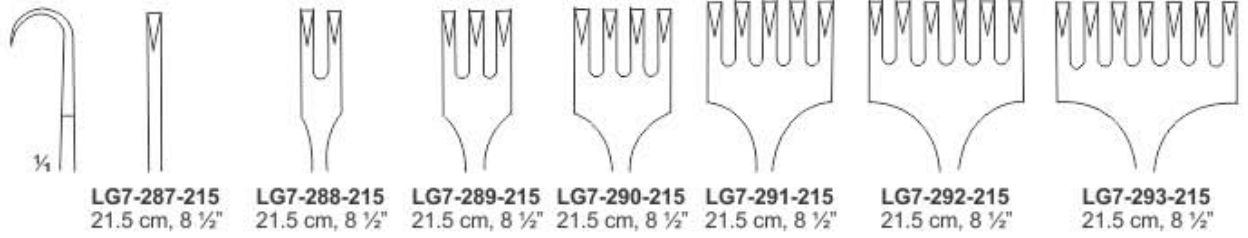

Blunt

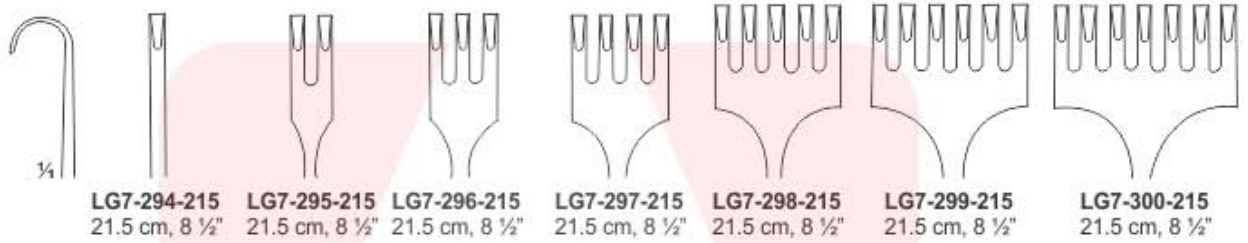

Sharp

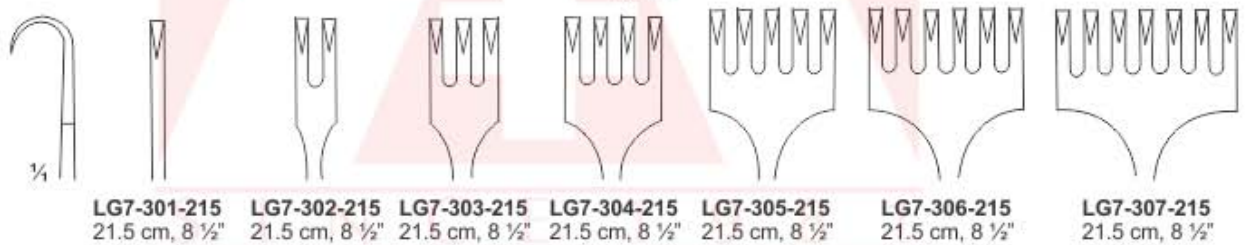

Blunt

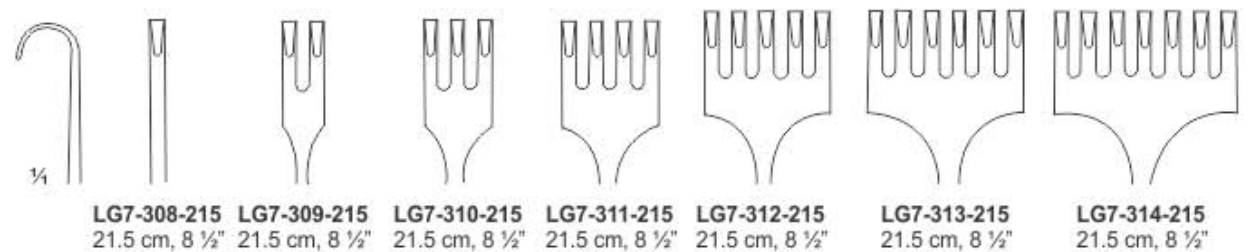

VOLKMANN



RETRACTORS

Wundhaken
Separadores

Ecarteurs
Divaricatori



KOCHER-LANGENBECK



LG7-315-215
25 x 6 mm
21.5 cm, 8 1/2"



LG7-316-215
35 x 8 mm
21.5 cm, 8 1/2"



LG7-317-215
35 x 11 mm
21.5 cm, 8 1/2"



LG7-318-215
35 x 15 mm
21.5 cm, 8 1/2"



LG7-319-215
40 x 11 mm
21.5 cm, 8 1/2"



LG7-320-215
55 x 11 mm
21.5 cm, 8 1/2"



LG7-321-215
70 x 14 mm
21.5 cm, 8 1/2"



LG7-322-215
80 x 12 mm
21.5 cm, 8 1/2"



LG7-323-215
80 x 16 mm
21.5 cm, 8 1/2"



CASPAR



LG7-324-210
40 x 12 mm
21 cm, 8 1/4"



LG7-325-210
55 x 14 mm
21 cm, 8 1/4"

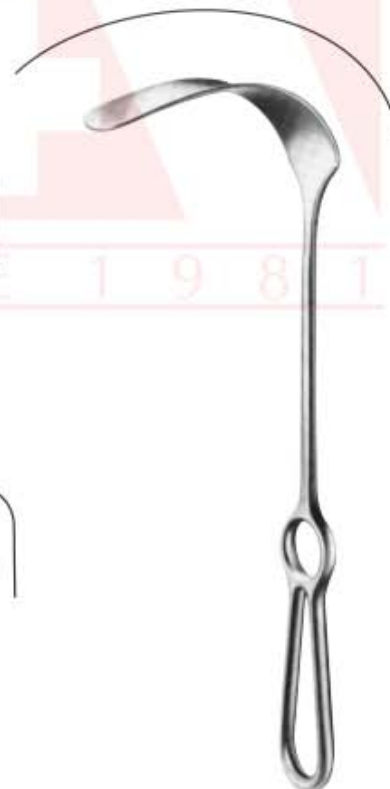

KOCHER-
WAGNER



LG7-326-280
22 x 15 mm
28 cm, 11"



LG7-327-280
38 x 20 mm
28 cm, 11"



LG7-328-280
67 x 25 mm
28 cm, 11"



RETRACTORS

Wundhaken
Separadores

Ecarteurs
Divaricatori



LG7-330-220
25 x 6 mm

LG7-337-220
25 x 6 mm

LG7-331-220
35 x 8 mm

LG7-338-220
35 x 8 mm

LG7-332-220
35 x 11 mm

LG7-339-220
35 x 11 mm

LG7-333-220
35 x 15 mm

LG7-340-220
35 x 15 mm

LG7-334-220
41 x 11 mm

LG7-341-220
41 x 11 mm

LG7-335-220
55 x 11 mm

LG7-342-220
55 x 11 mm

LG7-336-220
70 x 14 mm

LG7-343-220
70 x 14 mm

LANGENBECK
LG7-329-220
22 cm, 8 1/2"

LANGENBECK
LG7-344-220
22 cm, 8 1/2"



RETRACTORS

Wundhaken
Separadores

Ecarteurs
Divaricatori



KOCHER
LG7-345-220 40 x 10 mm
22 cm, 8 3/4"
LG7-346-220 40 x 15 mm
22 cm, 8 3/4"
LG7-347-220 40 x 20 mm
22 cm, 8 1/2"



KOCHER
LG7-348-225
70 x 25 mm
22.5 cm 8 3/4"



KOCHER
LG7-349-230 23 cm, 9" 35 x 18 mm
LG7-350-230 23 cm, 9" 60 x 20 mm
LG7-351-230 23 cm, 9" 60 x 25 mm
LG7-352-230 23 cm, 9" 75 x 30 mm
LG7-353-230 23 cm, 9" 75 x 40 mm



KOCHER
LG7-354-250 25 cm, 9 3/4" 80 x 45 mm
LG7-355-250 25 cm, 9 3/4" 80 x 55 mm
LG7-356-250 25 cm, 9 3/4" 80 x 65 mm



DOYEN-STILLE
A LG7-357-260 26 cm, 10 1/4"
97 x 29 mm
B LG7-358-260 26 cm, 10 1/4"
101 x 31 mm
C LG7-359-260 26 cm, 10 1/4"
152 x 27 mm

S I N C E 1 9 8 1



RETRACTORS

Wundhaken
Separadores

Ecarteurs
Divaricatori

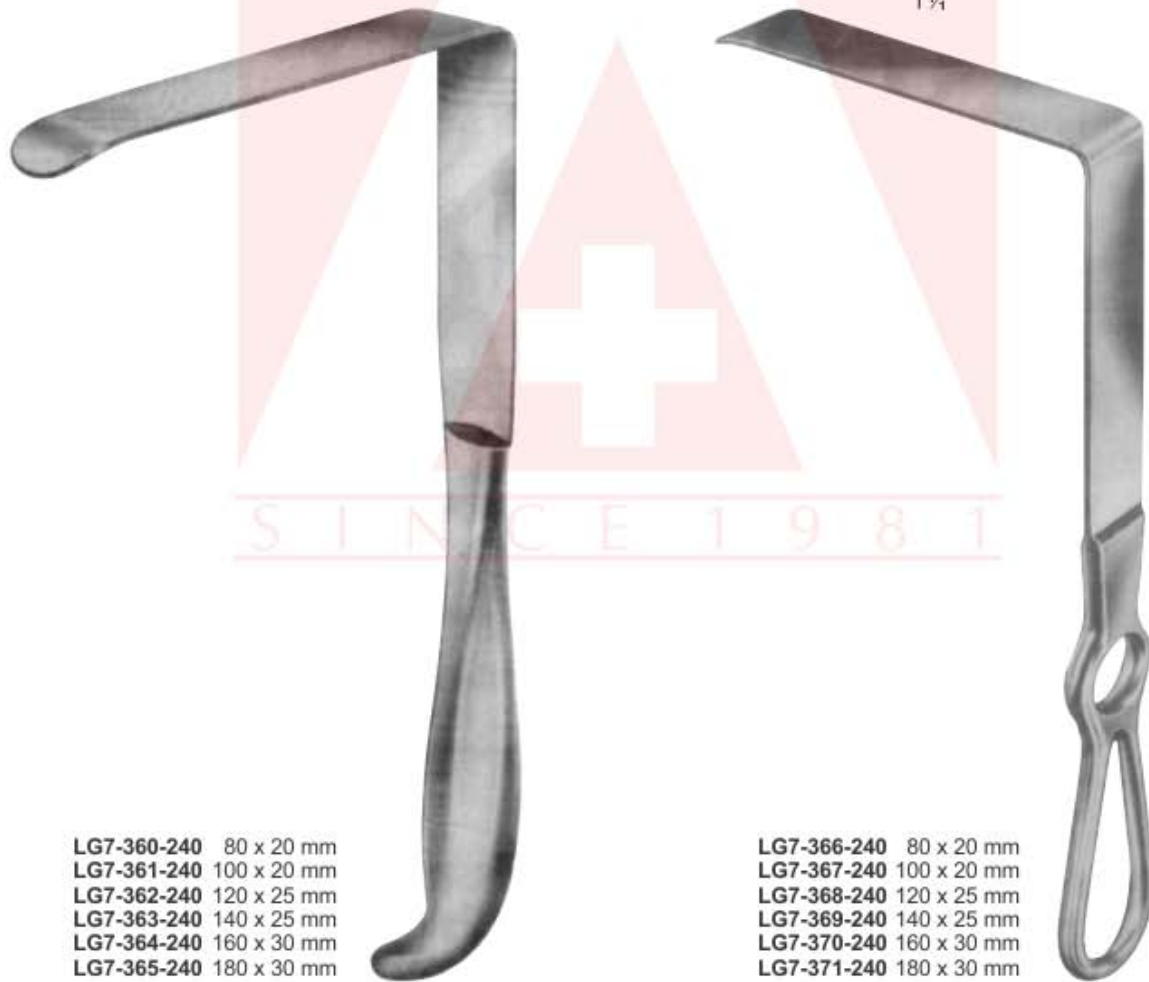
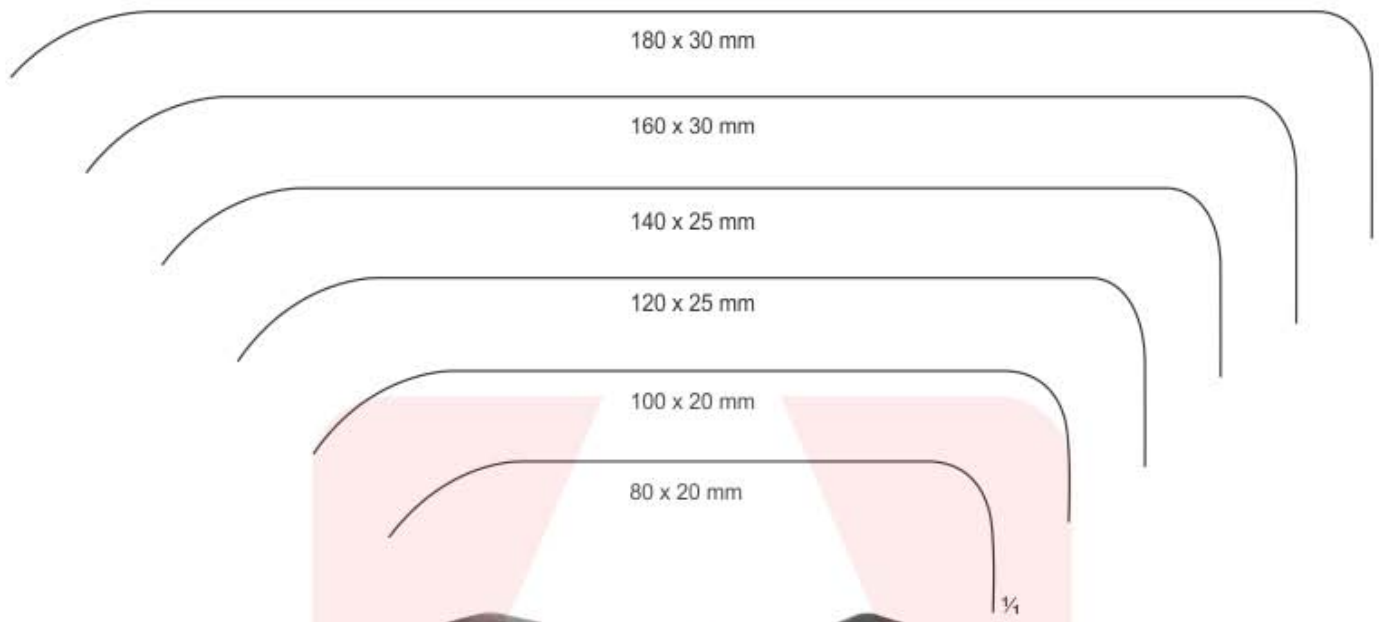

- LG7-360-240 80 x 20 mm
- LG7-361-240 100 x 20 mm
- LG7-362-240 120 x 25 mm
- LG7-363-240 140 x 25 mm
- LG7-364-240 160 x 30 mm
- LG7-365-240 180 x 30 mm

- LG7-366-240 80 x 20 mm
- LG7-367-240 100 x 20 mm
- LG7-368-240 120 x 25 mm
- LG7-369-240 140 x 25 mm
- LG7-370-240 160 x 30 mm
- LG7-371-240 180 x 30 mm

BRUNNER
24 cm, 9 1/2"

BRUNNER
24 cm, 9 1/2"



RETRACTORS

Wundhaken
Separadores

Ecarteurs
Divaricatori



22 mm

25 mm

25 mm

25 mm

19 mm

25 mm

LG7-373-215
21.5 cm, 8 ½"

DEAVER
LG7-372-180
18 cm, 7"

DEAVER
LG7-374-230
23 cm, 9"

DEAVER
LG7-375-300
30 cm, 11 ¼"

LG7-376-330
36 cm, 13 ½"
33 cm, 13"

38 mm

50 mm

75 mm

LG7-379-300
30 cm, 11 ¼"

LG7-380-300
30 cm, 11 ¼"

DEAVER
LG7-378-300
30 cm, 11 ¼"

S-SHAPED
LG7-381-210
21 cm, 8 ¼"
12 mm



RETRACTORS

Wundhaken
Separadores

Ecarteurs
Divaricatori

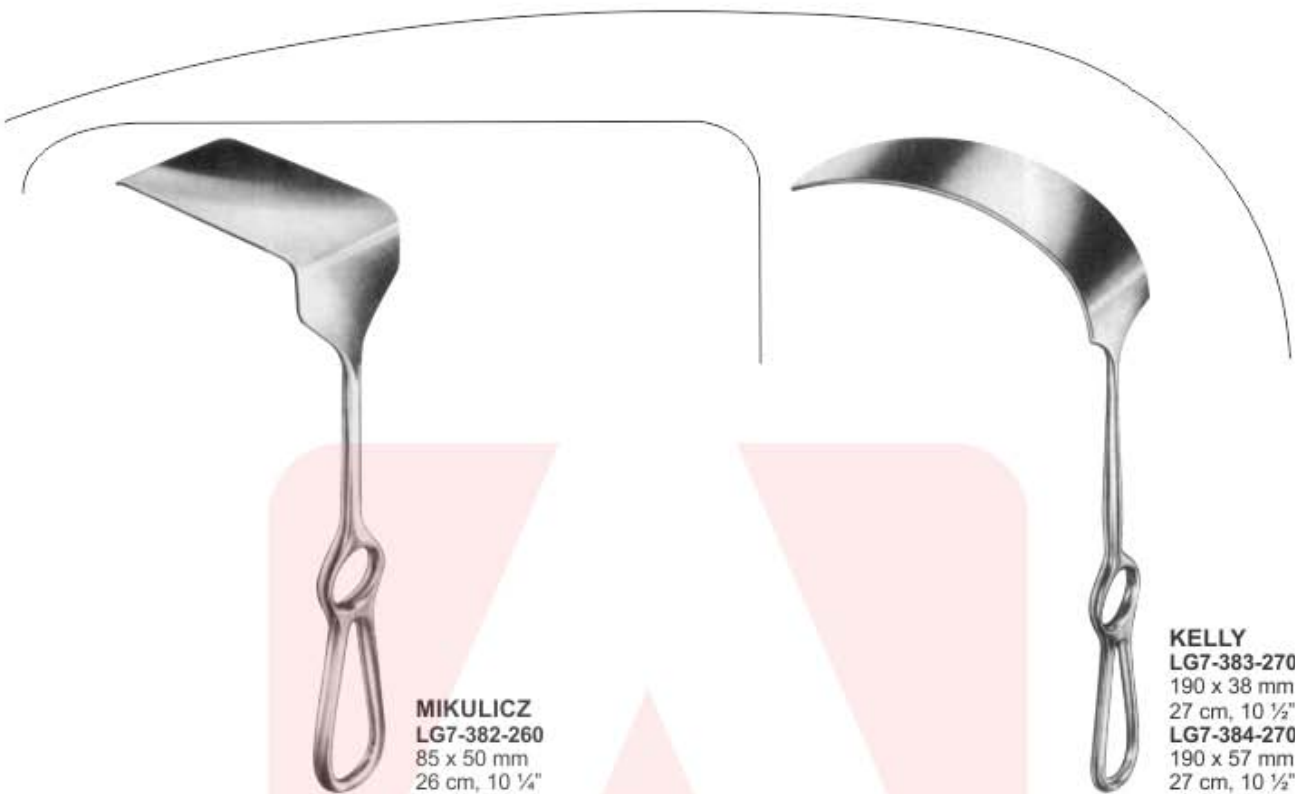

MIKULICZ
LG7-382-260
85 x 50 mm
26 cm, 10 ¼"

KELLY
LG7-383-270
190 x 38 mm
27 cm, 10 ½"
LG7-384-270
190 x 57 mm
27 cm, 10 ½"

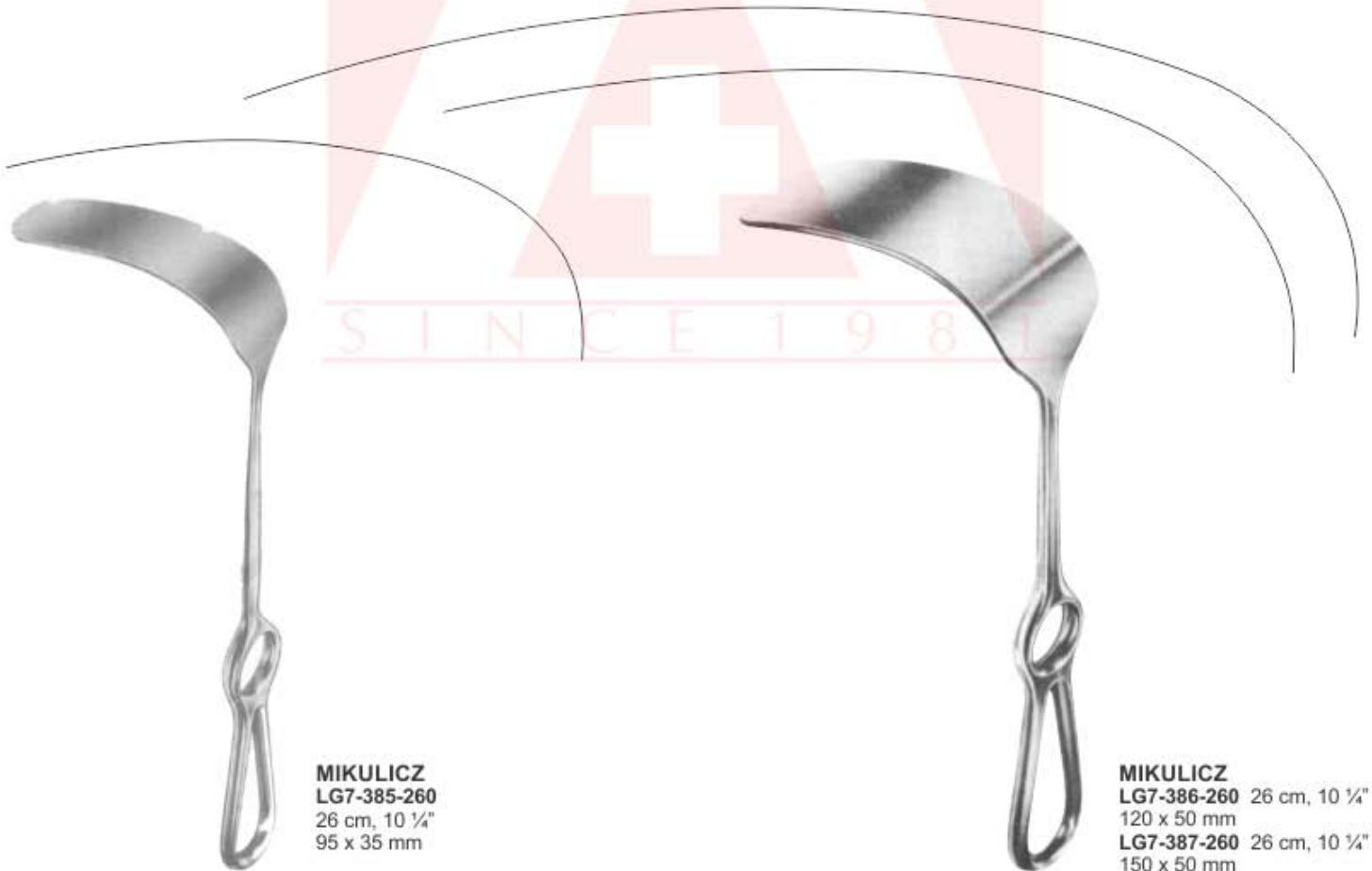

MIKULICZ
LG7-385-260
26 cm, 10 ¼"
95 x 35 mm

MIKULICZ
LG7-386-260 26 cm, 10 ¼"
120 x 50 mm
LG7-387-260 26 cm, 10 ¼"
150 x 50 mm



RETRACTORS

Wundhaken
Separadores

Ecarteurs
Divaricatori



**CHEEK AND LIP
RETRACTOR
(MOVABLE)**
LG7-388-190
19 cm, 7 1/2"



FRITSCH
LG7-389-240 35 x 40 mm
24 cm, 9 1/2"



TUFFIER
LG7-390-230 55 x 63 mm
23 cm, 9"



FRITSCH
LG7-391-240 24 cm, 9 1/2" 30 x 30 mm
LG7-392-240 24 cm, 9 1/2" 32 x 40 mm
LG7-393-240 24 cm, 9 1/2" 40 x 50 mm
LG7-394-240 24 cm, 9 1/2" 40 x 60 mm
LG7-395-240 24 cm, 9 1/2" 45 x 75 mm
LG7-396-240 24 cm, 9 1/2" 65 x 85 mm



DOYEN
LG7-397-250 50 x 85 mm
25 cm, 10"

S I N C E 1 9 8 1



RETRACTORS

Wundhaken
Separadores

Ecarteurs
Divaricatori



50 mm

DEAVER
LG7-398-305
30.5 cm 12"



75 mm

DEAVER
LG7-399-310
31.0 cm 12"

S I N C E 1 8 1



RETRACTORS

Wundhaken
Separadores

Ecarteurs
Divaricatori

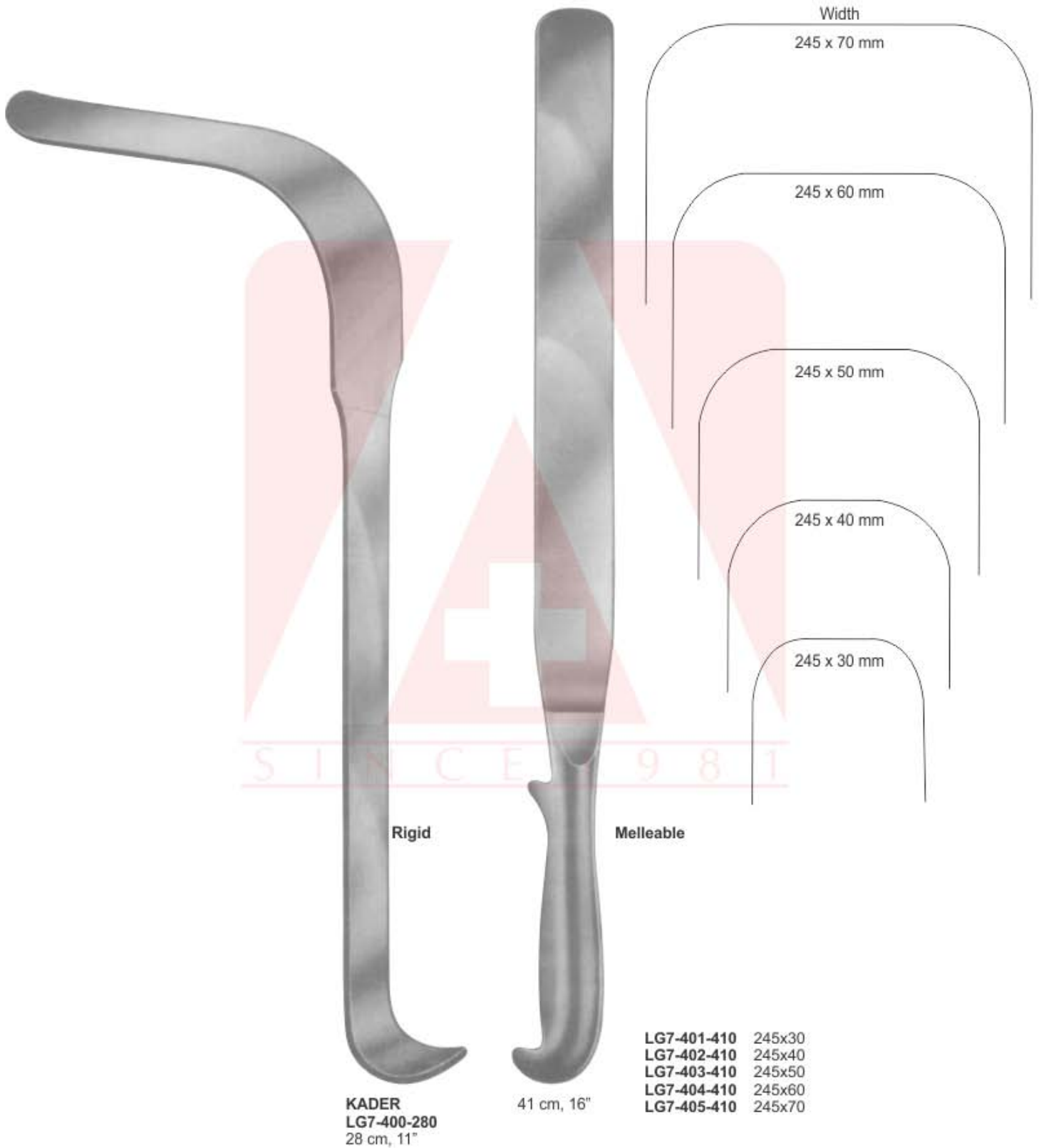

KADER
LG7-400-280
28 cm, 11"

41 cm, 16"

LG7-401-410 245x30
LG7-402-410 245x40
LG7-403-410 245x50
LG7-404-410 245x60
LG7-405-410 245x70



RETRACTORS

Wundhaken
Separadores

Ecarteurs
Divaricatori



LERICHE
LG7-406-310
31 cm, 12 ½"

LERICHE
LG7-407-330
33 cm, 13"

KUEMMEL
LG7-408-330
malleable
33 cm, 13"
46 mm

KUEMMEL
LG7-409-330
33 cm, 13"



RETRACTORS

Wundhaken
Separadores

Ecarteurs
Divaricatori

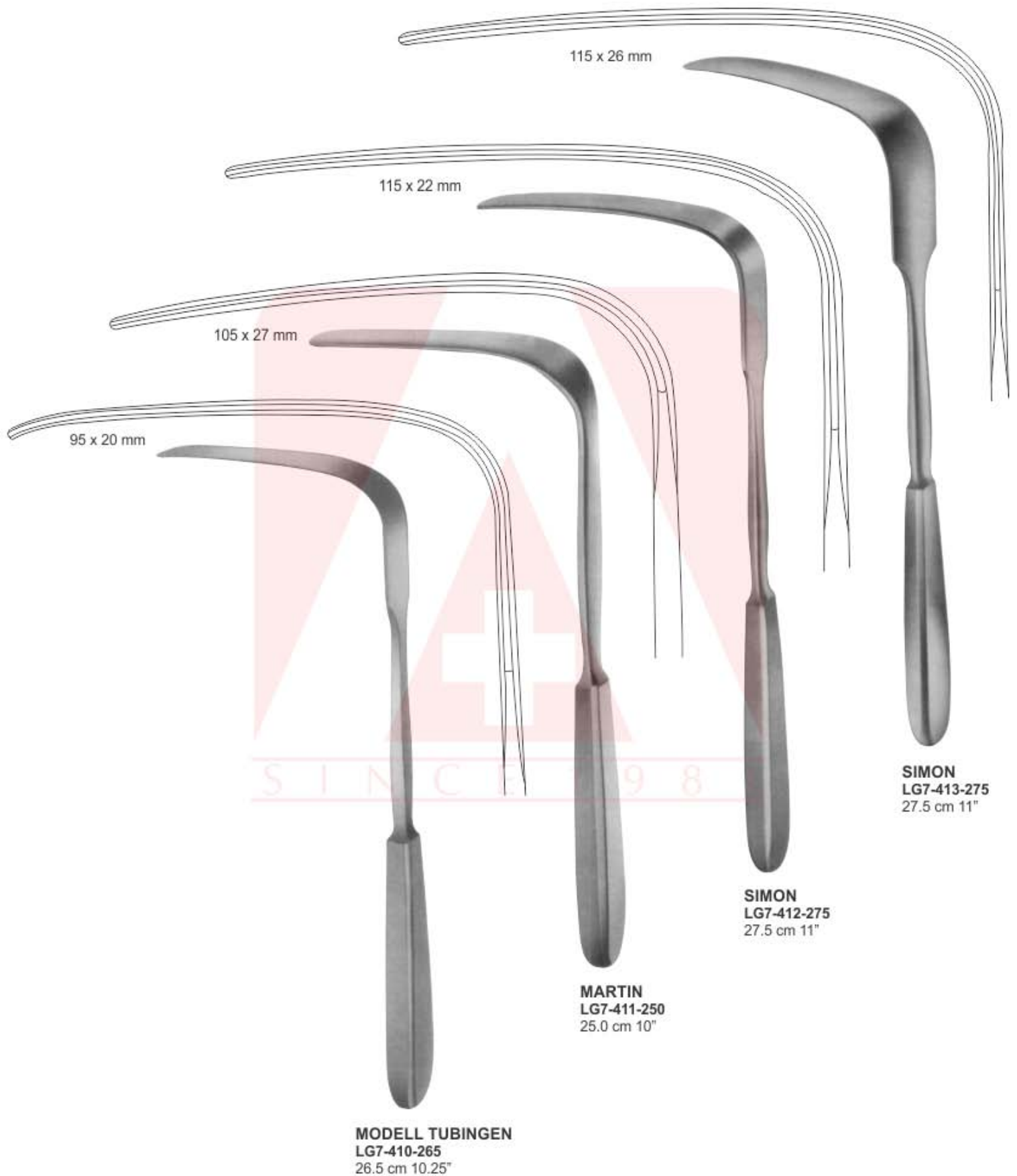

115 x 26 mm

115 x 22 mm

105 x 27 mm

95 x 20 mm

SIMON
LG7-413-275
27.5 cm 11"

SIMON
LG7-412-275
27.5 cm 11"

MARTIN
LG7-411-250
25.0 cm 10"

MODELL TUBINGEN
LG7-410-265
26.5 cm 10.25"



RETRACTORS, VEIN HOOKS

Wundhaken, Venenhäkchen
Separadores, Ganchitos Para venas

Ecarteurs, Ecarteurs sous
Divaricatori, Divaricatori per veni



MEYERDING
LG7-414-225 75 x 25mm
22.5 cm, 9"



LG7-415-225 50 x 16mm
22.5 cm, 9"



LG7-416-225 75 x 15mm
22.5 cm, 9"

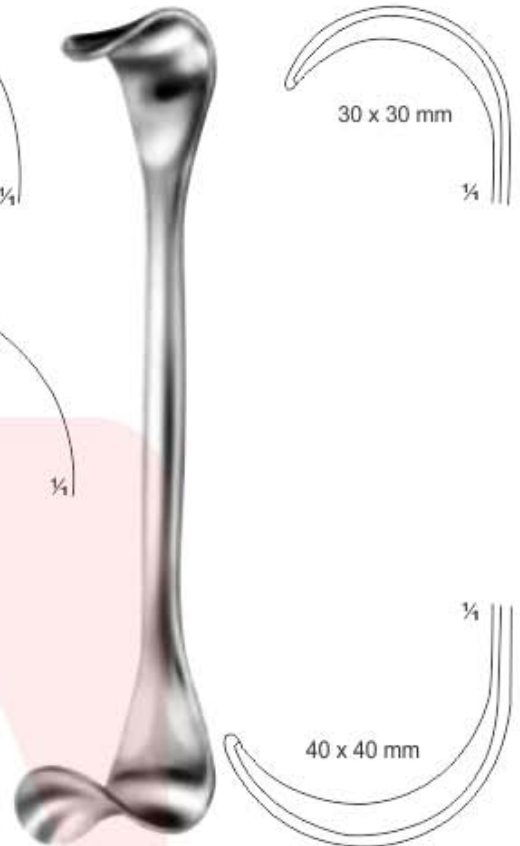

30 x 30 mm

40 x 40 mm

GOELET
LG7-417-190
19 cm 7 1/2"
Double Ended



KAYE-MILLARD
LG7-418-080
8 cm, 3 1/4"



RICHARDSON/KELLY

LG7-419-240 25 x 31mm
24 cm, 9 1/2"



LG7-420-240 19 x 51mm
24 cm, 9 1/2"



LG7-421-240 38 x 51mm
24 cm, 9 1/2"



LG7-422-240 64 x 76mm
24 cm, 9 1/2"



RETRACTORS

Wundhaken
Separadores

Ecarteurs
Divaricatori



ROSS
25.5 cm, 10"



LG7-423-255
Fig.01



LG7-424-255
Fig.02



LG7-425-255
Fig.03



LG7-426-255
Fig.04



LG7-427-255
Fig.05



$\frac{1}{4}$
LG7-428-255
Fig.06



**WEINBERG VAGOTOMY
RETRACTOR (JOE'S HOE)**
LG7-429-200
20 cm, 8"
Blade 102 x 165 mm wide



**TURNER-DOYEN
RETRACTORS**
LG7-430-235
Blade 140 x 60 mm wide
LG7-431-235
Blade 76 x 140 mm wide
LG7-432-235
Blade 165 x 76 mm wide
23.5 cm 9 1/2"

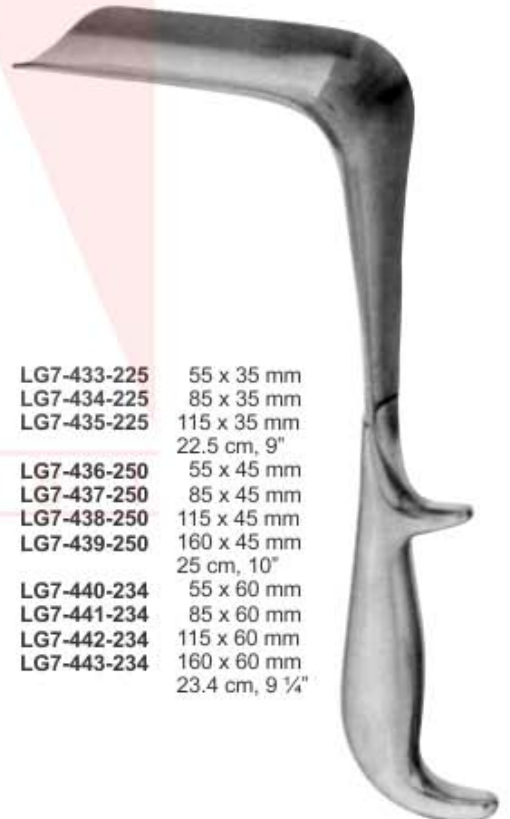

**DOYEN VAGINAL
RETRACTORS**

- LG7-433-225** 55 x 35 mm
- LG7-434-225** 85 x 35 mm
- LG7-435-225** 115 x 35 mm
22.5 cm, 9"
- LG7-436-250** 55 x 45 mm
- LG7-437-250** 85 x 45 mm
- LG7-438-250** 115 x 45 mm
- LG7-439-250** 160 x 45 mm
25 cm, 10"
- LG7-440-234** 55 x 60 mm
- LG7-441-234** 85 x 60 mm
- LG7-442-234** 115 x 60 mm
- LG7-443-234** 160 x 60 mm
23.4 cm, 9 1/4"



RETRACTORS

Wundhaken
Separadores

Ecarteurs
Divaricatori

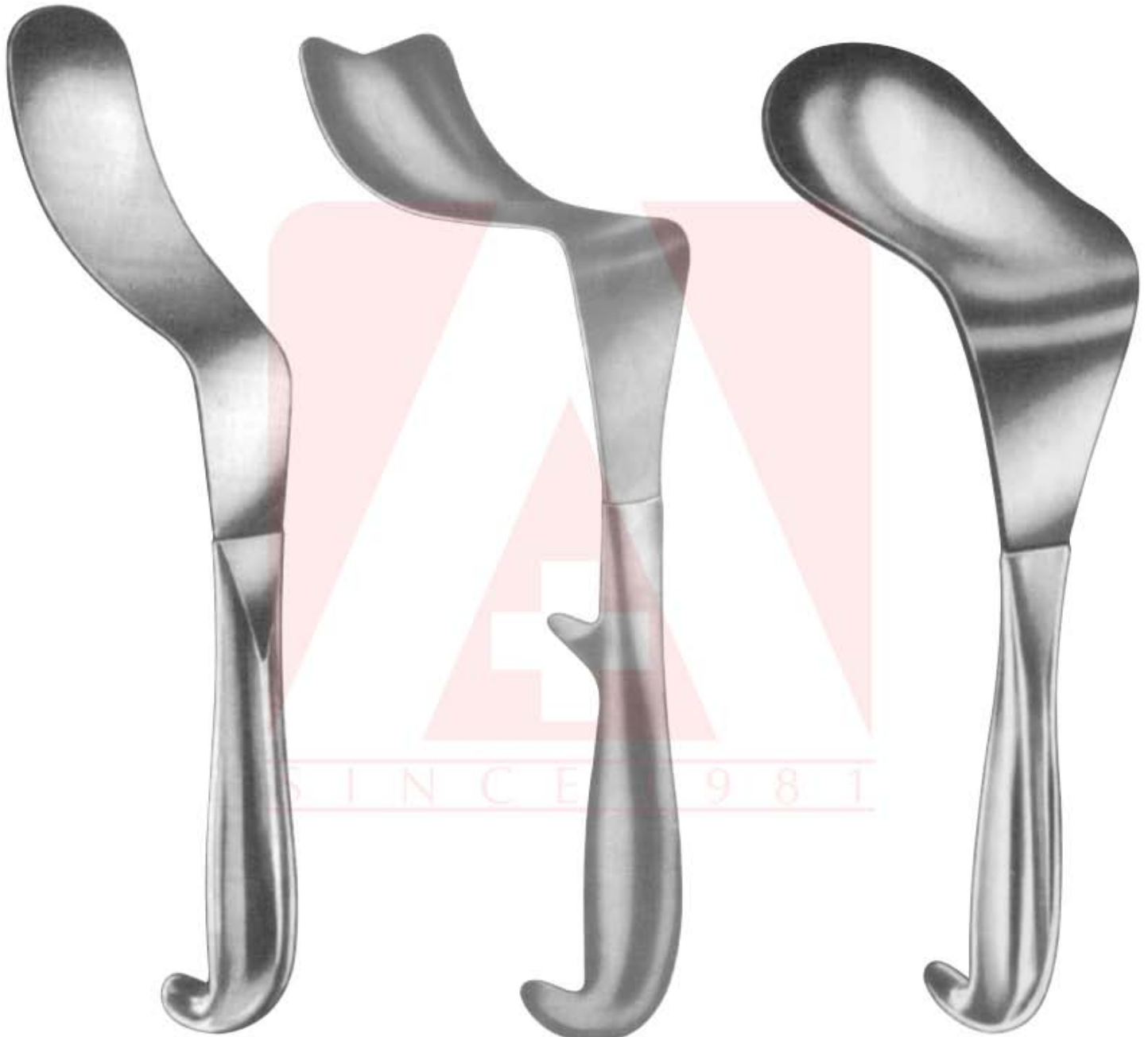

LEGUEU
LG7-444-270
35 x 90 mm
27 cm 10 ½"
Bladder Spatula

KOCHER
LG7-445-260
56 x 90 mm
26 cm 10 ¼"

KOCHER
LG7-446-260
65 x 90 mm
26 cm 10 ¼"



RETRACTORS

Wundhaken
Separadores

Ecarteurs
Divaricatori

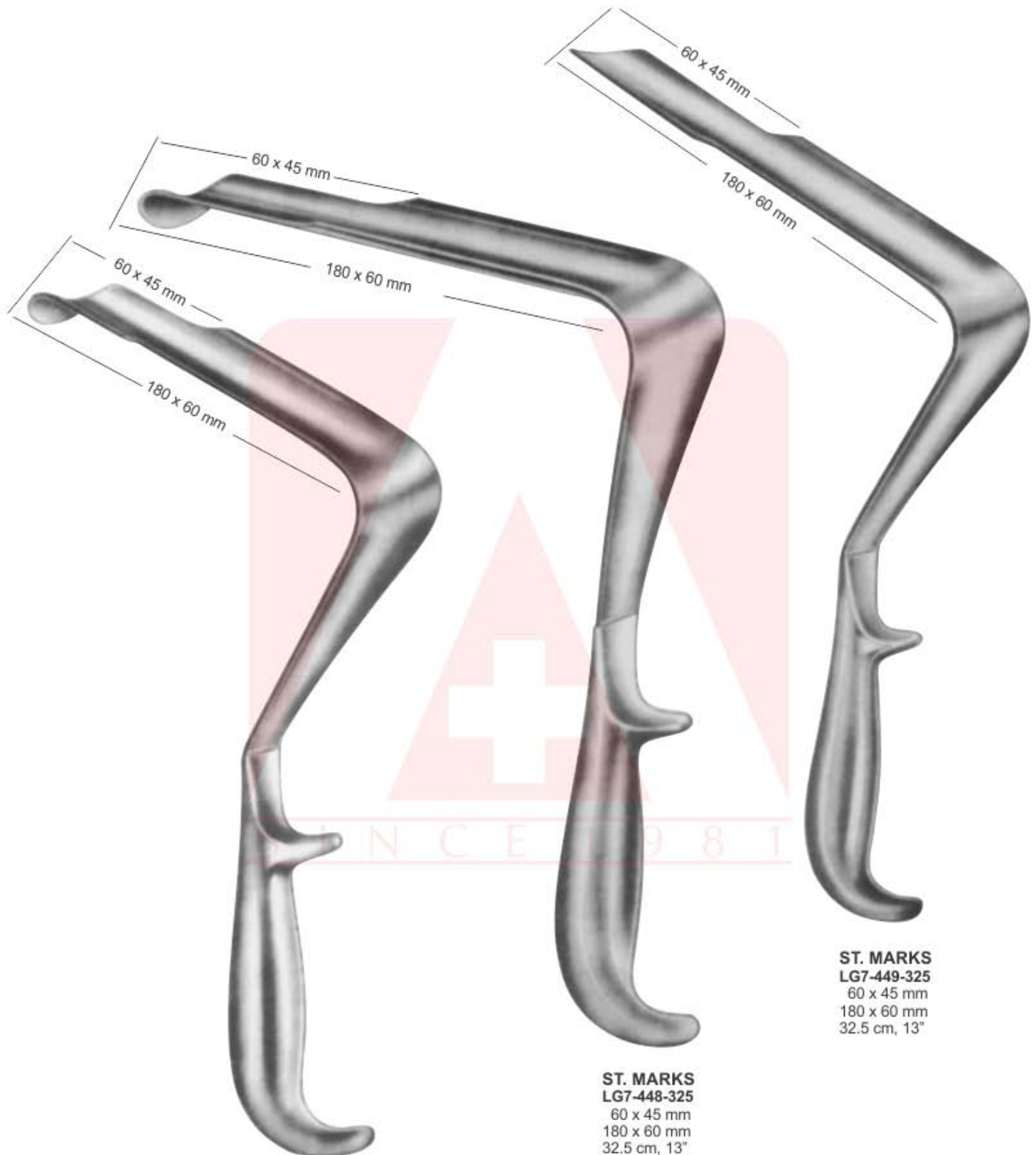

ST. MARKS
LG7-447-290
60 x 45 mm
180 x 60 mm
29 cm, 11 1/2"

ST. MARKS
LG7-448-325
60 x 45 mm
180 x 60 mm
32.5 cm, 13"

ST. MARKS
LG7-449-325
60 x 45 mm
180 x 60 mm
32.5 cm, 13"



RETRACTORS

Wundhaken
Separadores

Ecarteurs
Divaricatori



KOERTE
LG7-450-280
120 x 45 mm
28 cm 11"



KUEMME
LG7-451-280
100 x 45 mm
28 cm, 11"



YOUNG
LG7-452-220
22 cm, 8 3/4"



YOUNG
LG7-453-215
21.5 cm, 8 1/2"
Prostatic Retractors



YOUNG
LG7-454-215
21.5 cm, 8 1/2"

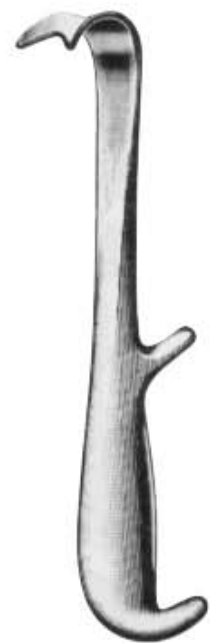

YOUNG
LG7-455-220
22 cm, 8 3/4"

S I N C E 1 9 8 1



RETRACTORS

Wundhaken
Separadores

Ecarteurs
Divaricatori



KELLY RETRACTOR
LG7-456-240 24 cm 9 1/2"
50 x 40 mm wide

LG7-457-240 24 cm 9 1/2"
65 x 50 mm wide

LG7-458-250 25 cm 10"
75 x 65 mm wide

LG7-459-250 25 cm 10"
90 x 75 mm wide



KELLY
LG7-460-250
55 x 50 mm
25 cm, 10"



LG7-461-250
64 x 43 mm

LG7-462-250
39 x 30 mm

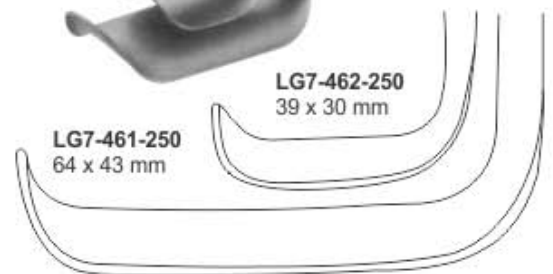

RICHARDSON-EASTMAN
LG7-461-250
25.0 cm 10", Set of 2 piece



RETRACTORS

Wundhaken
Separadores

Ecarteurs
Divaricatori



BUCKLEY
LG7-463-060
6 cm, 2 1/2"

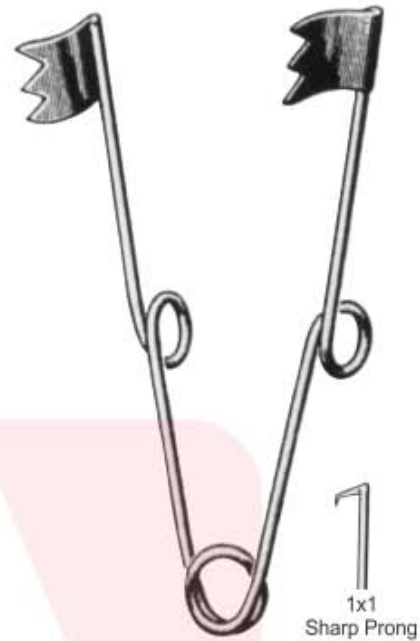

**WIRE RETAINING
RETRACTOR**
LG7-464-085 8.5 cm, 3 1/2" 3 x 3 Prong
LG7-465-085 8.5 cm, 3 1/2" 1 x 1 Prong Sharp



ALM
LG7-466-070 7 cm, 2 3/4"
4 x 4 teeth sharp/blunt
LG7-467-100 10 cm, 4"
4 x 4 teeth sharp/blunt



JANSEN
LG7-468-100 10 cm, 4"
Sharp 3:3
LG7-469-100 10 cm, 4"
Blunt 3:3



RETRACTORS

Wundhaken
Separadores

Ecarteurs
Divaricatori



SCALP-CONTOUR
LG7-470-140 Sharp
LG7-471-140 Blunt
14 cm, 5 1/2"



HENLEY

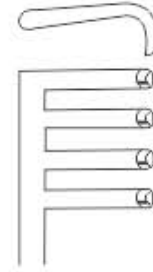

LG7-472-160
16 cm, 6 1/4"
3 : 4 mm
blunt

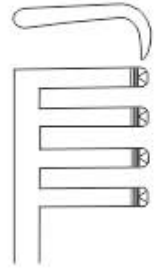

LG7-473-160
16 cm, 6 1/4"
3 : 4 mm
sharp



**HORIZONTAL
RETRACTOR**
LG7-474-330
33 cm, 13"



MOLLISON
LG7-475-150
15 cm, 6"
sharp



RETRACTORS

Wundhaken
Separadores

Ecarteurs
Divaricatori



DARLING
LG7-476-180 18 cm, 7"
40 x 76/25 x 54 mm
LG7-477-180 18 cm, 7"
25 x 64/40 x 76 mm
Laminectomy Retractor
1 blade toothed

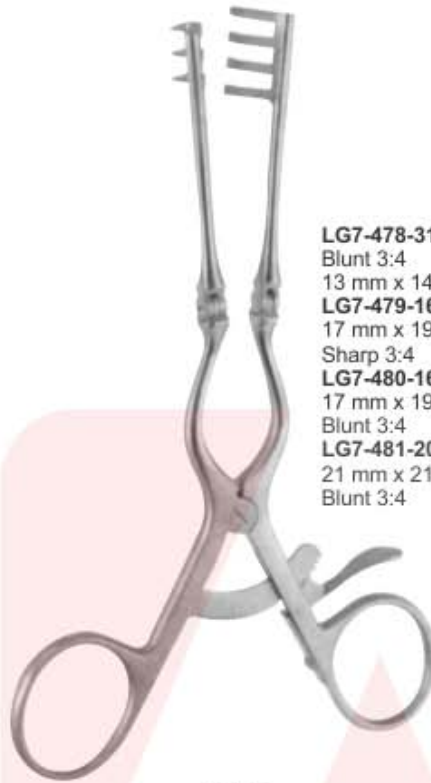

CONE

LG7-478-310 31 cm, 12"
Blunt 3:4
13 mm x 14.5 mm
LG7-479-165 16.5 cm, 6 1/2"
17 mm x 19 mm
Sharp 3:4
LG7-480-165 16.5 cm, 6 1/2"
17 mm x 19 mm
Blunt 3:4
LG7-481-200 20 cm, 8"
21 mm x 210 mm
Blunt 3:4

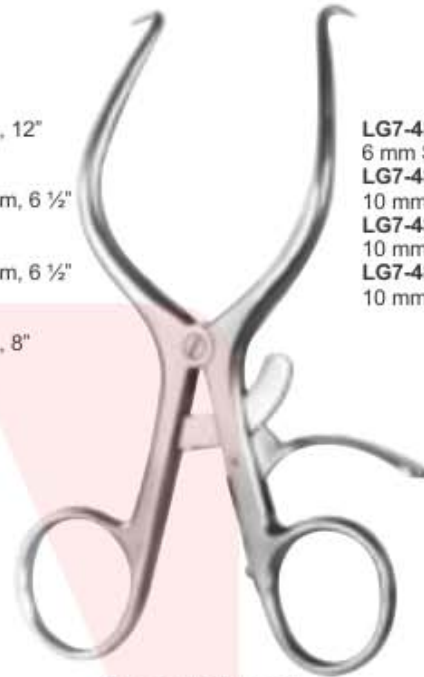

GELPI-LOKTITE

LG7-482-090 9 cm, 3 1/2"
6 mm Sharp
LG7-483-110 11 cm, 4 1/4 "
10 mm Sharp
LG7-484-140 14 cm, 5 1/2"
10 mm Sharp
LG7-485-190 19 cm, 7 1/2"
10 mm Sharp



GELPI-LOKTITE
LG7-486-180
18 cm, 7"



MARKHAM/MEYERDING
LG7-487-180
18 cm, 7" Blade 55 x 25 mm Left
LG7-488-180
18 cm, 7" Blade 55 x 25 mm Right



MILLIGAN
LG7-489-130
18.5 mm x 20 mm
Blunt, 3:3
13 cm, 5"

S I N C E 1 9 8 1



RETRACTORS

Wundhaken
Separadores

Ecarteurs
Divaricatori



WEITLANER
Sharp
LG7-490-165
16.5 cm 6.5"

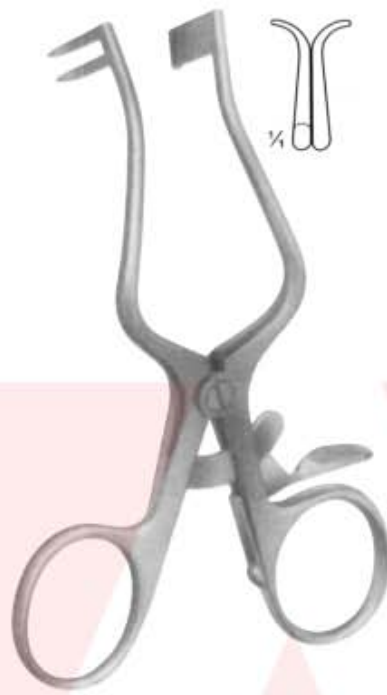

PLESTER
Blunt
LG7-491-110
11.0 cm 4.25"

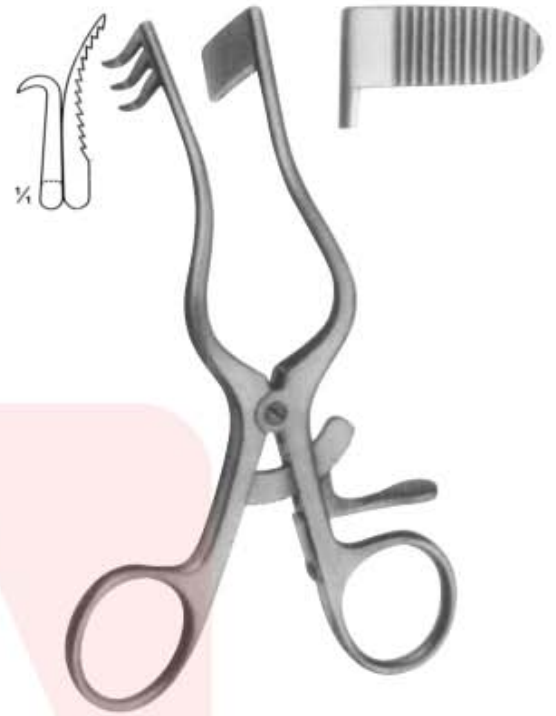

PERKINS
LG7-492-130
13.0 cm 5.25"



GELPI
Vaginal Retractor
LG7-493-135
13.5 cm, 5"



GELPI
Skin- and Vaginal Retractor
LG7-494-175
17.5 cm, 7"



DE BAKEY
Femur Retractor
LG7-495-145
14.5 cm, 4 1/2"

S I N C E 1 9 8 1



RETRACTORS

Wundhaken
Separadores

Ecarteurs
Divaricatori

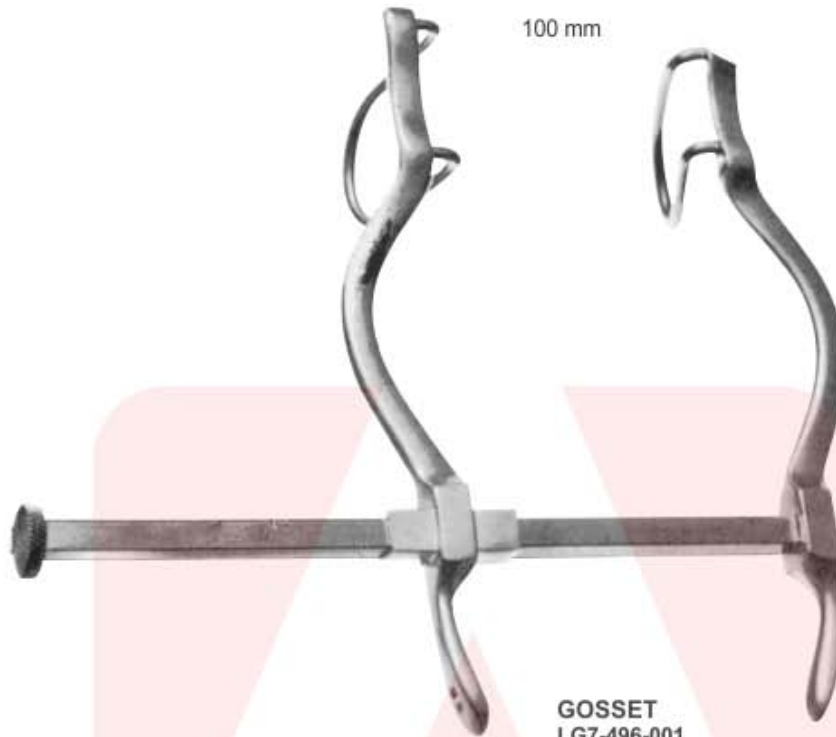

100 mm

GOSSET
LG7-496-001
Center Blades 40 x 30 mm

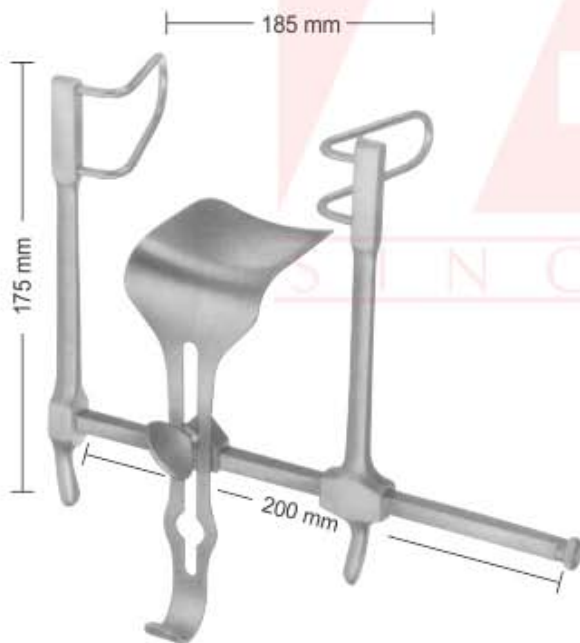

GOSSET
LG7-497-001
Lateral Blades 58 mm deep
Center blade 59 x 57 mm

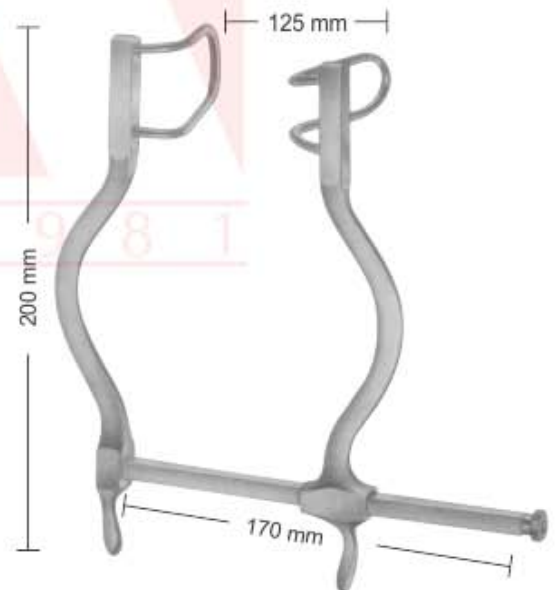

GOSSET
LG7-498-001
Blades: 55mm deep



RETRACTORS

Wundhaken
Separadores

Ecarteurs
Divaricatori

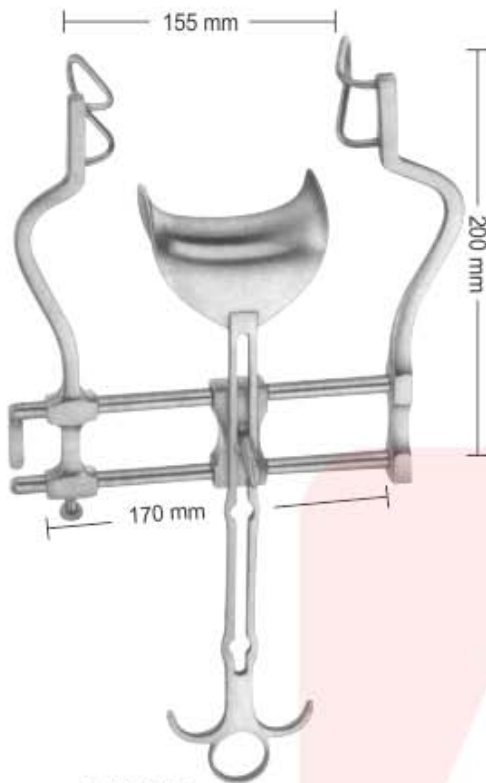

**BALFOUR
LG7-499-001**
Lateral blades 60 mm deep
Center blade 47 x 80 mm

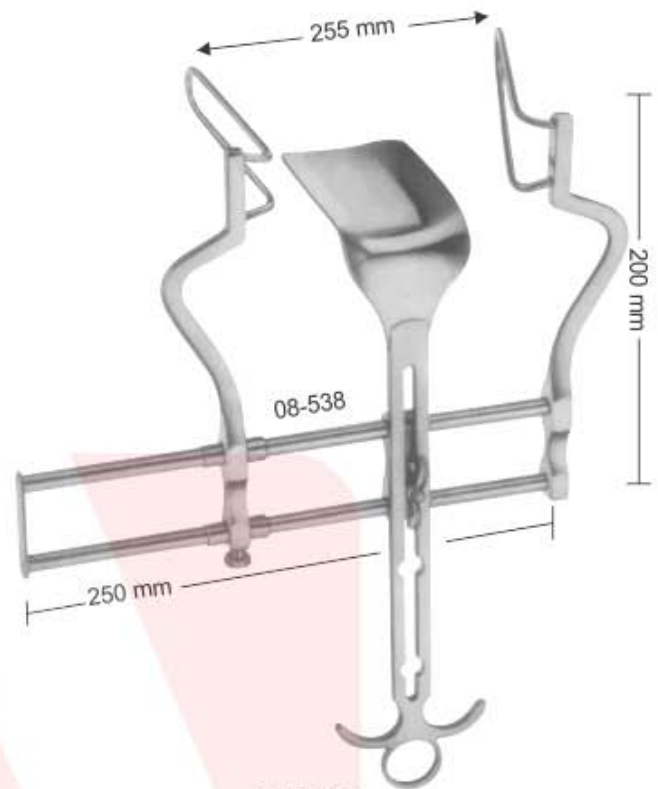

**BALFOUR
LG7-500-001**
Lateral blades 105 mm deep
Center blade 107 x 59 mm



LG7-501-001
Center blade only
54 x 80 mm

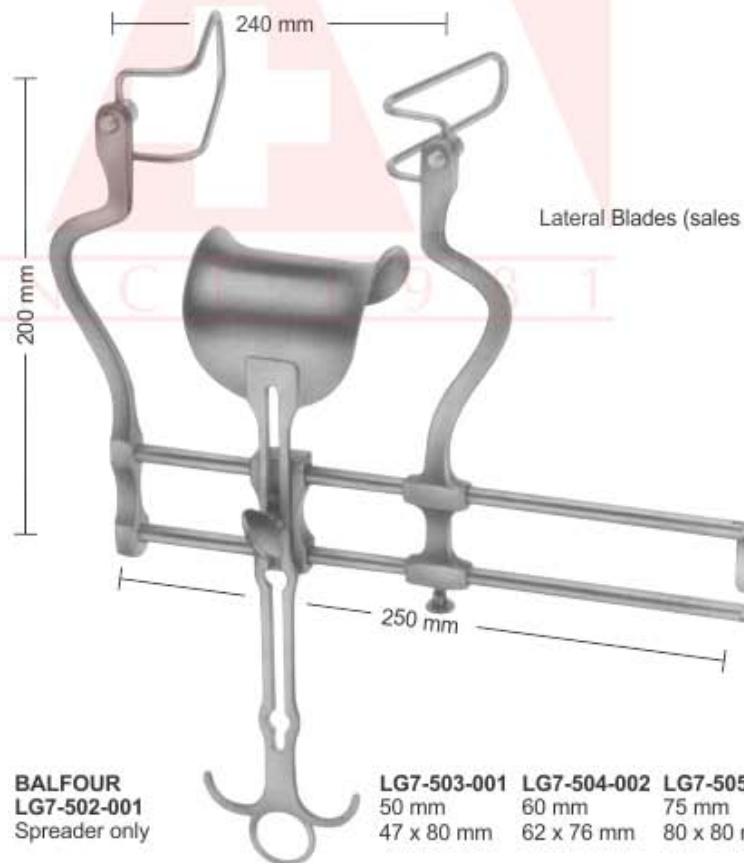

**BALFOUR
LG7-502-001**
Spreader only

Lateral Blades (sales unit of blades in pairs)

| | | | |
|---|---|---|---|
| LG7-503-001 50 mm 47 x 80 mm | LG7-504-002 60 mm 62 x 76 mm | LG7-505-003 75 mm 80 x 80 mm | LG7-506-004 90 mm 80 x 80 mm |
|---|---|---|---|



RETRACTORS

Wundhaken
Separadores

Ecarteurs
Divaricatori



O'SULLIVAN/O'CONNOR
LG7-507-001 (Set includes frame & 3 blades)
LG7-508-002 Frame Only (not pictured)



LG7-509-001
Single Retractor Blade
110 x 70 mm



LG7-510-002
Set of 2 Retractor Blade
80 x 45 mm



LG7-511-001
Center Blade
45 x 80 mm
70 x 85 mm



LG7-512-001
Center Blade
100 x 60 mm

Sizes of These Blades to
Same as about Blades.



COLLIN
LG7-513-250 Complete
LG7-514-001 Spreader only
LG7-515-002 Blades 55 x 25 mm
LG7-516-003 Blades 80 x 25 mm
LG7-517-004 Center Blade
115 x 45 mm



RETRACTORS

Wundhaken
Separadores

Ecarteurs
Divaricatori



LEGUEU
LG7-518-170
17 cm, 6 3/4"



BABY-COLLIN
LG7-519-001
with 2 pair of blades

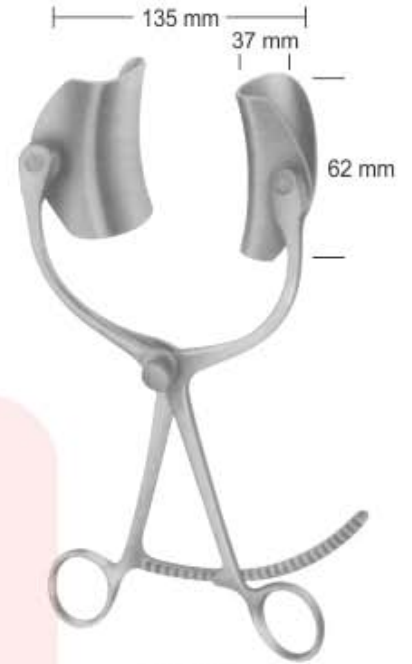

COLLIN
LG7-520-001
complete

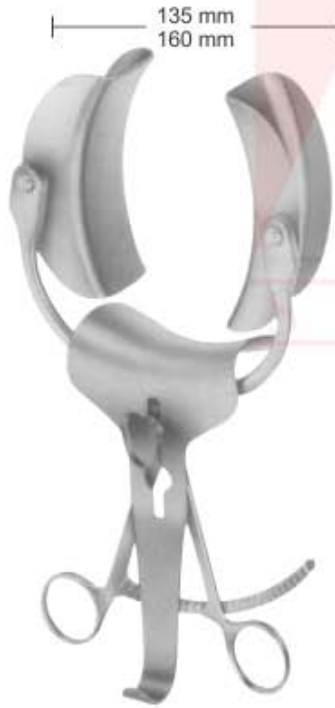

COLLIN
LG7-521-00
Spreader Only

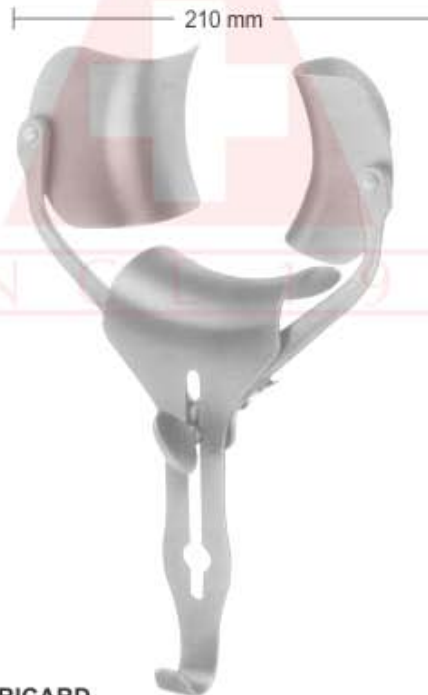

RICARD
LG7-528-001 Complete
LG7-529-002 Spreader only



HOLZBACH
LG7-534-001 Complete
LG7-535-002 Spreader only
LG7-536-003 Lateral blade 59x80mm
LG7-537-004 Center blade 74x82mm

| | | | | | | |
|---------------|-------------|-------------|-------------|---------------|-------------|-------------|
| Lateral blade | LG7-522-001 | LG7-524-003 | LG7-526-005 | Lateral blade | LG7-530-003 | LG7-532-005 |
| | 37x62mm | 37x80mm | 37x98mm | | 58x80mm | 72x84mm |
| Center blade | LG7-523-002 | LG7-525-004 | LG7-527-006 | Center blade | LG7-531-004 | LG7-533-006 |
| | 54x55mm | 54x67mm | 52x76mm | | 54x70mm | 72x90mm |



RETRACTORS

Wundhaken
Separadores

Ecarteurs
Divaricatori

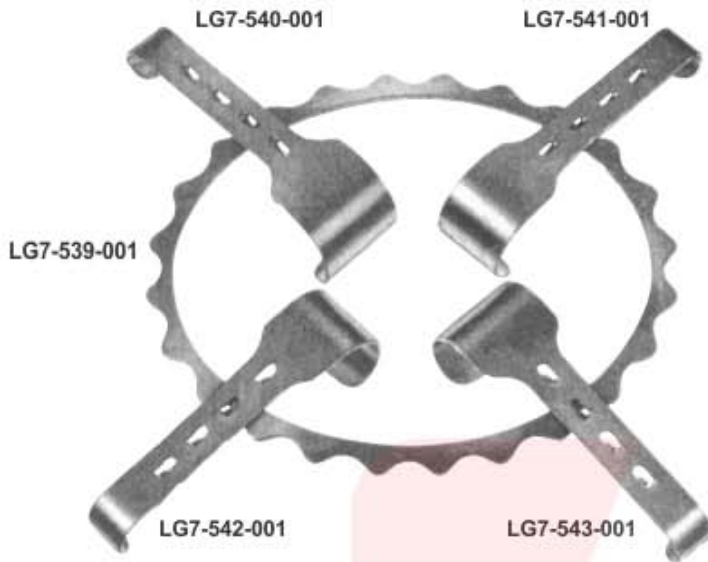

ABDOMINAL RETRACTORS
for new-born and children

DENIS-BROWNE

LG7-538-001 Complete with 4 blades

LG7-539-001 Frame 190 x 160 mm

LG7-540-001 2 blades only 40 x 30 mm

LG7-541-001 2 blades only 40 x 40 mm

LG7-542-001
Blades only 20 x 30 mm



LG7-543-001
Blades only 20 x 40 mm



ABDOMINAL RETRACTORS
well suitable for gynaecologists

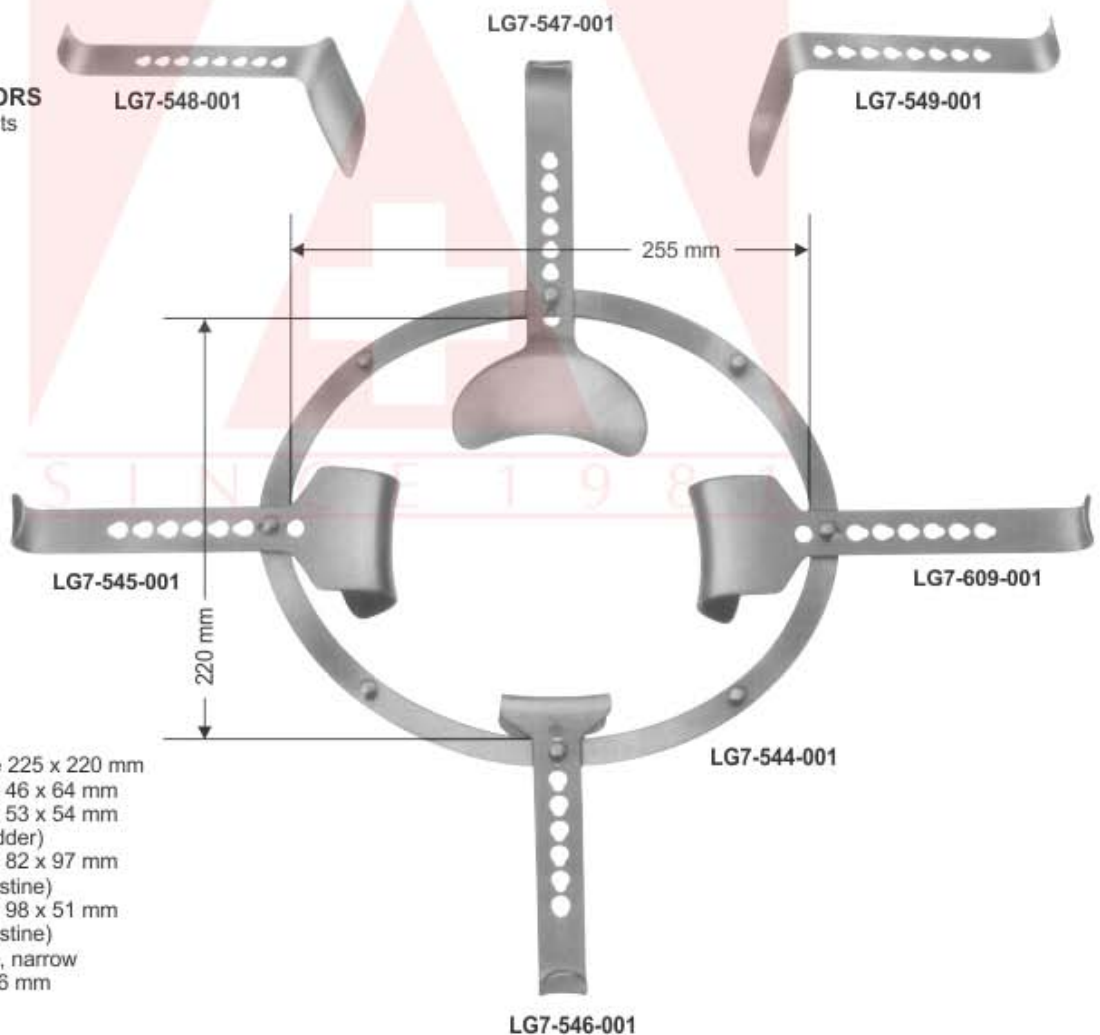

SEMM

consisting of:

LG7-544-001 1 frame 225 x 220 mm

LG7-545-001 2 blade 46 x 64 mm

LG7-546-001 1 blade 53 x 54 mm
(for bladder)

LG7-547-001 1 blade 82 x 97 mm
(for intestine)

LG7-548-001 1 blade 98 x 51 mm
(for intestine)

LG7-549-001 1 blade, narrow
107 x 36 mm



RETRACTORS

Wundhaken
Separadores

Ecarteurs
Divaricatori

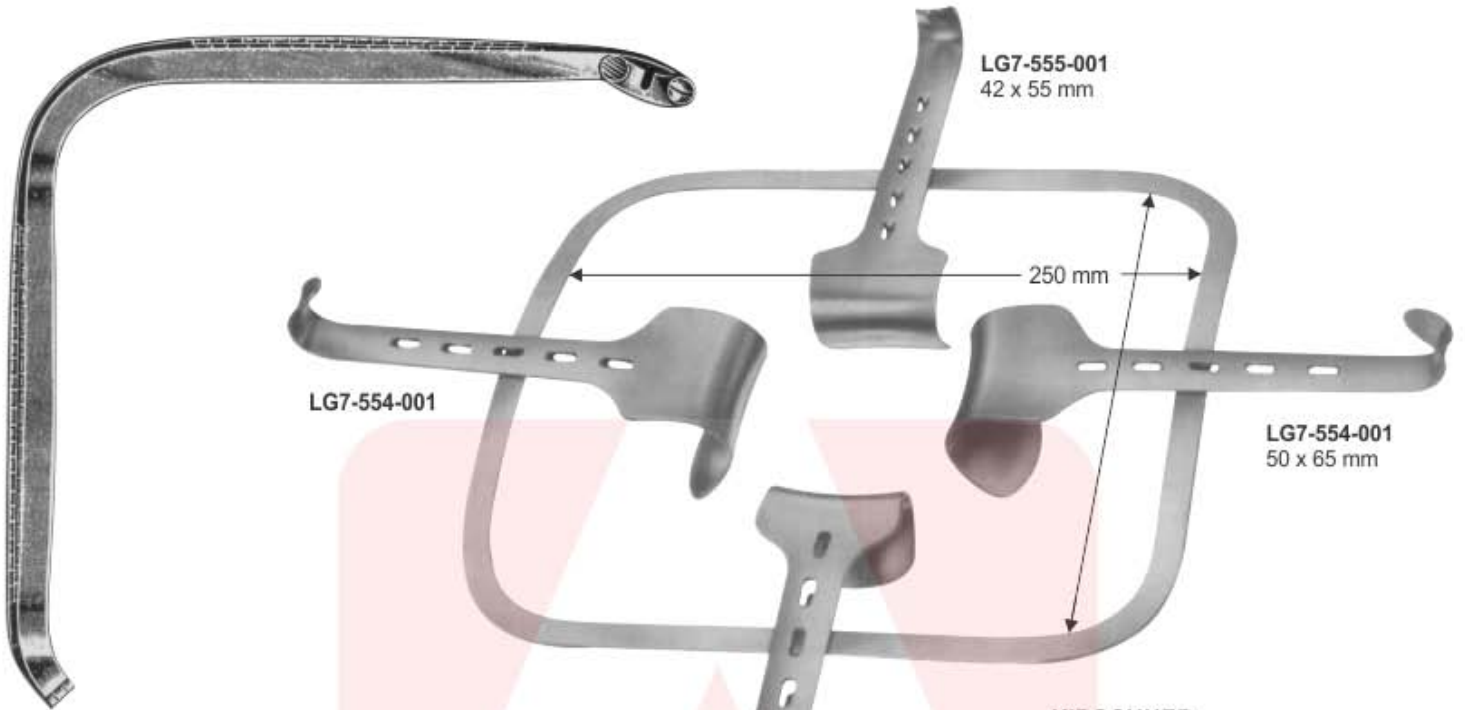

KIRSCHNER
LG7-550-001
with folding frame &
2 blades of each **LG7-554-001** &
LG7-555-001

KIRSCHNER
LG7-551-001
with vaulted fixed frame &
2 blades of each **LG7-554-001** &
LG7-555-001

LG7-552-001
300 x 380 mm
Frame only, over-sized

LG7-553-001
320 x 300 mm
Frame only

Additional valves for corpulent persons

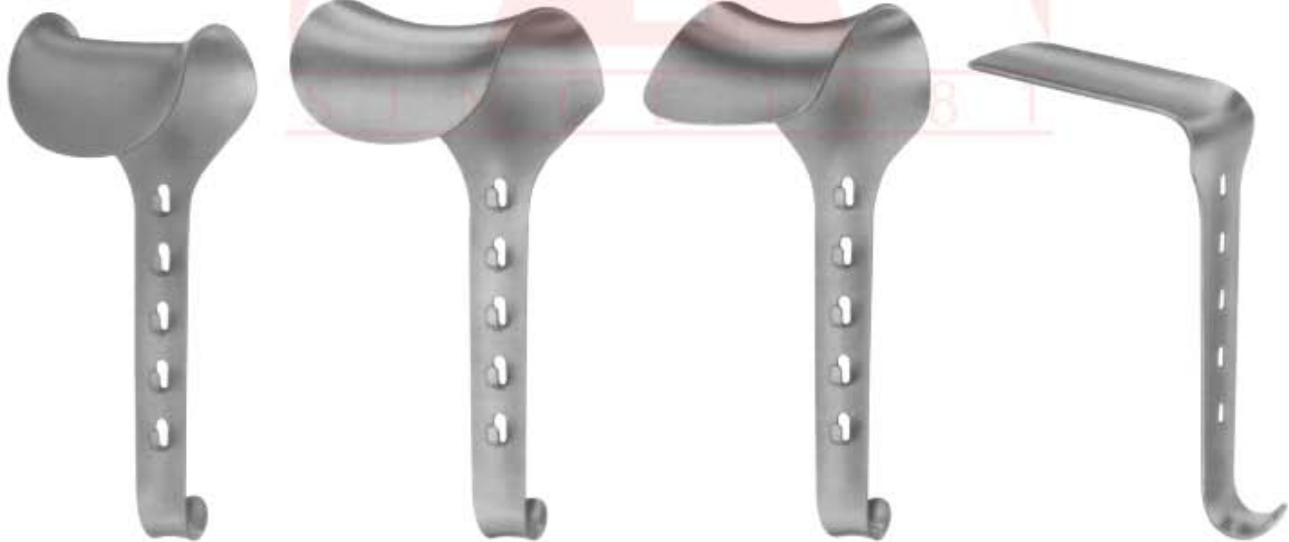

KIRSCHNER
LG7-556-001
64 x 80 mm

KIRSCHNER-BALFOUR
LG7-557-001
80 x 82 mm

KIRSCHNER
LG7-558-001 90 x 69 mm
LG7-559-002 92 x 95 mm
LG7-560-003 78 x 58 mm

KIRSCHNER
LG7-561-001 108 x 42 mm
LG7-562-002 91 x 55 mm
LG7-563-003 121 x 55 mm



GENERAL INSTRUMENTS

- PROBES
- APPLICATORS
- DIRECTORS

- NAIL NIPPERS
- SUTURE INSTRUMENTS
- REVERDIN NEEDLES
- LIGATURE NEEDLES

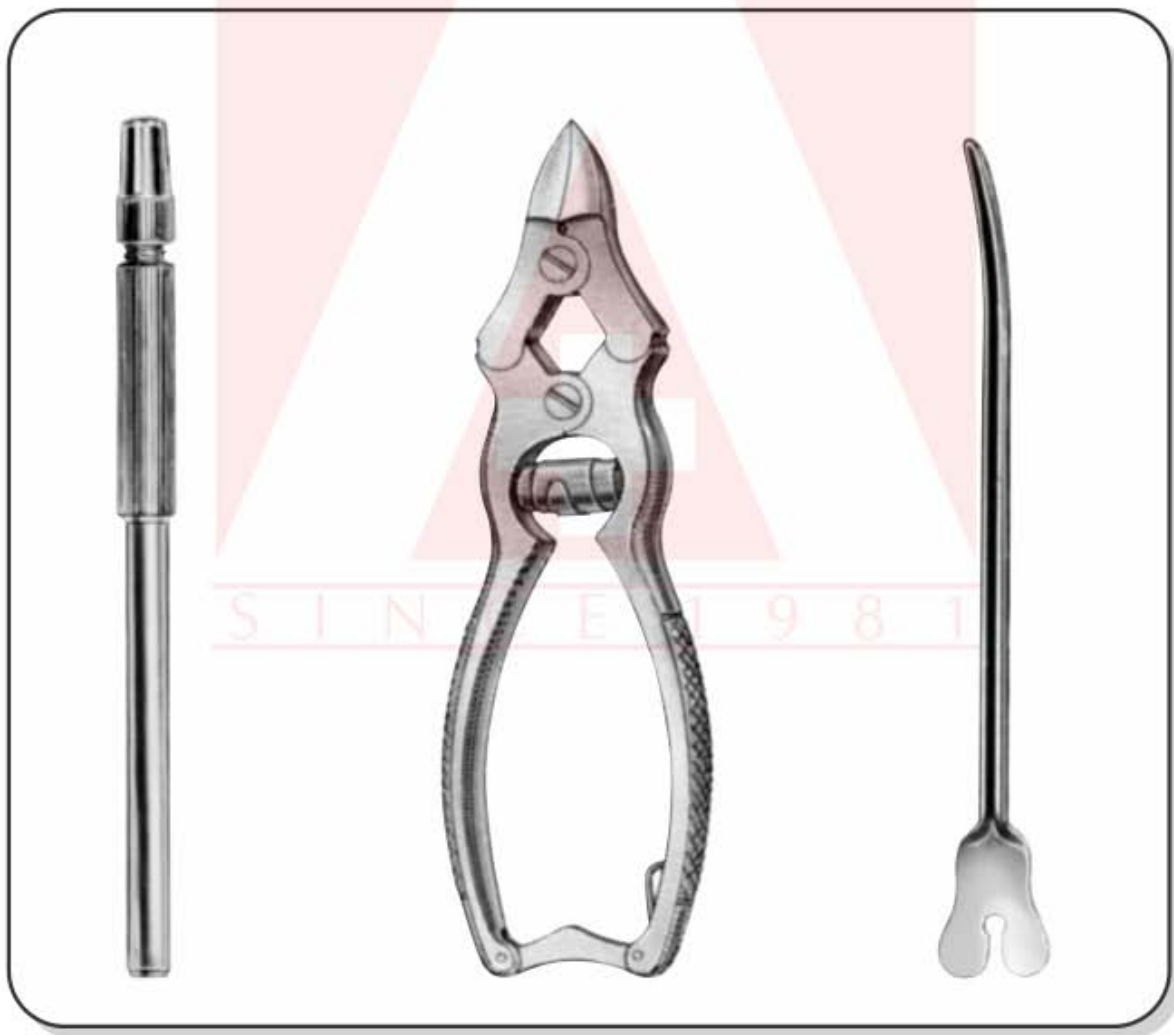



GENERAL INSTRUMENTS

Allgemeines Instrumentarium
Instrumental general

Instrumentation générale
Strumentario generale

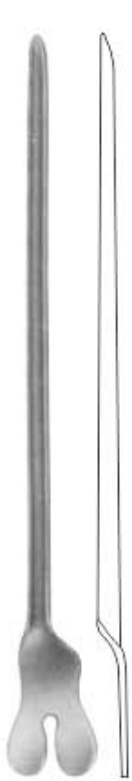

DIRECTORS

LG8-001-130 13 cm, 5"
LG8-002-145 14.5 cm, 5 3/4"
LG8-003-116 16 cm, 6"

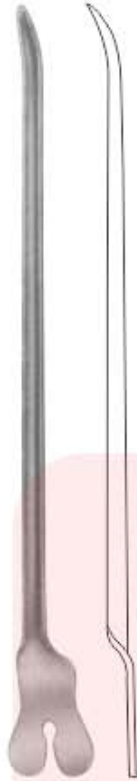

DOYEN

LG8-004-145
14.5 cm, 5 3/4"



NELATON

LG8-005-160
16 cm, 6"



LG8-006-140

14 cm, 5 1/2"
Director with tip
Diam. of tip 3.3 mm

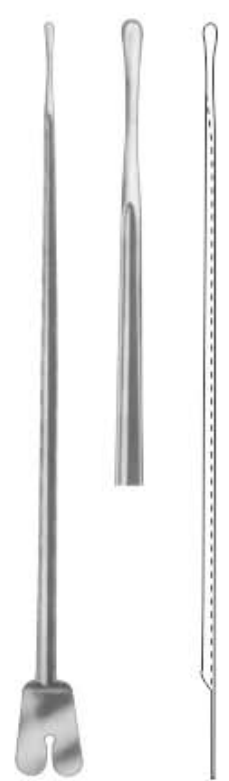

BRODIE

LG8-007-200
20 cm, 8"
Director with tip
Diam. of tip 3.5 mm



LOCKHART-MUMMERY

LG8-008-165
16.5 cm, 6 1/2"



SPATULA

LG8-009-145
14.5 cm, 5 3/4"



SPATULA

LG8-010-145
14.5 cm, 5 3/4"



MODELL PICCOLO

LG8-011-110
11.0 cm, 4 1/4"
Round Serrated

S I N C E 1 8 8 1



GENERAL INSTRUMENTS

Allgemeines Instrumentarium
Instrumental general

Instrumentation générale
Strumentario generale



LG8-012-145 14.5 cm, 5 ¾"
LG8-013-160 16.0 cm, 6 ¼"
LG8-014-200 20.0 cm, 8"
probes with eye



LG8-015-145
14.5 cm, 5 ¾"
Myrtle leaf probe



LG8-016-130 13.0 cm, 5"
LG8-017-145 14.5 cm, 5 ¾"
LG8-018-160 16.0 cm, 6 ¼"
LG8-019-185 18.5 cm, 7"
LG8-020-200 20.0 cm, 8"



LG8-021-001
probe



LG8-022-190
19.0 cm, 8 ¼"
Double ended probe,
malleable, diam, of tips
3 mm with hole



LG8-023-250 25.0 cm, 10"
LG8-024-300 30.0 cm, 12"
Double ended probes,
tin, malleable, diam, of tips
3.5 mm with hole



LG8-025-400
40.0 cm, 15 ¾"
Double ended probes,
tin, malleable, diam, of tips
4 mm with hole



LG8-026-300 1.5 mm
LG8-027-300 2.0 mm
LG8-028-300 2.5 mm
30.0 cm, 12"



MARTIN
LG8-029-120 12 cm, 5"
LG8-030-140 14 cm, 5 ½"
LG8-031-160 16 cm, 6 ¼"

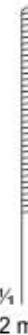

¼
1.2 mm Ø



VOLLMAR
LG8-032-115
11.5 cm, 4 ½"

S I N C E 1 9 8 1



GENERAL INSTRUMENTS

Allgemeines Instrumentarium
Instrumental general

Instrumentation générale
Strumentario generale



CUTICLE NIPPER
LG8-033-110
11 cm, 4 1/2"



NAIL NIPPER

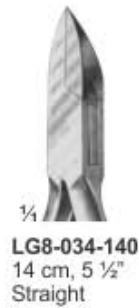

LG8-034-140
14 cm, 5 1/2"
Straight



LG8-035-140
14 cm, 5 1/2"
Concave



NAIL CLIPPER
LG8-036-140
14 cm, 5 1/2"
Angled / Concave



1/4



NAIL NIPPER
LG8-037-130
13 cm, 5 1/4"
Straight



NAIL NIPPER
LG8-038-105
10.5 cm, 4"



NAIL NIPPER
LG8-039-150
15.0 cm, 6"
Barrel Spring
Concave



1/4



NAIL NIPPER
LG8-040-130
13 cm, 5 1/4"
Barrel Spring
Concave



REVERDIN NEEDLES

Reverdin nadeln
aguja de reverdin

Aguilles de reverdin
aghi di reverdin



REVERDIN
short



LG8-041-145
14.5 cm, 5 3/4"



LG8-042-145
14.5 cm, 5 3/4"



LG8-043-145
14.5 cm, 5 3/4"



LG8-044-145
14.5 cm, 5 3/4"



REVERDIN NEEDLE
LG8-045-195 -
LG8-048-195
Small



LG8-045-195
19.5 cm, 7 3/4"
LG8-045-230
23 cm, 9"



LG8-046-195
19.5 cm, 7 3/4"
LG8-046-230
23 cm, 9"



LG8-047-195
19.5 cm, 7 3/4"
LG8-047-230
23 cm, 9"



LG8-048-195
19.5 cm, 7 3/4"
LG8-048-230
23 cm, 9"



REVERDIN
LG8-045-230 -
LG8-048-230
long



REVERDIN NEEDLES

Reverdin nadeln
aguja de reverdin

Aguilles de reverdin
aghi di reverdin

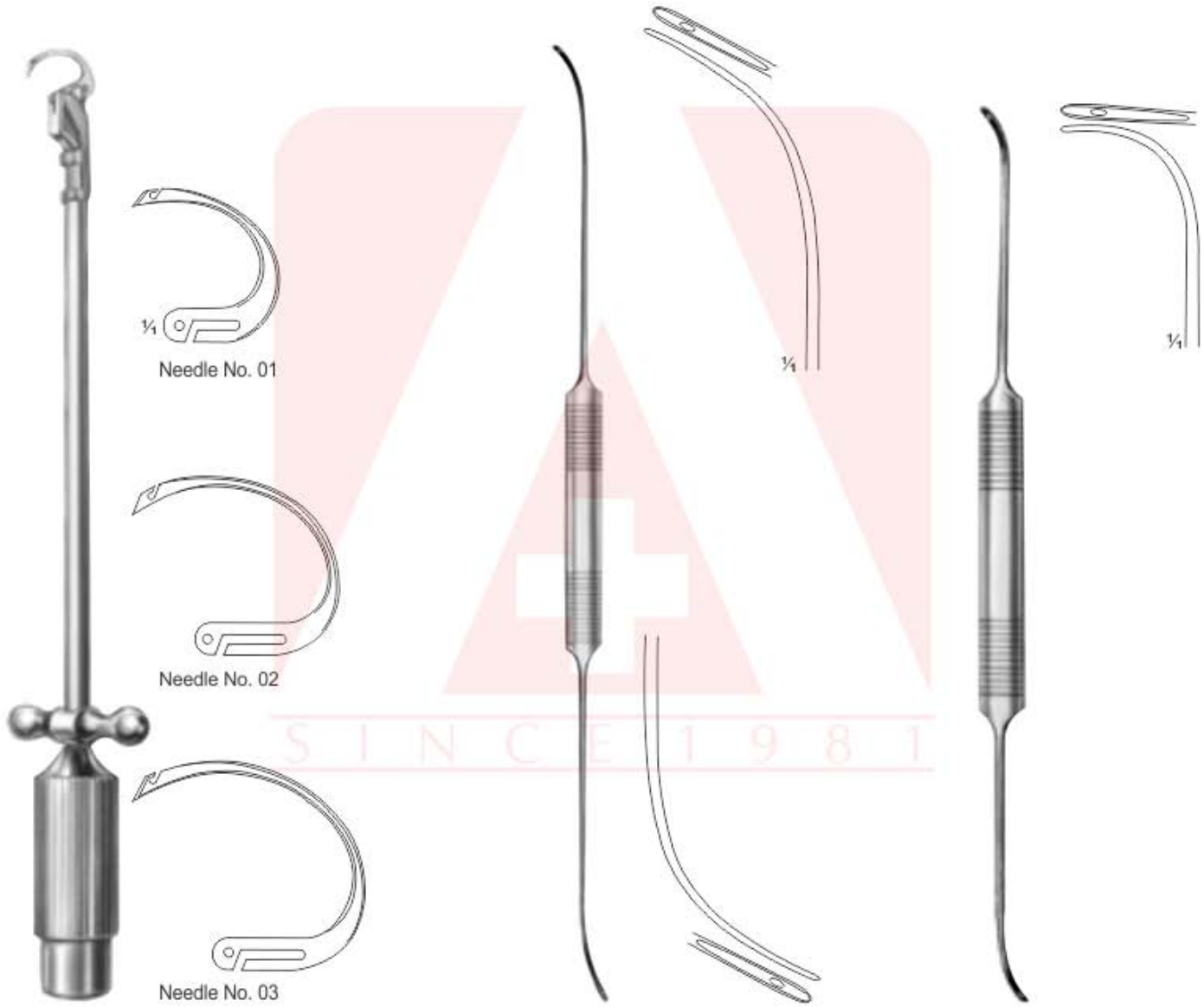

YOUNG
LG8-049-245
24.5 cm, 10"
Complete
with on
Needle no. 01

SCHMIEDEN-DICK
LG8-050-290
29 cm, 11 1/2"
malleable

SCHMIEDEN
LG8-051-240
24 cm, 9 1/2"



LIGATUTR NEEDLES

Unterbindungsnadeln
aguja para ligaduras

Aiguilles à ligatures
aghi di legatura



LIGATURE NEEDLE
LG8-052-200
20 cm, 8"

COOPER
LG8-053-190
19 cm, 7 1/2"

KRONECKER
LG8-054-130
13 cm, 5 1/4"
delicate
for right hand

KRONECKER
LG8-055-130
13 cm, 5 1/4"
delicate
for left hand

DESCHAMPS
LG8-056-240
24 cm, 9 1/2"

DESCHAMPS
LG8-057-240
24 cm, 9 1/2"



INTESTINAL AND RECTAL INSTRUMENTS





INTESTINAL & TISSUE GRASPING FORCEPS

Darm-und Gewebefasszangen
Pinzas Para Intestinos y Tejidos

Pinces Pour Saisir Intestins et Tissus
Pinze Per Afferrare Intestino e Tessuti

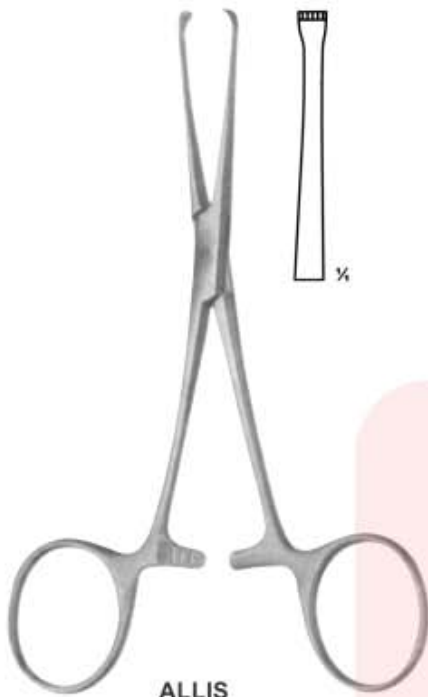

ALLIS
LG13-001-155
3 x 4 teeth
15.5 cm, 6"

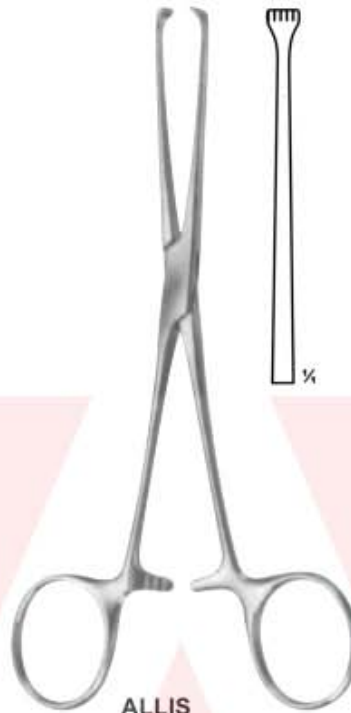

ALLIS
LG13-002-155
4 x 5 teeth
15.5 cm, 6"

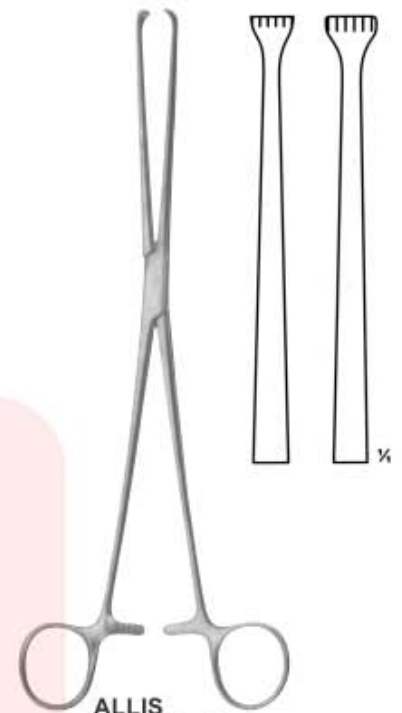

ALLIS
LG13-003-190
19.0 cm, 7 1/2"
LG13-004-255
25.5 cm, 10"
5 x 6 teeth

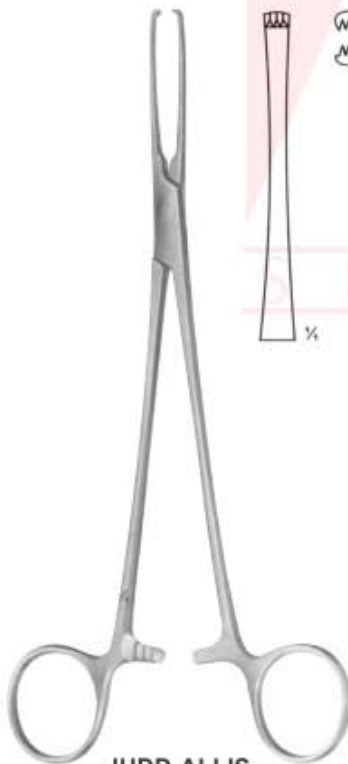

JUDD-ALLIS
LG13-005-195
3 x 4 teeth
19.5 cm, 7 3/4"



WILLIAMS
LG13-006-160
16 cm, 6 1/4"



INTESTINAL & TISSUE GRASPING FORCEPS

Darm-und Gewebefasszangen
Pinzas Para Intestinos y Tejidos

Pinces Pour Saisir Intestins et Tissus
Pinze Per Afferrare Intestino e Tessuti



BABCOCK



LG13-007-155
15.5 cm, 6"



LG13-008-170
17.0 cm, 6 3/4"



LG13-009-215
21.5 cm, 8 1/2"

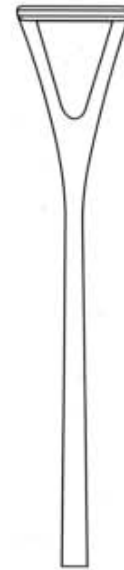

LG13-010-220
22.0 cm, 8 3/4"



COLLIN
LG13-011-140
14.0 cm, 5 1/2"

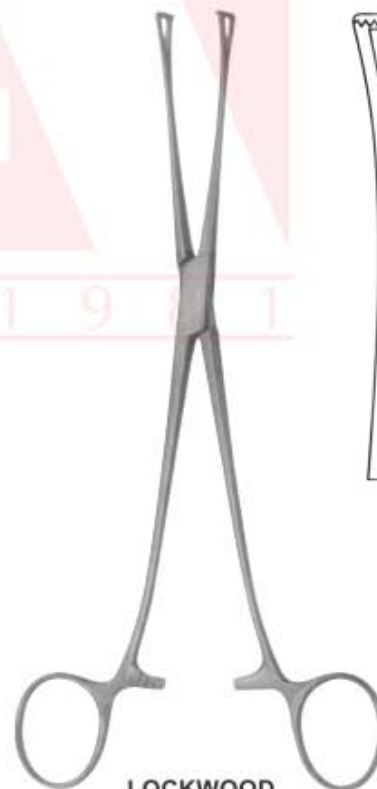

LOCKWOOD
LG13-012-200
20.0 cm, 8"



SINCE 1911



INTESTINAL & TISSUE GRASPING FORCEPS

Darm-und Gewebefasszangen
Pinzas Para Intestinos y Tejidos

Pinces Pour Saisir Intestins et Tissus
Pinze Per Afferrare Intestino e Tessuti



ALLIS



LG13-013-155
15.5 cm, 6"



LG13-014-200
20.0 cm, 8"



LG13-015-220
22.0 cm, 8 3/4"



LG13-016-255
25.5 cm, 10"



LG13-017-300
30.0 cm, 12"



COLLIN
LG13-020-195
19.5 cm, 7 3/4"



1/4



COLLIN
LG13-021-230
23.0 cm, 9"

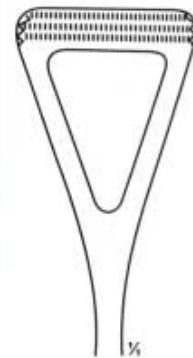

1/4

SINCE 1981



INTESTINAL & TISSUE GRASPING FORCEPS, INTESTINAL CLAMPS

Darm- und Gewebefasszangen, Darmklemmen
Pinzas Para Intestinos y Tejidos, Pinzas Intestinales

Pinces Pour Saisir Intestins et Tissus, Pincés Intestinales
Pinze Per Afferrare Intestino e Tessuti, Pinze Intestinali

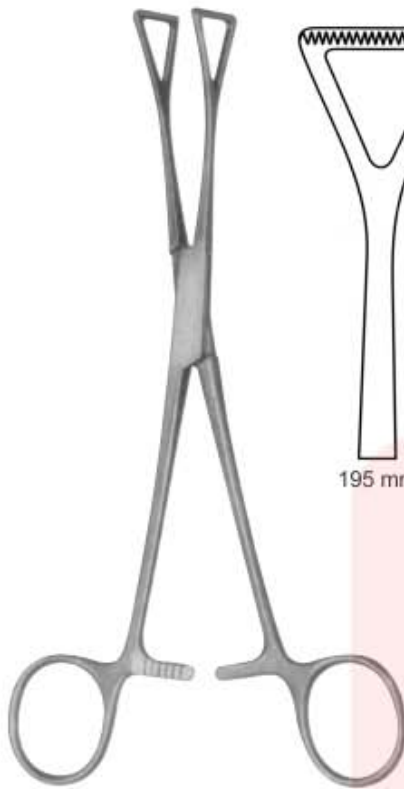

DUVAL-COLLIN
LG13-022-195
19.5 cm, 7 3/4"
LG13-023-200
20.0 cm, 8"

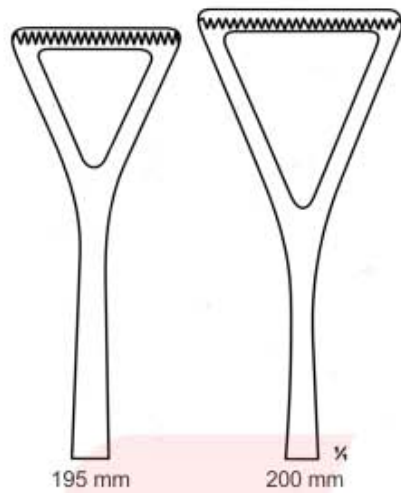

195 mm

200 mm



DUVAL
LG13-024-230
23.0 cm, 9"



BABCOCK
LG13-025-160 16 cm, 6 1/4"
LG13-026-180 18 cm, 7"
LG13-027-240 24 cm, 9 1/2"



LG13-028-220
22 cm, 8 3/4"
Straight



LG13-029-250
25 cm, 10"
Straight



LG13-030-280
28 cm, 11"
Straight



KOCHER



LG13-031-220
22 cm, 8 3/4"
Curved



LG13-032-250
25 cm, 10"
Curved



LG13-033-280
28 cm, 11"
Curved



INTESTINAL CLAMPS

Darmklemmen
Pinzas Intestinales

Pinces Intestinales
Pinze Intestinali

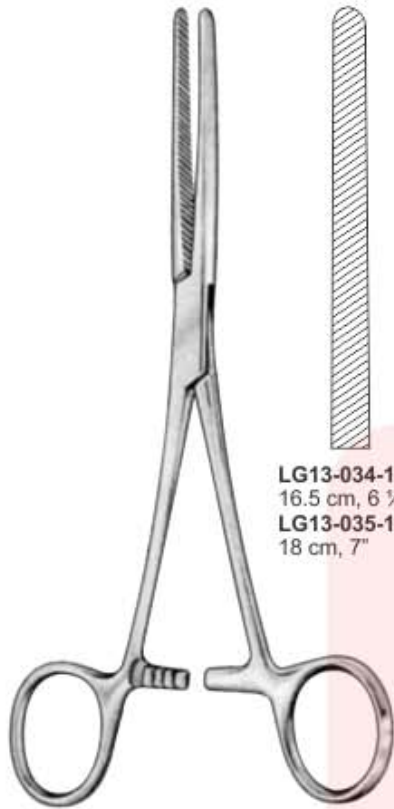

LG13-034-165
16.5 cm, 6 1/2"
LG13-035-180
18 cm, 7"

BABY-DOYEN

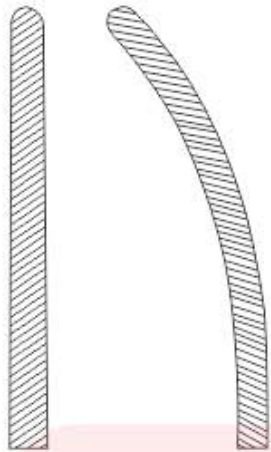

LG13-036-165
16.5 cm, 6 1/2"
LG13-037-180
18 cm, 7"



MAYO-ROBSON

LG13-038-210
21 cm, 8 1/4"
LG13-039-230
23 cm, 9"
LG13-040-250
25 cm, 10"

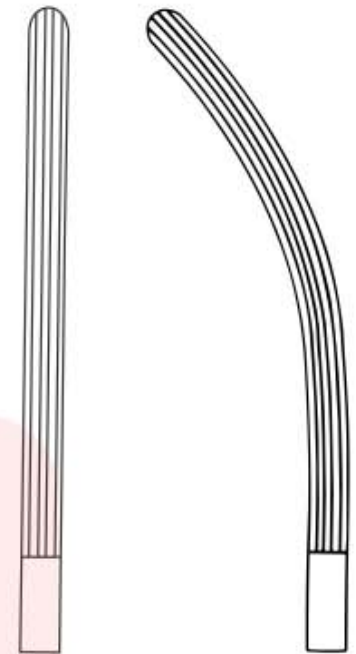

LG13-041-210
21 cm, 8 1/4"
LG13-042-230
23 cm, 9"
LG13-043-250
25 cm, 10"

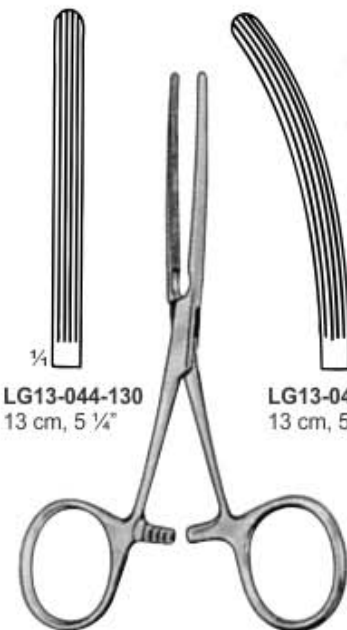

LG13-044-130
13 cm, 5 1/4"

BABY-KOCHER



LG13-045-130
13 cm, 5 1/4"



KOCHER

LG13-046-220
22 cm, 8 3/4"
Straight



DOYEN

LG13-047-210
21 cm, 8 1/4"
LG13-048-230
23 cm, 9"
straight,
grooved

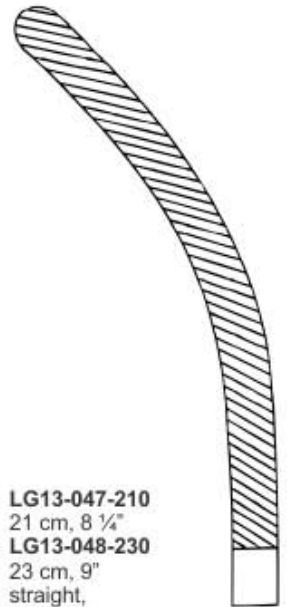

LG13-049-220
22 cm, 8 3/4"
Curved,
grooved



INTESTINAL CLAMPS

Darmklemmen
Pinzas Intestinales

Pinces Intestinales
Pinze Intestinali



DOYEN



LG13-050-130
13 cm, 5 1/4"



LG13-051-160
16 cm, 6 1/4"



LG13-052-180
18 cm, 7"



LG13-053-210
21 cm, 8 1/4"

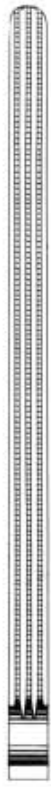

LG13-054-230
23 cm, 9"



DOYEN



LG13-055-130
13 cm, 5 1/4"



LG13-056-160
16 cm, 6 1/4"

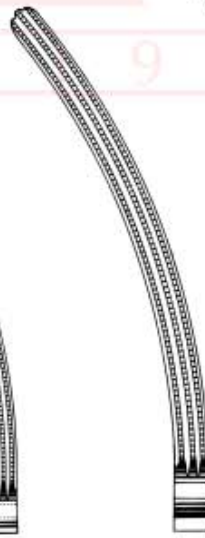

LG13-057-180
18 cm, 7"

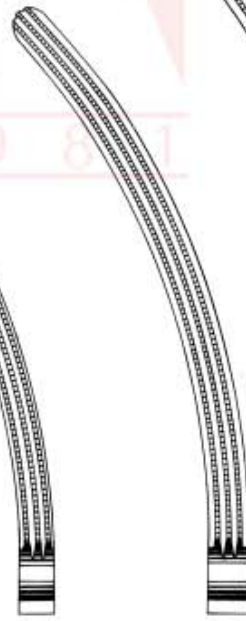

LG13-058-210
21 cm, 8 1/4"



LG13-059-230
23 cm, 9"



POLYOUS GRASPING FORCEPS, ANASTOMOSIS

Polypenfasszange, Darm-anastomosenklammern

Pince Pour Saisir Polypes, Pincés-clamps Pour Anastomose Intestinale

Pinza Para Coger Pólipos, Clamps Para Anastomosis Intestinales

Pinze Per Afferrare Polipi, Pinze Per Anastomosi Intestinali

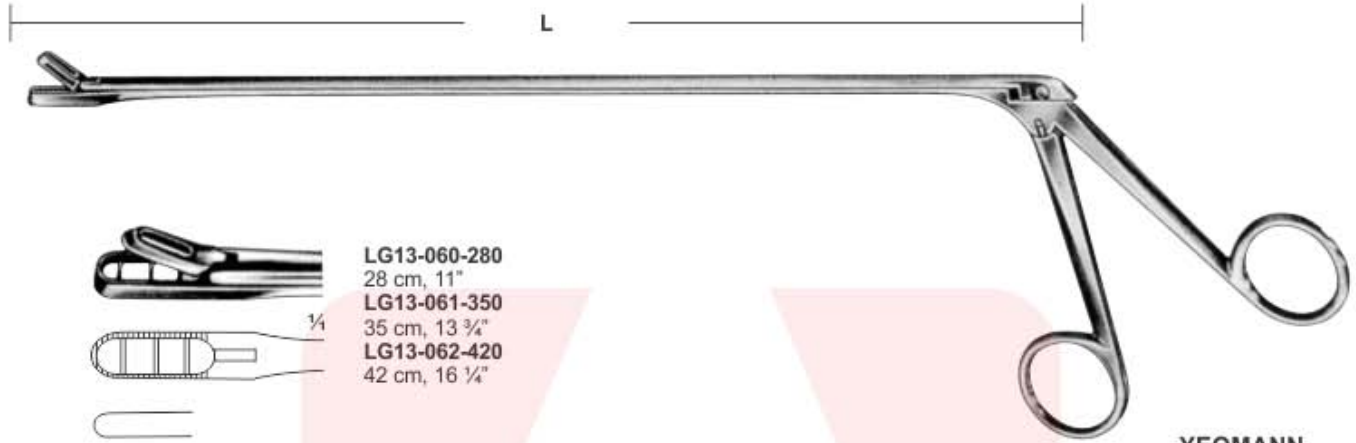

LG13-060-280

28 cm, 11"

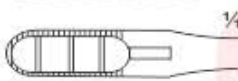

LG13-061-350

35 cm, 13 3/4"



LG13-062-420

42 cm, 16 1/4"

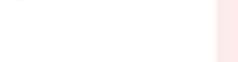

LG13-063-280

28 cm, 11"



LG13-064-350

35 cm, 13 3/4"

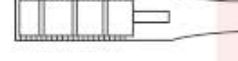

LG13-065-420

42 cm, 16 1/4"



LG13-066-280

28 cm, 11"



LG13-067-350

35 cm, 13 3/4"



LG13-068-420

42 cm, 16 1/4"



LG13-069-280

28 cm, 11"

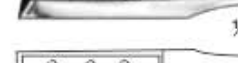

LG13-070-350

35 cm, 13 3/4"



LG13-071-420

42 cm, 16 1/4"



S I N C E 1 9 8 1



INTESTINAL CLAMPS

Darmklemmen
Pinzas Intestinales

Pinces Intestinales
Pinze Intestinali

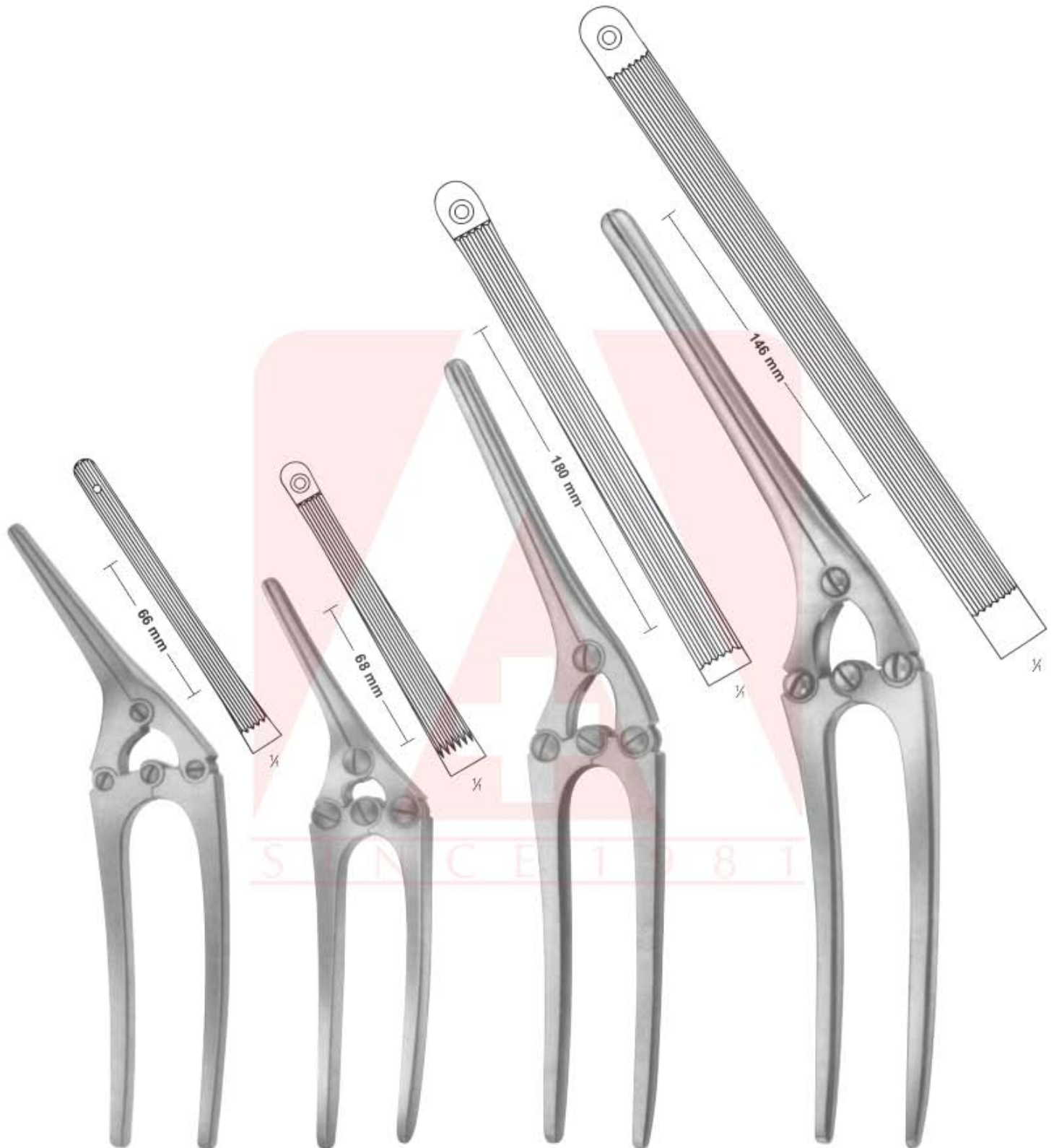

PAYR-BABY
LG13-072-150
15 cm, 6"
without pin
LG13-073-150
15 cm, 6"
with pin

PAYR
LG13-074-210
21 cm, 8 1/4"
without pin
LG13-075-210
21 cm, 8 1/4"
with pin

PAYR
LG13-076-290
29 cm, 11 1/2"
without pin
LG13-077-290
29 cm, 11 1/2"
with pin

PAYR
LG13-078-350
35 cm, 13 3/4"
without pin
LG13-079-350
35 cm, 13 3/4"
with pin



INTESTINAL CLAMPS

Darmklemmen
Pinzas Intestinales

Pinces Intestinales
Pinze Intestinali

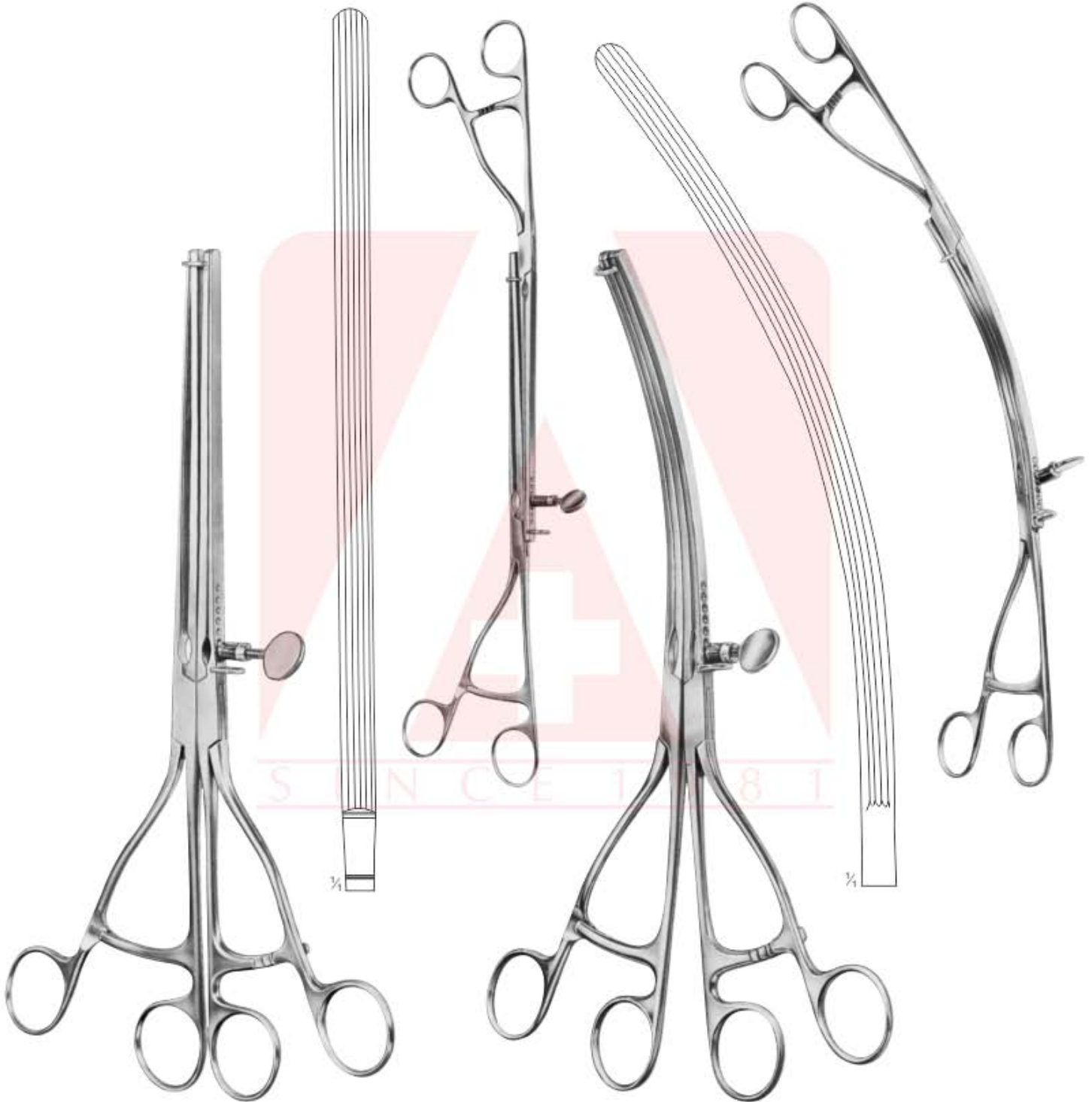

LANE Str.
LG13-080-300
30 cm, 12"

LANE Cvd.
LG13-081-300
30 cm, 12"



INTESTINAL RECTAL SPECULA

Mastdarmspekula
Especulos Rectales

Spéculums Rectaux
Specoli Rettali



90 x 15 mm

MATHIEU
LG13-082-195
19.5 cm, 7 3/4"
90 x 15 mm



SIMS
LG13-083-150
15 cm, 6"



SIMS
LG13-084-150
15 cm, 6"



IVES-FANSLER
LG13-085-145
14.5 mm, 5 3/4"
22 mm Ø



PRATT
LG13-086-215
21.5 cm, 8 1/2"
85 x 25 mm blade

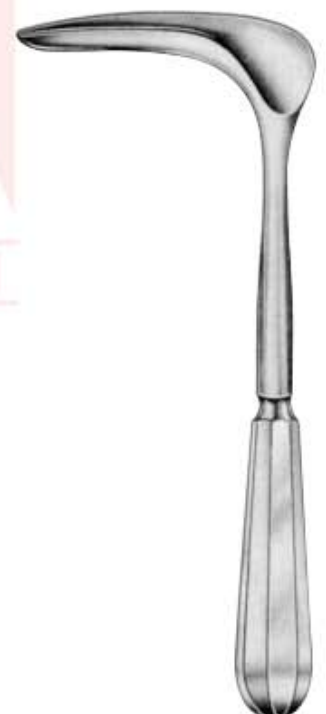

CZERNY
LG13-087-220
22 cm, 8 3/4"



INTESTINAL RECTAL SPECULA

Mastdarmspekula
Especulos Rectales

Spéculums Rectaux
Specoli Rettali

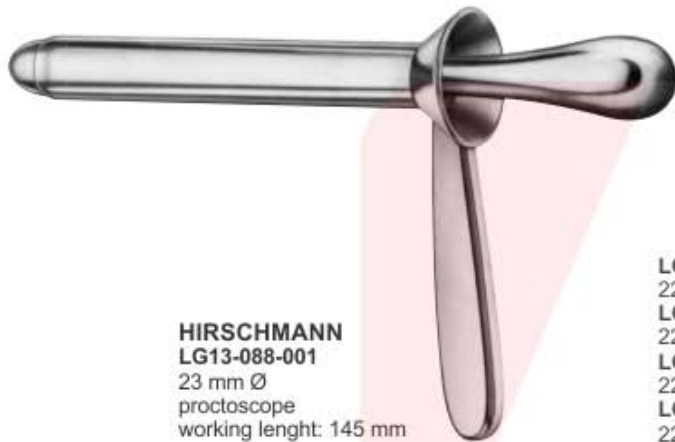

HIRSCHMANN
LG13-088-001
23 mm Ø
proctoscope
working length: 145 mm



LG13-089-001
22 ø x 50 mm
LG13-090-002
22 ø x 100 mm
LG13-091-003
22 ø x 140 mm
LG13-092-004
22 ø x 200 mm

KELLY



LG13-093-001
19 ø x 70 mm
LG13-094-002
22 ø x 70 mm

BENSAUDE



SMITH-BLUE
LG13-095-150
15 cm, 6"
75 x 23 mm



SCHULZE-BERGMANN
22 cm, 8 3/4"

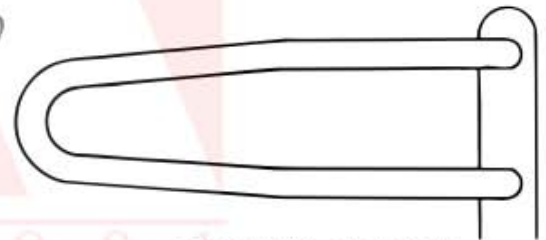

LG13-096-220 22 cm, 8 3/4"
20 x 65 mm
LG13-097-220 22 cm, 8 3/4"
25 x 85 mm
LG13-098-220 22 cm, 8 3/4"
25 x 120 mm
LG13-099-220 22 cm, 8 3/4"
23 x 145 mm



INDEX

INDEX



INDEX

| DESCRIPTION | PAGE # | DESCRIPTION | PAGE # |
|---|----------|--|----------|
| A | | | |
| Abdominal Retractor | 147, 263 | Balfour Retractor | 144 |
| Adlerkreutz Tissue Forceps | 82 | Ball & Socket Forceps | 75 |
| Adson / Micro-Adson Tissue & Dressing Forceps | 86 | Barbara Tympanum Needle..... | 208 |
| Adson Haemostatic Forceps | 63 | Barnes-Neville Obstetrical Forceps | 286 |
| Adson Elevator | 157 | Barraquer Needle Holder..... | 100 |
| Adson Haemostatic Forceps | 63 | Barraquer-Troutman Needle Holder | 100 |
| Adson Spherical Burrs..... | 191 | Barrett Tenaculum Forceps | 265 |
| Adson Suction Tube | 15 | Barth Ear Curette..... | 208 |
| Adson Tissue & Dressing Forceps T.c..... | 298 | Baumgartner Needle Holders | 95 |
| Adson-Brown Dressing Forceps..... | 86 | Beacham Tonsil Forceps | 233 |
| Aesculap Esophagoscopy Forceps | 238 | Beckmann Nasal Speculum | 219 |
| Agnew Tympanum Perforator | 207 | Beebee Scissors..... | 45 |
| Alexander Chisel | 157 | Bellucci Micro Scissor..... | 215 |
| Alexander Gouge..... | 157 | Bengolea Haemostatic Forceps | 66 |
| Alexander Uterine Biopsy Forceps | 276 | Bensaude Intestinal Rectal Specula..... | 250 |
| Allis Intestinal Forceps..... | 240, 242 | Berger Uterine Biopsy Forceps | 277 |
| ALM Retractor | 139 | Berliner Hammer | 02 |
| Amputation Knife | 30 | Bernhard Towel Forceps..... | 75 |
| Andrews-pynchon Suction Tube..... | 16 | Beyer Bone Rongeur..... | 169, |
| Arruga Needle Holders | 99 | Beyer Mastoid Rongeur..... | 214 |
| Aufricht Rasp..... | 223 | Biemer Suction Tube | 13 |
| Auvard Vaginal Specula | 260 | Billeau Currete..... | 209 |
| B | | | |
| Babcock Intestinal Forceps | 241, 243 | Birch Trocar | 18 |
| Babcock Operating Scissors T.c..... | 295 | Blade Holder Blade Breaker | 23 |
| Babinsky Hammer | 02 | Blake Gall Stone Forceps..... | 292 |
| Baby Crile-Wood Needle Holders..... | 96 | Blake Suction Curettes | 267 |
| Baby-Collin Retractor | 146 | Blalock Rib Contractor..... | 182 |
| Baby-Doyen Intestinal Clamps | 244 | Blount Retractor..... | 117 |
| Baby-Kocher Intestinal Clamps | 244 | Blumenthal Bone Rongeur | 168 |
| Baby-Mixter Haemostatic Forceps | 67 | Böhler Bone Rongeur | 170 |
| Baby-Roux Retractor | 118 | Bone Ring Cutting Forceps | 173 |
| Baby-Satinsky Vascular Clamp | 181 | Bone Shear..... | 187 |
| Baby-Senn Mueller Retractor | 108 | Bone Tamps..... | 160 |
| Backhaus Clip Forceps..... | 75 | Bonney Tissue Forceps | 84 |
| Backhaus Towel Forceps..... | 74 | Bose Hook..... | 103, 234 |
| Bailey-Baby Rib Contractor | 182 | Boucheron Ear Specula..... | 204 |
| Bailey-Gibbon Rib Contractor..... | 182 | Bozemann Haemostatic Forceps | 73 |
| Bainbridge Haemostatic Forceps | 64 | Bozemann Needle Holders T.c..... | 296 |
| Bakes Gall Duct Dilator | 289 | Bozemann Needle Holders..... | 96 |
| | | Bozemann-Douglas Haemostatic Forceps | 73 |
| | | Brand Tendon Tunnelling Forceps | 165 |
| | | Braun Obstetrical Forceps..... | 286 |
| | | Braun Tonsil Forceps..... | 233 |
| | | Braun Uterine Biopsy Forceps..... | 281 |
| | | Braun Uterine Depressor..... | 267 |
| | | Braun Vaginal Speculum | 256 |



INDEX

| DESCRIPTION | PAGE # | DESCRIPTION | PAGE # |
|--|----------|---|---------------|
| Braun-Stadler Scissors | 51 | Castroviejo Needle Holder..... | 100 |
| Breisky Pelvimeter..... | 284 | Castroviejo Needle Holders T.c | 297 |
| Breisky Wiener Vaginal Specula | 259, 259 | Castroviejo Olsen Heager / Needle Holders / Scissors .. | 99 |
| Bridge Haemostatic Forceps | 64 | Castroviejo-Epker Caliper | 11 |
| Briesky Vaginal Speculum | 257 | Catheter Urethral Catheters | 290 |
| Brodie Probe..... | 149 | Catlin Amputation Knife | 30 |
| Brom Hook..... | 104 | Catlin Dissecting Knife..... | 28 |
| Brophy (Sullivan) Scissors..... | 43 | Chaput Haemostatic Forceps | 52 |
| Brophy Dressing Forceps | 81 | Charnley-Mueller Compression Clamp..... | 166 |
| Brophy Tissue Forceps | 82 | Charriere Amputation Saw..... | 161 |
| Brown Dressing Forceps | 86 | Charriere Saw..... | 30 |
| Brown Needle Holders..... | 95, 97 | Cheek & Lip Retractor (Movable) | 128 |
| Bruenings Septum Forceps | 222 | Cheron Forceps Sponge Forceps | 77 |
| Bruenings Tongue Depressor | 228 | Chevalier-Jackson Tracheal Tube | 236 |
| Brünings Esophagoscopy Forceps..... | 238 | Christophe Haemostatic Forceps | 56 |
| Brünings Forceps Exchangeable Tip..... | 239 | Citelli Laminectomy Punch | 195 |
| Brunner Retractor | 125 | Citelli Mastoid Rongeur | 214 |
| Brunner Rib Shear..... | 188 | Cleveland Bone Rongeur | 167 |
| Bruns Bandage Scissors | 50 | Cleveland-Gardner Bone Cutting Forceps | 173 |
| Bruns Bone Curette | 162, 163 | Cloward Lamina Spreader..... | 202 |
| Bruns Scissors Operating Scissors T.c..... | 295 | Cloward-Type Rongeur..... | 193 |
| Buchwald Tongue Depressor..... | 228 | Clutton Bougies Urethral Catheters..... | 290 |
| Buck Ear Curette | 208 | Coller Haemostatic Forceps | 56 |
| Buck Ear Polypus Forceps | 211 | Collier Needle Holders..... | 96 |
| Buck Hammer..... | 01 | Collin Intestinal Forceps | 241 |
| Buck Tympanum Needle | 207 | Collin Suction Curettes | 268 |
| Buckley Retractor | 139 | Collin Vaginal Specula..... | 253 |
| Buelau Trocar | 17 | Collin Dissecting Knife..... | 25, 28 |
| Bulldog Clamp | 178 | Collin Intestinal Forceps | 242 |
| Burke Uterine Biopsy Forceps..... | 275 | Collin Obstetrical Forceps | 284 |
| Byrd Suction Tube | 12 | Collin Pelvimeter..... | 284 |
| | | Collin Retractor | 119, 145, 146 |
| | | Collin Scalpel Handle | 21 |
| | | Collin Sponge Forceps | 76 |
| | | Collin Vaginal Specula..... | 253 |
| | | Collin-Duval Dressing Forceps | 85 |
| | | Collin-Hartmann Retractor..... | 109 |
| | | Colver Tonsil Forceps | 232 |
| | | Cone Retractor | 141 |
| | | Conventional Set | 08 |
| | | Cooley Aortic Dilator | 183 |
| | | Cooley Rib Retractor | 184 |
| | | Cooley Suction Tube | 12 |
| | | Cooper Ligature Needle | 154 |
| | | Cope Hooklet..... | 108 |
| | | Cordes Forceps Exchangeable Tip | 239 |

C

| | |
|--|--------|
| Cairns Haemostatic Forceps | 62 |
| Caliper | 11 |
| Caplan Bone Cutting Forceps | 176 |
| Carmalt Splinter Forceps..... | 93 |
| Carrel Haemostatic Forceps..... | 53 |
| Carroll Needle Holders | 96 |
| Carroll Tendon Tunnelling Forceps..... | 165 |
| Caspar Retractor | 122 |
| Castroviejo Blade Holder | 23 |
| Castroviejo Caliper | 11 |
| Castroviejo Micro Scissors | 46, 47 |



INDEX

| DESCRIPTION | PAGE # |
|--|----------|
| Cottle Hook..... | 102 |
| Cottle Nasal Speculum..... | 217, 218 |
| Cottle Retractor..... | 109 |
| Cottle Septal Speculum..... | 220 |
| Coupland Suction Tube..... | 12 |
| Crafoord-Sellors Haemostatic Forceps..... | 66 |
| Crile Haemostatic Forceps..... | 53 |
| Crile Needle Holders..... | 99 |
| Crile Retractor..... | 117 |
| Crile-Rankin Haemostatic Forceps..... | 53 |
| Crile-Wood Needle Holders T.c..... | 297 |
| Crile-Wood Needle Holders..... | 96 |
| Crura-Nipper Micro Ear Forceps..... | 215 |
| Cusco Vaginal Specula..... | 252, 253 |
| Cushing Hook..... | 102, 110 |
| Cushing Love - Gruenwald Spurling Rongeur..... | 193 |
| Cushing Nerve and Vessel Hook..... | 111 |
| Cushing Retractor..... | 111 |
| Cushing Rongeur..... | 192 |
| Cushing Spherical Burr..... | 191 |
| Cushing Tissue Forceps..... | 82 |
| Cushing-Kocher Hooklet..... | 110 |
| Cuticle Nipper..... | 151 |
| Czerny Intestinal Rectal Specula..... | 249 |

D

| | |
|--|----------|
| Darling Retractor..... | 141 |
| Dartigues Uterine Seizing Forceps..... | 266 |
| Davis Dressing Forceps..... | 85 |
| Davis-Boyle Mouth Gage..... | 231 |
| De Bakey / Lightweight Dressing Forceps..... | 87 |
| De Bakey Dressing Forceps..... | 87, 88 |
| De Bakey Femur Retractor..... | 142 |
| De Bakey Vascular Clamp..... | 180 |
| De Lee Obstetrical Forceps..... | 284, 286 |
| De Vibiss Vaginal Specula..... | 252 |
| Dean-Delicate Scissors..... | 41 |
| Dean-Shallcross Haemostatic Forceps..... | 68 |
| Deaver Operating Scissors..... | 33 |
| Deaver Retractor..... | 126, 129 |
| Debakey Clamping Forceps..... | 177 |
| De-Bakey Suction Tube..... | 14 |
| Decker Intervertebral Disc Rongeur..... | 199 |
| Dejerine Hammer..... | 01 |

| DESCRIPTION | PAGE # |
|--------------------------------------|------------|
| Denhardt Mouth Gag..... | 229 |
| Denis-Browne Retractor..... | 147 |
| Deschamps Ligature Needle..... | 154 |
| Desjardins Gall Duct Dilator..... | 289 |
| Desmarres Hooklet..... | 110 |
| Diagnostic Set..... | 05, 06 |
| Dieffenbach Clamp..... | 178 |
| Dieffenbach Dissecting Knife..... | 24, 25, 28 |
| Diethrich Clamp..... | 178 |
| Director Probe..... | 149 |
| Dissecting Kit..... | 10 |
| Dissecting Knife..... | 26, 27 |
| Dissecting Scissors..... | 43 |
| Dittel Urethral Catheters..... | 291 |
| Douay Uterine Biopsy Forceps..... | 278 |
| Double Ended Probe..... | 150 |
| Double Prong Micro Hook..... | 101 |
| Douglas Trocar..... | 17 |
| Doyen Intestinal Clamps..... | 244, 245 |
| Doyen Lateral Speculum..... | 259 |
| Doyen Mallet..... | 164 |
| Doyen Myoma Screws..... | 266 |
| Doyen Probe..... | 149 |
| Doyen Retractor..... | 128 |
| Doyen Rib Raspatory..... | 157 |
| Doyen Scissors..... | 37 |
| Doyen Vaginal Retractor..... | 134 |
| Doyen Vaginal Specula..... | 258 |
| Doyen Vaginal Speculum..... | 257 |
| Doyen-Collin Mouth Gag..... | 229 |
| Doyen-Stille Retractor..... | 124 |
| Dressing Forceps..... | 80 |
| Dubois Scissors..... | 38 |
| Duckbill Alligator Ear Forceps..... | 212 |
| Duehrssen Tissue Forceps..... | 85 |
| Duke Trocar..... | 18 |
| Dunhill Haemostatic Forceps..... | 62 |
| Duplay Tonsil Forceps..... | 233 |
| Dura Twist Hook..... | 201 |
| Duval Intestinal Forceps..... | 243 |
| Duval Operating Scissors T.c..... | 295 |
| Duval-Collin Intestinal Forceps..... | 243 |

E



INDEX

| DESCRIPTION | PAGE # |
|--|----------|
| Echlin / Stille-luer Bone Rongeur..... | 169 |
| Echlin Bone Rongeur..... | 171 |
| Eicken Forceps Exchangeable Tip | 239 |
| Electric Mirror | 235 |
| Emmet Hook..... | 103 |
| Engel Plaster Saw | 161 |
| Engl. Modell Towel Forceps..... | 74 |
| Eppendorf Uterine Biopsy Forceps..... | 277, 278 |
| Esmarch Bandage Scissors | 50 |
| Ewald / Hudson Tissue & Dressing Forceps | 86 |

F

| | |
|--|----------|
| Farabeuf Retractor..... | 119 |
| Farabeuf Periosteal Elevator | 156 |
| Farabeuf-Lambotte Bone Holding Forceps | 156 |
| Faure Haemostatic Forceps | 72 |
| Faure Uterine Biopsy Forceps | 280 |
| Feilchenfeld Splinter Forceps | 93 |
| Ferguson-Ackland Mouth Gag..... | 229 |
| Fergusson Scissors | 34 |
| Fergusson Suction Tube..... | 227 |
| Fergusson Tubing Clamp Forceps | 78 |
| Ferris-Smith Laminectomy Rongeur..... | 198 |
| Ferris-Smith Tissue Forceps..... | 84 |
| Fiberoptic Set | 08 |
| Finocchietto (Modif.) Rib Retractor..... | 185 |
| Finocchietto Needle Holders | 97 |
| Finocchietto Rib Retractor..... | 184 |
| Finsterer Suction Tube | 20 |
| Fisch Ear Hooklet | 210 |
| Fisch Hooklet..... | 101 |
| Flat Nosed Parallel Plier..... | 165 |
| Flat Nosed Plier | 165 |
| Fleurant Trocar | 17 |
| Foerster-Ballenger Sponge Forceps | 76, 78 |
| Foman Rasp | 160, 224 |
| Fomon Hook | 102, 111 |
| Foregger Laryngoscope Set..... | 07 |
| Fraenkel Forceps Exchangeable Tip | 239 |
| Frazier Hook..... | 101, 201 |
| Frazier Suction Tube | 15, 227 |
| Frazier-Ferguson Suction Tube | 15 |
| Freer Hooklet..... | 101 |
| Friedman & Mini-Friedman Bone Rongeur..... | 168 |

| DESCRIPTION | PAGE # |
|---------------------------------|--------|
| Friedmann Vaginal Speculum..... | 263 |
| Fritsch Retractor | 128 |
| Fulton Scissors..... | 42 |

G

| | |
|---|----------|
| Galabin Uterine Sounds | 272 |
| Galt Drill..... | 191 |
| Garland Haemostatic Forceps..... | 69 |
| Gauss Obstetrical Forceps | 283 |
| Gayne Evans Tonsil Dissector..... | 234 |
| Gellhorn Uterine Biopsy Forceps..... | 280 |
| Gelpi Skin & Vaginal Retractor | 142 |
| Gelpi Vaginal Retractor..... | 142 |
| Gelpi-Loktite Retractor..... | 141 |
| Gemini Haemostatic Forceps | 63 |
| Gerald Tissue Forceps | 81 |
| Gerzog-Sexton Tympanum Needle | 207 |
| Giertz-Stille Rib Shear | 188 |
| Gigli Handle | 161 |
| Gillies Hook | 101, 201 |
| Gillies Needle Holders T.c. | 297 |
| Gillies Tissue Forceps | 82, 87 |
| Gluck Rib Shear | 187 |
| Goelet Retractor | 133 |
| Goldman-Fox Scissors | 41 |
| Gorney Suction Dissector..... | 16 |
| Gosset Retractor | 143 |
| Gourdet Uterine Depressor | 268 |
| Graefe Dressing Forceps | 91 |
| Graefe Tissue & Dressing Forceps..... | 91 |
| Graves Vaginal Specula | 251 |
| Graves Vaginal Speculum | 251 |
| Grazil Operating Scissors..... | 33 |
| Green Retractor | 115 |
| Green-Armytage Obstetrical Forceps..... | 283 |
| Green-Armytage Placenta Forceps | 282 |
| Gregory-Soft Clamping Forceps..... | 177 |
| Groenholm Hook | 104 |
| Gross Ear Hooklet | 210 |
| Gross-Maier Sponge Forceps | 77 |
| Gruenwald-Henke Nasal Cutting Forceps | 226 |
| Guedel-Negus / Miller Laryngoscope Set..... | 06 |
| Guedel-Negus Diagnostic Set | 04 |
| Gumco Clamp..... | 293 |



INDEX

| DESCRIPTION | PAGE # |
|--------------------------------|----------|
| Guthrie Hooklet..... | 101 |
| Guyon Haemostatic Forceps..... | 71 |
| Guyon Urethral Catheters..... | 290, 291 |

H

| | |
|---|----------|
| Haig Ferguson Obstetrical Forceps..... | 286 |
| Haight Rib Retractor..... | 185 |
| Hajek-Kofler Laminectomy Punch..... | 195 |
| Halle Nasal Speculum..... | 220 |
| Halsted-Mosquito Haemostatic Forceps..... | 54, 55 |
| Hank Gyne Uterine Dilators..... | 273 |
| Hank Uterine Dilators..... | 273 |
| Hartmann / French Tuning Fork..... | 205 |
| Hartmann / Mosquito Haemostatic Forceps..... | 56 |
| Hartmann Alligator Ear Forceps..... | 212 |
| Hartmann Bone Rongeur..... | 168 |
| Hartmann Ear Hooklet..... | 210 |
| Hartmann Ear Specula..... | 204 |
| Hartmann Eustachian Catheters..... | 204 |
| Hartmann- French Tuning Fork..... | 206 |
| Hartmann Hook..... | 103 |
| Hartmann Nasal Cutting Forceps..... | 226 |
| Hartmann Nasal Speculum..... | 219 |
| Hartmann Septum Forceps..... | 221 |
| Hartmann Tuning Fork..... | 205, 206 |
| Hartmann-Halle Nasal Speculum..... | 219 |
| Hartmann-Hoffmann Alligator Ear Forceps..... | 212 |
| Hartmann-Noyes Alligator Ear Forceps..... | 212 |
| Hartmann-Wullstein Alligator Ear Forceps..... | 212 |
| Heaney / Ballantine Haemostatic Forceps..... | 69 |
| Heaney / Rezak Haemostatic Forceps..... | 69 |
| Heaney Haemostatic Forceps..... | 69, 70 |
| Heaney Needle Holders T.c..... | 297 |
| Heath Scissors..... | 42 |
| Hegar Gyne Uterine Dilators..... | 274 |
| Hegar Uterine Dilators..... | 273 |
| Hegemann-Diethrich Scissors..... | 42 |
| Heiss Haemostatic Forceps..... | 66 |
| Heister Mouth Gag..... | 230 |
| Henley Retractor..... | 140 |
| Herbert Mallet..... | 164 |
| Herrick Haemostatic Forceps..... | 68 |
| Hertzler Rib Retractor..... | 186 |
| Hey Groves Bone Holding Forceps..... | 156 |

| DESCRIPTION | PAGE # |
|---|----------|
| Heymann Scissors..... | 43 |
| Heymann Septum Forceps..... | 222 |
| Heymann-Knight Septum Forceps..... | 221 |
| Heywood Smith Sponge Forceps..... | 76, 77 |
| Hibbs-Spratt / Angled Bone Curette..... | 163 |
| Hirschmann Intestinal Rectal Specula..... | 250 |
| Holsher Nerve Retractor..... | 203 |
| Holzbach Retractor..... | 146 |
| Hooklet & Skin Hooks..... | 101, 102 |
| Hooklets & Retractors..... | 105 |
| Horizontal Retractor..... | 140 |
| Horrocks Uterine Sound..... | 272 |
| Horsley Bone Cutting Forceps..... | 175 |
| House Suction Tube..... | 20 |
| House-Dieter Micro Ear Forceps..... | 214 |
| Huber Esophagoscopy Forceps..... | 238 |
| Hudson Brace Drill..... | 191 |
| Hudson Spherical Burrs..... | 191 |
| Hulka Gyne Uterine Tenaculum Forceps..... | 264 |
| Hunter Splinter Forceps..... | 93 |

I

| | |
|---|----------|
| Incision Scissors..... | 34 |
| Inge Lamina Spreader..... | 202 |
| Iowa Tonsil Forceps..... | 232 |
| Iowa Uterine Seizing Forceps..... | 266 |
| Iris Operating Scissors T.c..... | 295 |
| Iris Scissors..... | 39, 40 |
| Iverson Hook..... | 103, 234 |
| Ives-Fansler Intestinal Rectal Specula..... | 249 |

J

| | |
|-------------------------------------|-----|
| Jackson Hook..... | 234 |
| Jackson Vaginal Specula..... | 255 |
| Jacobs Uterine Seizing Forceps..... | 266 |
| Jacobson Haemostatic Forceps..... | 56 |
| Jacobson Needle Holders T.c..... | 296 |
| Jameson Caliper..... | 11 |
| Jameson Needle Holders..... | 97 |
| Janden Ear Curette..... | 208 |
| Jansen Ear Forceps..... | 216 |
| Jansen Retractor..... | 139 |



INDEX

| DESCRIPTION | PAGE # |
|---|--------|
| Jansen-Gruenwald Dressing Forceps | 85 |
| Jeweler Type, Dissecting Forceps | 92 |
| Jeweler's Forceps | 92 |
| Jones / Perforating Towel Forceps | 74 |
| Joseph Hook | 102 |
| Joseph Rasp | 224 |
| Joseph Scissors | 37 |
| Judd-Allis Intestinal Forceps | 240 |

K

| | |
|--|----------|
| Kader Malleable Retractor | 130 |
| Kader Rigid Retractor | 130 |
| Kahler Forceps Exchangeable Tip | 239 |
| Kallmorgen Vaginal Retractor | 257 |
| Kallmorgen Vaginal Speculum | 257 |
| Kantrowitz Haemostatic Forceps | 64 |
| Kay Vascular Clamp | 180 |
| Kaye Face-Lift Scissors | 36 |
| Kaye-Millard Vein Hook | 133 |
| Kelly Haemostatic Forceps | 53 |
| Kelly Intestinal Rectal Specula | 250 |
| Kelly Retractor | 127, 138 |
| Kelly Scissors | 38 |
| Kelly Sponge Forceps | 78 |
| Kelly-Rankin Haemostatic Forceps | 53 |
| Kern Bone Holding Forceps | 156 |
| Kerrison Sphenoid Bone Punch | 225 |
| Kevorkian Suction Curettes | 267 |
| Kevorkian Uterine Biopsy Forceps | 278, 279 |
| Kevorkian-Pacific Uterine Biopsy Forceps | 276 |
| Keyes Dermal Punch | 228 |
| Kielland Obstetrical Forceps | 285 |
| Kielland-Luikart Obstetrical Forceps | 286 |
| Killian Nasal Speculum | 217, 220 |
| Killian Septum Forceps | 221 |
| Kilner Hook | 101, 103 |
| Kilner Scissors | 37 |
| Kirschner American Type Sleeve | 166 |
| Kirschner Retractor | 148 |
| Kirschner Sleeve | 166 |
| Kirschner-Balfour Retractor | 148 |
| Kirstein Nasal Scissors | 222 |
| Klapp Hook | 116 |
| Kleinert-Kutz Bone Rongeur | 170 |

| DESCRIPTION | PAGE # |
|---|-------------------------|
| Klinikum Berlin Tubing Clamp Forceps | 78 |
| Knapp Iris Scissors | 40 |
| Knowles Scissors | 51 |
| Knutson Urethrographie-instruments | 293 |
| Kocher / Delicate Haemostatic Forceps | 58 |
| Kocher Haemostatic Forceps | 61 |
| Kocher Hooklet | 106 |
| Kocher Intestinal Clamps | 244 |
| Kocher Intestinal Forceps | 243 |
| Kocher Retractor | 111, 112, 120, 124, 135 |
| Kocher-Langenbeck Retractor | 122 |
| Koenig Tuning Fork | 206 |
| Koerte Retractor | 120, 137 |
| Kogan Gyne Uterine Tenaculum Forceps | 264 |
| Kogan Uterine Tenaculum Forceps | 264 |
| Konig Retractor | 109 |
| Korte-Wagner Retractor | 120 |
| Krause Forceps Exchangeable Tip | 239 |
| Kristeller Vaginal Specula | 254 |
| Kronecker Ligature Needle | 154 |
| Kronlein Haemostatic Forceps | 57 |
| Kuemmel Malleable Retractor | 131 |
| Kuemmel Retractor | 137 |
| Kummel Retractor | 131 |

L

| | |
|--------------------------------------|--------------------|
| Lahey Clinic Hook | 201 |
| Lahey Tonsil Forceps | 232 |
| Lambotte Osteotome | 159 |
| Lambotte Periosteal Elevator | 156 |
| Landau Trocar | 18 |
| Landau Vaginal Specula | 259 |
| Landolt Suction Tube | 19, 20 |
| Landon Vaginal Retractor | 257 |
| Lane Bone Holding Forceps | 155 |
| Lane Intestinal Clamps | 248 |
| Lane Tissue Forceps | 84 |
| Lange Forceps Exchangeable Tip | 239 |
| Lange Hook | 103 |
| Langenbeck Amputation Knife | 30 |
| Langenbeck Blade | 28 |
| Langenbeck Ear Curette | 208 |
| Langenbeck Retractor | 113, 114, 116, 123 |
| Langenbeck-Mini Hooklet | 107 |



INDEX

| DESCRIPTION | PAGE # |
|--|----------|
| Laryngeal Mirror | 235 |
| Laryngoscope Battery Handle | 04 |
| Lateral Vaginal Retractor Blue Coated | 262 |
| Lateral Vaginal Retractor | 262 |
| Lawrence Haemostatic Forceps | 64 |
| Le Grange Scissors | 44 |
| Lead Hand | 165 |
| Lebsche Sternum Chisel | 187 |
| Legueu Bladder Spatula | 135 |
| Legueu Retractor | 146 |
| Leksell Bone Rongeur | 171 |
| Leksell Rongeur Forceps | 172 |
| Leksell-Stille Bone Rongeur | 169 |
| Lempert Bone Rongeur | 168 |
| Lempert Ear Curette | 208 |
| Lerche Tissue Forceps | 82 |
| Leriche Haemostatic Forceps | 54 |
| Leriche Retractor | 131 |
| Lewin Bone Holding Forceps | 155 |
| Lewis Rasp | 223 |
| Lexer Dissecting Scissors | 36 |
| Lexer-Baby Scissors | 36, 37 |
| Leyla Brain Retractor | 190 |
| Lichtenberg Needle Holders T.c. | 297 |
| Lichtenberg Needle Holders | 99 |
| Lichtwitz Antrum Trocar | 16 |
| Ligature Needle | 154 |
| Lightweight-Adson Tissue Forceps | 87 |
| Lister Bandage Operating Scissors T.c. | 295 |
| Lister Bandage Scissors | 51 |
| Lister Bougies Urethral Catheters | 290 |
| Lister Haemostatic Forceps | 73 |
| Lister Scissors | 51 |
| Liston Bone Cutting Forceps | 173, 174 |
| Liston Dissecting Knife | 28 |
| Liston-Key (Horsley) Bone Cutting Forceps | 175 |
| Littauer / Liston Bone Cutting Forceps | 173 |
| Littauer Scissors | 44 |
| Little Retractor | 114 |
| Littler Scissors | 39 |
| Lockhart-Mummery Probe | 149 |
| Locklin Scissors | 41 |
| Lockwood Intestinal Forceps | 241 |
| Lopez-Reinke Tonsil Dissector Suction Device | 16 |
| Lorna Towel Forceps | 75 |
| Love Modif. Retractor | 203 |

| DESCRIPTION | PAGE # |
|---------------------------------------|----------|
| Love Nerve Retractor | 203 |
| Love-Gruenwald Rongeur | 192 |
| Love-Kerrison Laminectomy Punch | 196 |
| Lower Haemostatic Forceps | 68 |
| Lowman-Hoglund Clamp | 155 |
| Lowmann Bone Clamp | 155 |
| Lubet-Barbon Septum Forceps | 221 |
| Luc Septum Forceps | 222 |
| Lucae / Ent Dressing Forceps | 85 |
| Lucae Ear Forceps | 216 |
| Lucae Ear Hooklet | 210 |
| Lucae Mallet | 164 |
| Lucae Tuning Fork | 205, 206 |
| Lucae Tympanum Needle | 207 |
| Lucas Bone Curette Double-ended | 162 |
| Luer Bone Rongeur | 167, 168 |
| Luer Hook | 234 |
| Luer Lock Adapter | 16 |
| Luer Retractor | 117 |
| Luer Tracheal Tube | 236 |
| Lukens Hook | 234 |
| Lukens Hooklet | 108 |

M

| | |
|---|-----|
| Mac + Miller Combo Set | 08 |
| Mac Disposable Set | 09 |
| Mac Fiberoptic Set | 09 |
| Macphail Needle Holders | 98 |
| Magill Catheter Introducing Forceps | 03 |
| Maltz Rasp | 223 |
| Mannerfelt Hook | 102 |
| Mannerfelt-Langenbeck Hook | 102 |
| Marquardt Bone Rongeur | 171 |
| Martel Haemostatic Forceps | 52 |
| Martin Applicator | 150 |
| Martin Pelvimeter | 284 |
| Martin Retractor | 132 |
| Martin Uterine Sounds | 271 |
| Martin Vaginal Specula | 260 |
| Mathieu Intestinal Rectal Specula | 249 |
| Mathieu Needle Holders | 98 |
| Mathieu Retractor | 117 |
| Mathieu Vaginal Retractor | 257 |
| Mathieu Vaginal Speculum | 256 |



INDEX

| DESCRIPTION | PAGE # |
|---|-------------|
| Mayfield Bone Rongeur..... | 169, 171 |
| Mayo Dissecting Scissors | 34 |
| Mayo Operating Scissors T.C | 294 |
| Mayo Rochester Needle Holders..... | 98 |
| Mayo Uterine Sounds | 271 |
| Mayo-Blake Gall Stone Forceps..... | 292 |
| Mayo-Collin Retractor | 119 |
| Mayo-Hegar Needle Holders T.c. | 296 |
| Mayo-Hegar Needle Holders | 95 |
| Mayo-Noble Dissecting Scissors | 34 |
| Mayo-Robson Intestinal Clamps..... | 244 |
| Mayo-Stille Dissecting Scissors | 34 |
| Mayo-Stille Operating Scissors T.c..... | 295 |
| Mc Indoe Bone Cutting Forceps..... | 174 |
| Mc Indoe Scissors | 43 |
| Mc Kenzie Spherical Burr | 191 |
| Mcindoe Dressing Forceps..... | 87 |
| Mcintosh Fiber Optic Laryngoscope Set..... | 04 |
| Mcintosh Laryngoscope Set | 07 |
| Mcivor Mouth Gage | 231 |
| Mclean Obstetrical Forceps..... | 285 |
| Mead Bone Rongeur | 167 |
| Mead Mallet..... | 164 |
| Meeker Haemostatic Forceps..... | 62 |
| Metzenbaum Dissecting Scissors..... | 35, 36 |
| Metzenbaum Needle Holders | 96 |
| Metzenbaum-Baby Scissors..... | 36 |
| Metzenbaum-Jamison Dissecting Scissors | 35 |
| Meyerding Retractor | 116, 133 |
| Micro Alligator Forceps | 200 |
| Micro Forceps..... | 89, 90 |
| Micro Grasping Forceps | 200 |
| Micro Scissors | 48, 49, 215 |
| Micro Tissue Forceps | 89 |
| Micro-Ear Forceps | 213 |
| Micro-Mosquito / Petit Point Haemostatic Forceps..... | 55 |
| Micro-Mosquito Haemostatic Forceps | 55 |
| Middeldorpf Retractor | 113, 115 |
| Mikulicz Tissue Forceps | 73 |
| Mikulicz Retractor | 127 |
| Miller Alveotomy File..... | 160 |
| Miller Disposable Set..... | 09 |
| Miller Fiberoptic Set..... | 09 |
| Miller Hook..... | 104 |
| Miller Rasp..... | 223 |
| Miller-Colburn Bone File..... | 160 |

| DESCRIPTION | PAGE # |
|--|----------|
| Miller-Colburn Rasp..... | 223 |
| Millin's Suction Tube..... | 12 |
| Milne Murray Obstetrical Forceps..... | 286 |
| Mini Otoscope Set | 05 |
| Mini-Lambotte Osteotome | 159 |
| Mini-Roux Retractor..... | 118 |
| Mini-Townsend Uterine Biopsy Forceps | 278 |
| Mirco Cup Forceps | 200 |
| Mixer Haemostatic Forceps..... | 67 |
| Mixer Operating Scissors | 33 |
| Mod. Martin Dressing Forceps | 80 |
| Mod. USA Tissue Forceps | 83 |
| Modell Piccolo Applicator..... | 149 |
| Modell Tubingen Retractor | 132 |
| Modell USA Tissue Forceps | 87 |
| Modell USA Dressing Forceps..... | 87 |
| Modell Wurzburg Mouth Gage..... | 231 |
| Modified Wien Nasal Speculum..... | 217, 220 |
| Modified-USA Scissors | 51 |
| Mollison Retractor..... | 140 |
| Molt Mouth Gag | 229 |
| Morris-De Bakey Vascular Clamp..... | 179 |
| Morse-Favaloro Sternal Retractor | 185 |
| Moynihan Artery Forceps..... | 72 |
| Moynihan Gall Duct Dilator..... | 289 |
| Murphy Retractors | 106 |
| Museux Tenaculum Forceps..... | 265 |
| Museux Tonsil Forceps | 232 |
| Myrtle Leaf Probe | 150 |

N

| | |
|--|---------|
| Nabatoff Varicose Vein Probe Set Complete..... | 189 |
| Naegele Obstetrical Forceps | 285 |
| Naegele Uterine Biopsy Forceps..... | 281 |
| Nail Nipper..... | 151 |
| Nail Scissors..... | 45 |
| Nasal Suction Tube | 16, 227 |
| Needle Holders..... | 98 |
| Needle Nose Pliers..... | 165 |
| Negus Haemostatic Forceps | 72 |
| Nelaton Probe..... | 149 |
| Nelson Abdominal Trocar | 17 |
| Nelson Lung Dissecting Scissors | 43 |
| Nelson Tissue Forceps | 84 |



INDEX

| DESCRIPTION | PAGE # |
|-------------------------------------|--------|
| Nelson Trocar | 18 |
| Nerve Root Retractor | 203 |
| Nerve Separator & Spatula..... | 201 |
| Neuro-Duoflex Hammer..... | 01 |
| New Orleans Needle Holders | 97 |
| New Port Vaginal Speculum | 262 |
| Non-Perforating Towel Forceps | 74 |
| Nott Vaginal Specula | 253 |
| Novak Suction Cannula Curette | 272 |
| Noyes Micro Scissors | 46 |
| Noyes Scissors..... | 48 |

O

| | |
|---|--------|
| O'Shaughnessy Haemostatic Forceps | 62 |
| O'Sullivan - O'Connor Vaginal Speculum | 263 |
| O'Sullivan/O'Connor Retractor | 145 |
| Ochsner Gall Bladder Trocar | 18 |
| Olivecrona Nasal Scissors..... | 222 |
| Operating Fine Scissors | 43 |
| Ortho Forceps..... | 155 |
| Otoscope / Ophthalmoscope Set..... | 05 |
| Otoscope Set | 05, 06 |
| Overholt-Geissendoerfer Haemostatic Forceps | 64 |

P

| | |
|---|-----|
| Parametrium Haemostatic Forceps | 70 |
| Parker Retractor | 119 |
| Parker-Langenbeck Retractor..... | 119 |
| Parker-Mott Retractor | 119 |
| Partsch Chisel | 157 |
| Partsch Gouge..... | 157 |
| Partsch Mallet..... | 164 |
| Payr Intestinal Clamps..... | 247 |
| Payr-Baby Intestinal Clamps | 247 |
| Pean-Delicate Haemostatic Forceps | 58 |
| Pean Haemostatic Forceps | 57 |
| Pederson Vaginal Specula | 251 |
| Pederson Vaginal Speculum | 251 |
| Peers-Bertman Towel Forceps | 75 |
| Peet Splinter Forceps | 94 |
| Pennington / Siezing Haemostatic Forceps..... | 52 |
| Percy Retractor..... | 161 |

| DESCRIPTION | PAGE # |
|--|--------|
| Periosteal Elevator | 157 |
| Perkins Retractor..... | 142 |
| Pinard Aluminium Stethoscope..... | 03 |
| Piper Obstetrical Forceps | 285 |
| Pituitary Laminectomy Rongeur | 198 |
| Plaster-Brun..... | 176 |
| Plester Knife | 209 |
| Plester Retractor..... | 142 |
| Plester Suction Tube | 227 |
| Ploitzer Ear Specula | 204 |
| Politzer Tympanum Needle | 207 |
| Pool Suction Tube | 12 |
| Poots-Smith Dressing Forceps | 81 |
| Potts Tenotomy Scissors | 40 |
| Potts-Reynolds Tenotomy Scissors | 40 |
| Potts-Smith Dressing Forceps T.C | 298 |
| Potts-Smith Scissors | 42, 43 |
| Potts-Smith Tissue Forceps | 82 |
| Pozzi Gyne Uterine Tenaculum Forceps | 264 |
| Pozzi Tonsil Forceps..... | 233 |
| Pratt Gyne Uterine Dilators..... | 273 |
| Pratt Haemostatic Forceps..... | 52 |
| Pratt Intestinal Rectal Specula | 249 |
| Pratt Uterine Polypus Forceps..... | 265 |
| Probe | 150 |
| Providence / Hospital Haemostatic Forceps..... | 58 |

Q

| | |
|--------------------------------|-----|
| Quire Ear Polypus Forceps..... | 211 |
|--------------------------------|-----|

R

| | |
|------------------------------------|-----|
| Rabiner Hammer | 02 |
| Ragnell-Davis Retractor | 109 |
| Ralk Splinter Forceps | 94 |
| Ramathibodi Uterin Sounds..... | 262 |
| Ramplsey Sponge Forceps | 77 |
| Randall Kidney Stone Forceps | 287 |
| Razor Hollow Blade | 30 |
| Recamier Uterine Curette..... | 269 |
| Reiner Ear Syringe | 211 |
| Resection Knife | 30 |
| Reverdin Needle..... | 152 |



INDEX

| DESCRIPTION | PAGE # | DESCRIPTION | PAGE # |
|--|----------|---|----------|
| Reynolds Scissors | 37 | Scalp-Contour Retractor..... | 140 |
| Rib Shear..... | 187 | Scalpel Handle | 22, 23 |
| Ricard Retractor | 146 | Scalpel Handle #3 | 21 |
| Richardson Eastman Retractor..... | 117 | Scalpel Handle #3 | 22 |
| Richardson/Kelly Retractor..... | 133 | Scalpel Handle #4 | 21 |
| Richardson-Eastman Retractor | 138 | Scalpel Handle #4L | 21 |
| Richter Scissors | 34 | Scalpel Handle #7 | 22 |
| Riechert Fixation Base | 190 | Scalpel Handle / Long Angled #3 | 22 |
| Roberts Haemostatic Forceps | 66 | Scalpel Handle 3L Long | 22 |
| Rochester / Carmalt Haemostatic Forceps..... | 58 | Scalpel Handle | 23 |
| Rochester / Ochsner / Kocher Haemostatic Forceps | 60 | Scalpel Handle/Graduated #3 | 21 |
| Rochester / Pean Haemostatic Forceps..... | 59 | Scalpel Plastic Handle..... | 21 |
| Roeder Towel Forceps..... | 74 | Scheinmann Forceps Exchangeable Tip..... | 239 |
| Rollet (Blair) Hook | 104 | Scherback Vaginal Specula..... | 261 |
| Rollet Hook | 101, 104 | Schindler Haemostatic Forceps..... | 72 |
| Rose Retractor..... | 117 | Schlesinger Laminectomy Rongeur..... | 194 |
| Rosen Hook..... | 209 | Schmeden Nasal Cutting Forceps..... | 226 |
| Rosen Tympanum Needle | 210 | Schmieden Needle | 153 |
| Rosenbrg Forceps Exchangeable Tip | 239 | Schmieden-Dick Needle | 153 |
| Roser-Konig Mouth Gag..... | 229 | Schmidt / Sawtell Haemostatic Forceps | 62 |
| Ross Retractor..... | 134 | Schoenborn Hook..... | 234 |
| Roux Retractor..... | 118 | Schoenborn Retractor..... | 116 |
| Roux-Magnus Retractor..... | 118 | Schröder Gyne Uterine Tenaculum Forceps | 264 |
| Rumel Haemostatic Forceps | 65 | Schröder Uterine Tenaculum Forceps | 264 |
| Ruskin Bone Rongeur | 170, 171 | Schroeder Suction Curettes | 267 |
| Ruskin Bone Splitting Forceps | 175 | Schroeder Tonsil Forceps..... | 232, 233 |
| Ruskin-Liston Bone Cutting Forceps | 174 | Schubert Uterine Biopsy Forceps | 280 |
| Ruskin-Mini Bone Rongeur..... | 170 | Schuknecht Hook | 209 |
| Russian-Modell Dressing Forceps..... | 85 | Schuknecht Knife..... | 209 |
| Rydel-Seiffer Tuning Fork..... | 206 | Schulze-Bergmann Intestinal Rectal Specula | 250 |
| S | | | |
| Sachs Hook | 201 | Schumacher Sternum Shear | 187 |
| Saenger Placenta Forceps | 282 | Schumacher Uterine Biopsy Forceps..... | 276 |
| Sairges Tenaculum Forceps | 265 | Schumacher-Nan-Doren Uterine Biopsy Forceps | 281 |
| Samii Tissue Forceps | 88 | Scoville Bone Curette | 162 |
| Sanvenero Scissors..... | 37 | Scoville Nerve Hook And Dissector..... | 201 |
| Satinsky Vascular Clamp..... | 181 | Scoville Nerve Root Retractor | 203 |
| Satterlee Amputation Saw | 161 | Scoville Sympathectomy Hook & Dissector..... | 201 |
| Satterlee Saw | 30 | Screw Nut Wrench | 166 |
| Sauerbruch Rib Shear | 188 | Segond Myoma Knife | 266 |
| Sauerbruch Rongeur Forceps | 172 | Sellers Rib Contractor | 182 |
| Sauerbruch-Frey Sternum Shear | 187 | Semb Bone Cutting Forceps | 175 |
| Sawtell Haemostatic Forceps | 62 | Semb Bone Rongeur | 170 |
| | | Semken Dressing Forceps | 81 |
| | | Semken Tissue Forceps | 83 |
| | | Semm Vaginal Specula | 253 |
| | | Semm Retractor | 147 |



INDEX

| DESCRIPTION | PAGE # |
|--|----------|
| Senn Mallow Retractor | 108 |
| Senn Mueller Retractor..... | 108 |
| Senn-Green Retractor | 109 |
| Senning Needle Holders T.c..... | 296 |
| Senning Needle Holders..... | 97 |
| Seutin Shear..... | 176 |
| Sexton Tympanum Needle | 207 |
| Seyffert Vaginal Specula | 252 |
| Shapleigh Ear Curette | 208 |
| Simon / Schroder Uterine Scoops | 268 |
| Simon Bone Curette | 162 |
| Simon Dissecting Knife..... | 28 |
| Simon Hook..... | 103 |
| Simon Retractor..... | 132 |
| Simon Vaginal Speculum..... | 256 |
| Simpson Obstetrical Forceps | 285 |
| Simpson Uterine Sounds..... | 271 |
| Simpson-Braun Obstetrical Forceps | 285 |
| Sims Intestinal Rectal Specula | 249 |
| Sims Scissors | 38 |
| Sims Uterine Curette | 270, 272 |
| Sims Uterine Scoops | 267, 271 |
| Sims Uterine Sounds..... | 271 |
| Sims-Special Uterine Sounds..... | 271 |
| Singley-Tuttle Dressing Forceps | 85 |
| Singley-Tuttle Intestinal Dressing Forceps | 85 |
| Skene Tonsil Forceps | 233 |
| Slip Joint Plier..... | 165 |
| Sluder-Ballenger Tonsillotome Forceps..... | 234 |
| Smellie Uterine Biopsy Forceps | 281 |
| Smith (Mod. USA) Scissors | 51 |
| Smith Peterson Gouge | 158 |
| Smith Peterson Osteotome | 158 |
| Smith-Blue Intestinal Rectal Specula | 250 |
| Snellen Currete..... | 209 |
| Spatula | 149 |
| Speaking Tube..... | 236 |
| Spencer / Delicate Scissors..... | 44 |
| Spencer Scissors..... | 44 |
| Spencer-Wells Haemostatic Forceps | 61 |
| Splinter Forceps | 93, 94 |
| Spratt / Hollow Handle Bone Curette..... | 163 |
| Spurling Laminectomy Rongeur | 194 |
| S-Shaped Retractor..... | 126 |
| St. Marks Retractor..... | 136 |
| Standard Dressing Forceps T.c..... | 298 |

| DESCRIPTION | PAGE # |
|--|----------|
| Standard Dressing Forceps..... | 79, 80 |
| Standard Narrow Dressing Forceps | 80 |
| Standard Operating Scissors T.c..... | 294 |
| Standard Operating Scissors..... | 31, 32 |
| Standard Tissue Forceps T.c..... | 298 |
| Standard Tissue Forceps..... | 79 |
| Standard Trocar..... | 17 |
| Staude-Moore Tonsil Forceps..... | 233 |
| Stellbrink Synovctomy Rongeur | 167 |
| Sternberg Retractor | 109 |
| Stevens Micro Forceps..... | 90 |
| Stevens Tissue Forceps | 91 |
| Stieglitz Forceps | 94 |
| Stieglitz Splinter Forceps..... | 94 |
| Stille Bone Rongeur..... | 170 |
| Stille Dressing Forceps..... | 80 |
| Stille Gouge | 158 |
| Stille Osteotome | 158 |
| Stille Rongeur Forceps | 172 |
| Stille Shear | 176 |
| Stille-Listo Bone Cutting Forceps | 174 |
| Stille-Liston Bone Cutting Forceps | 174 |
| Stille-Luer Bone Rongeur | 169 |
| Stille-Luer Rongeur Forceps..... | 172 |
| Stille-Ruskin Bone Rongeur | 169 |
| Stone Tissue Forceps | 82 |
| Strabismus Scissors | 39 |
| Strandell-Stille Retractor..... | 109, 116 |
| Stratte Needle Holders | 97 |
| Strümpel Alligator Ear Forceps..... | 212 |
| Struycken Forceps Exchangeable Tip..... | 239 |
| Struycken Nasal Cutting Forceps | 226 |
| Struycken Septum Forceps | 221 |
| Suction Raspatory | 16 |
| Suction Tube..... | 13 |

T

| | |
|-----------------------------------|-----|
| Takahashi Tonsil Punch | 226 |
| Tarnier Obstetrical Forceps | 286 |
| Taylor Dressing Forceps | 81 |
| Taylor Hammer | 01 |
| Taylor Spinal Retractor | 117 |
| Taylor Tissue Forceps | 83 |
| Teale Tonsil Forceps..... | 232 |



INDEX

| DESCRIPTION | PAGE # |
|---|--------------------|
| Teale Uterine Polypus Forceps..... | 265 |
| Tendon Hook..... | 116 |
| Terrier Haemostatic Forceps | 58 |
| Thin Footplate Kerrison Punch..... | 197 |
| Thole Pelvimeter..... | 284 |
| Thoms-Gaylor Uterine Biopsy Forceps | 280 |
| Thoracic & I.M.A Rib Retractor | 186 |
| Thoracic Retractor | 186 |
| Thorek-Feldman Gall Bladder Scissor..... | 36 |
| Thudichum (Golfsmith) Nasal Speculum | 218 |
| Tieck-halle Nasal Speculum | 219 |
| Tischler Uterine Biopsy Forceps..... | 275, 278, 279, 280 |
| Tischler-Kevorkian Uterine Biopsy Forceps | 275 |
| Tischler-Morgan Uterine Biopsy Forceps | 279 |
| Tissue & Dressing Forceps | 81, 85, 87, 91 |
| Tissue Forceps | 83, 84 |
| Tissue Forceps T.c..... | 298 |
| Toennis Haemostatic Forceps | 65 |
| Toennis Hook..... | 101, 201 |
| Toennis Needle Holders | 99 |
| Tohoku Towel Forceps..... | 75 |
| Tongue Depressor | 228 |
| Tracheotomy Set | 237 |
| Traction Cable | 189 |
| Traube Hammer | 02 |
| Trelat Vaginal Specula..... | 253 |
| Trocars & Suction Tubes | 16 |
| Troeltsch Ear Forceps | 216 |
| Troutman Micro Scissors..... | 47 |
| Tubbs Aortic Dilator | 183 |
| Tuffier Haemostatic Forceps..... | 52 |
| Tuffier Retractor | 128, 185, 186 |
| Turner-Doyen Retractor | 134 |

U

| | |
|---|-----|
| Uffendorde Bone Curette Left & Right..... | 162 |
| Ulrich Bone Holding Forceps..... | 156 |
| Universal Bandage Scissors..... | 50 |
| Universal Trocar | 16 |
| USA Retractor..... | 117 |
| US-Army Retractor | 117 |
| Utility Shear | 176 |
| Utility Shears Scissors | 51 |

| DESCRIPTION | PAGE # |
|---|----------|
| V | |
| Valleix Uterine Sounds | 271 |
| Van Buren Urethral Catheters | 290 |
| Van Doren Uterine Biopsy Forceps | 281 |
| Vanderbilt / Vessel Clamp Forceps..... | 54 |
| Vezien Scissors | 38 |
| Vickers Mallet | 164 |
| Vienna Nasal Speculum | 220 |
| Virchow Dissecting Knife | 29 |
| Vogel Dilation Forceps..... | 18 |
| Volkman Retractor | 108 |
| Volkman Bone Curette..... | 163 |
| Volkman Hooklet..... | 106,107 |
| Volkman Retractor | 120, 121 |
| Vollmar Ring Stripper..... | 150 |
| Voltolini (Duplay) Nasal Speculum | 218 |

W

| | |
|---|-----|
| Wagener Ear Hooklet | 210 |
| Walb Dissecting Knife..... | 29 |
| Wallich Ovum Forceps | 282 |
| Walton Scissors | 44 |
| Walton-Liston Bone Cutting Forceps..... | 174 |
| Wangensteen Dressing Forceps | 81 |
| Wangensteen Tissue Forceps | 298 |
| Wartenberg Hammer | 02 |
| Wassmund Retractor | 114 |
| Watson-Williams Sphenoid Bone Punch | 225 |
| Watson-Williams Tonsil Punch..... | 226 |
| Weber Aesthesiometer | 03 |
| Webster Needle Holders | 95 |
| Wecker Micro Scissors | 46 |
| Weil-Blakesley Laminectomy Rongeur..... | 199 |
| Weil-Blakesley Sphenoid Bone Punch | 225 |
| Weinberg Vagotomy Retractor (Joe's Hoe) | 134 |
| Weingärtner Alligator Ear Forceps..... | 212 |
| Weissbarth Retractor..... | 259 |
| Weitlaner Retractor..... | 142 |
| Westcott Micro Scissors | 47 |
| Westcott Scissors | 48 |
| Westmacott Septum Forceps | 221 |
| Wetheim Scissors..... | 38 |



INDEX

| DESCRIPTION | PAGE # |
|---|--------|
| Whitehead Mouth Gag With Tongue Depressor | 230 |
| Whitehead-Jennings Mouth Gag | 230 |
| Wiener Hook..... | 101 |
| Wilde Intervertebral Disc Rongeur..... | 199 |
| Wilde Nasal Polypus Snare | 222 |
| Willet-Martel Haemostatic Forceps..... | 52 |
| Willet Obstetrical Forceps..... | 283 |
| Williams Intestinal Forceps..... | 240 |
| Williger Bone Curette..... | 163 |
| Williger Mallet | 164 |
| Williger Periosteal Elevator..... | 156 |
| Wilmer Iris Scissors | 40 |
| Winkelmann Circumcision Clamps | 293 |
| Winter Placenta Forceps | 282 |
| Winterton Vaginal Specula | 253 |
| Wire Cutter | 176 |
| Wire Cutting Scissors | 45 |
| Wire Retaining Retractor | 139 |
| Wittner Uterine Biopsy Forceps..... | 277 |
| Wrigley Obstetrical Forceps | 286 |
| Wullstein Micro Ear Forceps..... | 214 |
| Wullstein Suction Tube | 19 |

Y

| | |
|--|----------|
| Yankauer Suction Tube | 14 |
| Yasargil Lure-Lock Cone | 20 |
| Yasargil Suction Tube..... | 19 |
| Yeomann Polyous Grasping Forceps | 246 |
| Young Needle | 153 |
| Young Prostatic Retractor..... | 137, 288 |
| Young Retractor..... | 137 |

Z

| | |
|---------------------------------|-----|
| Zaufal Ear Hooklet..... | 210 |
| Zaufal-Jansen Bone Rongeur..... | 170 |
| Zenker Retractor | 111 |

| DESCRIPTION | PAGE # |
|-------------|--------|
|-------------|--------|



Allegro Surgical Corporation

Manufacturers & Exporters of Surgical, Dental Instruments & Holloware

Head Quarter:

ALLEGRO SURGICAL CORP.
Bismillah Chowk, Pasrou Road,
SIALKOT - 51310 PAKISTAN.

Unit:

Jinnah Islamia College Road,
SIALKOT - 51310 PAKISTAN.

Tele No: +92-52-4596242, 4583234

Fax No: +92-52-4597345

E-mail : info@allegro.com.pk

URL : www.allegro.com.pk